

50p

# Practical Computing

November 1979

Volume 2 Issue 11

Computers for  
the radio amateur

Pattern recognition

Fault diagnosis

Review:  
Rair Black Box

Programmer  
of the Year



Ask for our  
free colour  
brochure

DIAL  
NOW

031-225 2022  
(24 HOURS ANSWERING)

# MicroCentre are the UK Cromemco experts

## Sample catalogue prices:

*System Two computer	1995
*System Three computer	3293
*Z-2H computer	4998
Extra 64K memory	893
3101 visual display unit	1147
3355 daisywheel printer	2297
HDD 11-mbytes hard disc	4022
ANSI Cobol compiler	55
ANSI Fortran IV compiler	55
16K extended Basic	55
Word processing system	55
Database management	55
Macro relocating assembler	55
Prices exclude VAT and delivery	

MicroCentre also supply peripherals, applications software, and multi-user timesharing systems; a PROM programmer; analogue-digital interface; and much more. On site maintenance can be arranged throughout the UK.  
\*Computer systems include fast 4MHz Z80A micro, S-100 bus (21 slots), 64K memory, dual floppy discs, peripheral interfaces, etc. CP/M compatible operating system CDOS free with software.

With our in-depth experience and total commitment to the reliable Cromemco range we are Cromemco's leading UK distributor. Rely on us, as many others do, for expert support with your routine or special micro-computer applications.

*Photo features Cromemco System 3 computer, 3101 VDU, and 3355 daisywheel printer.*

**Look out for us at Compec '79, stand no. 756**

2

## Micro Centre

Complete Micro Systems Ltd.  
132 St. Stephen Street,  
Edinburgh EH3 5AA.  
Tel: 031-225 2022.

● Circle No. 101

Editor  
**Peter Laurie**

Technical Editor  
**Nick Hampshire**

Staff Writer  
**Duncan Scot**

Advertisement  
Department  
**Tom Moloney**  
**Tina Roberts**

Publishing Director  
**Christopher Hipwell**

Editorial: 01-261 8894  
Advertising: 01-261 8000

Practical Computing is  
published by IPC Electrical  
Electronic Press Ltd,  
Dorset House, Stamford  
Street, London SE1 9LU.  
Tel: 01-261 8000

Telegrams/Telex: 25137  
BISPRSG

and printed by  
Eden Fisher Ltd,  
Southend-on-Sea.

Distributed by  
IPC Sales and Distribution Ltd,  
40 Bowling Green Lane,  
London, EC1R 0NE.  
Typesetting & Artwork  
by Bow-Towning Ltd,  
London EC1.

Subscription Rates:  
Single copy: 50p.  
Subscriptions: U.K.,  
£6 per annum  
(including airmail postage).  
Europe (excluding U.K.), £12;  
Elsewhere in the world: £18.

Subscription Enquiries:  
Subscription Manager  
IPC Business Press (S. and D.)  
Ltd.  
Oakfield House,  
Perrymount Road,  
Haywards Heath,  
Sussex RH16 3DH.  
Tel: 0444 59188.

©IPC Business Press Ltd 1979  
ISSN 0141-5433.  
Every effort has been made to  
ensure accuracy of articles and  
program listing. Practical  
Computing cannot, however,  
accept any responsibility  
whatsoever for any errors.

## COMPUTERS FOR THE RADIO AMATEUR

Updating the first electronic hobby ..... 60

## REVIEW I

Vincent Tseng examines the Rair Black Box ..... 67

## REVIEW II

Tecs is the system if you want to be a pioneer ..... 70

## ARTIFICIAL INTELLIGENCE

Mark Witowski on the problems of making computers learn ..... 76

## PROGRAM OF THE YEAR

Microaid, the winning entry in our competition ..... 120

## FINANCIAL MODELLING

An up-to-date look at corporate planning ..... 84

## FILE-HANDLING TECHNIQUES

The hard-sectoring approach under examination ..... 90

## SOLVING CHIP PROBLEMS

The process of testing for failures ..... 94

## ALL THIS AND MORE

FEEDBACK .....	53	BOOK REVIEWS .....	111
PRINTOUT .....	59	DIARY .....	115
SOFTWARE ON DISC .....	72	TANDY FORUM .....	117
STRUCTURED PROGRAMMING .....	80	PET CORNER .....	119
PET IN THE REAL WORLD .....	87	COMPUTABITS .....	136
GAME .....	101	BUYERS' GUIDE .....	143
STATISTICS ON A MICRO .....	106	GLOSSARY .....	151
PEEK n' POKE .....	108	ADVERTISEMENT INDEX .....	181

PET  
Z80/CPM  
6800

# SOFTWARE

*This is how your business appears on the screen.  
Approx 60 entries update require only 1-2 hours weekly and  
your entire business is under control.*



**\* PROGRAMS ARE INTEGRATED**

- 1 = ENTER NEW NAMES/ADDRESSES
- 2 = \* ENTER/PRINT INVOICES
- 3 = \* ENTER PURCHASES
- 4 = \* ENTER A/C RECEIVABLES
- 5 = \* ENTER A/C PAYABLES
- 6 = ENTER/UPDATE STOCKS REC'D
- 7 = ENTER ORDERS REC'D
- 8 = EXAMINE/UPDATE BANK BALANCE
- 9 = EXAMINE SALES LEDGER
- 10 = EXAMINE PURCHASE LEDGER
- 11 = EXAMINE INCOMPLETE RECORDS
- 12 = EXAMINE PRODUCE SALES

WHICH ONE (ENTER 1 TO 24)

EACH PROGRAM GOES IN DEPTH TO FURTHER EXPRESS YOUR REQUIREMENTS.

FOR EXAMPLE (9) ALLOWS: a. list all sales; b. monitor sales by stock code; c. invoice search; d. amend ledger files; e. total all sales.

BUSINESS PROGRAM VERSION 1 ..... £275  
(VERBOSE SIMPLE LANGUAGE AND UNITARY  
FILE HANDLING)

BUSINESS PROGRAM VERSION 2 ..... £375  
(MORE IMPENETRABLE VALIDATIONS AND  
PROTECTION)

MULTI-MODE 1, MULTI-FUNCTION, 12 STRING  
HANDLER..... £50

**SELECT FUNCTION BY NUMBER**

- 13 = PRINT CUSTOMER STATEMENTS
- 14 = PRINT SUPPLIER STATEMENTS
- 15 = PRINT AGENTS STATEMENTS
- 16 = PRINT QUARTERLY TAX STATEMENTS
- 17 = PRINT WEEK/MONTH SALES
- 18 = PRINT WEEK/MONTH PURCHASES
- 19 = PRINT YEAR AUDIT
- 20 = PRINT PROFIT/LOSS ACCOUNT
- 21 = UPDATE ENDMONTH FILES
- 22 = PRINT CASHFLOW ANALYSIS
- 23 = ENTER PAYROLL
- 24 = RETURN TO BASIC

BUSINESS PROGRAM VERSION 3 ..... £475  
(SPACE SAVING AND MULTI MODE AND  
FUNCTION PROGRAMS)

BUSINESS PROGRAM VERSION ..... £575  
(INCLUDING PAYROLL, YEAR AUDIT, PRO'  
LOSS; CASHFLOW)

MULTI-MODE 2, MULTI-FUNCTION, 12 STRING  
HANDLER & NUMERIC COMBINER ..... £100



# HARDWARE



**• PET 2001 SERIES**

- PET Computer 2001 32K ..... £795
- PET Printer 3022 Tractor Feed ..... £645
- PET Floppy Disks 2040 ..... £795
- PET IEEE Cables ..... £ 45

**• TERMINALS**

- Hazeltine 1510 ..... £895
- Interlube Video Terminal ..... £595
- Soroc IQ120 ..... £695

**• PRINTERS**

- Teletype 43 Printer ..... £895
- Centronics 779 Printer ..... £950

**• COMPUTERS**

**Intertec Superbrain**

- Dual Z-80A Vector Interrupt, 64K RAM  
pws 1K 2708 PROM Bootstrap, Two  
Double-Density 5in. Floppy Disks  
..... £1,950

**Industrial Micro Systems Z-80 System**

- 48K Expands to 594K; Twin D/D Disk  
included. Expands to 10 Meg and pro-  
grams are CPM compatible ..... £2,500

**Smoke Signal 6800 System**

- 32K Expandable + Twin D/S  
Discs..... £2,500

Please telephone for appointment — Tony Winter 01-636 8210

G.W. Computers Ltd., 89 Bedford Court Mansions, Bedford Avenue, London WC1.

# The Cromemco

# Z-2H

**NEW**  
from Comart



**11 Megabytes of hard disc storage in a fast, new, table-top computer.**

- Fast Z80A 4MHz processor
- 11-megabyte hard disc drive
- Two floppy disc drives
- 64K RAM memory
- RS-232 serial interface
- Printer interface
- Extensive software available

Contact us direct or call your nearest Comart dealer

CAMBRIDGE  
CAMBERLEY  
ILFORD

LEEDS

LONDON  
LUTON  
MANCHESTER

NEWBURY

NEWPORT  
NOTTINGHAM

SHEFFIELD  
SOUTHAMPTON

CAMBRIDGE COMPUTER STORE, Cambridge (0223) 68155

MICROBITS, Camberley Surrey (0276) 34044

THE BYTE SHOP, Ilford Essex 01-554 2177

also at Tottenham Court Road London 01-636 0647

HOLDENE LIMITED, Leeds (0532) 459459

also at Wilmslow, Cheshire (0625) 529486

DIGITUS LIMITED, London W1 01-636 0105

ISHERWOODS, Luton, Bedfordshire (0582) 424851

MICROCOMPUTERMART, Manchester 1061-8321 2269

also at West Park, Leeds (0532) 788466

NEWBEAR COMPUTING STORE, Newbury Berks (0635) 30506

also at Stockport, Cheshire (061-491) 2290

MICROMEDIA, Newport, Gwent (0633) 50528

COMPUTERLAND LIMITED, Nottingham (0602) 40576

also at Birmingham (021 622) 7149

Manchester (061-834) 0220

Glasgow (041 332) 2468

HALLAM COMPUTER SYSTEMS, Sheffield (0742) 663125

XITAN SYSTEMS LIMITED, Southampton (0703) 38740



## comart specialists in microcomputers

Comart Ltd., P.O. Box 2, St. Neots, Huntingdon, Cambs, PE19 4NY. Tel: (0480) 215005 Telex: 32514

● Circle No. 103

# Even More!

Super software from the world's leading microsoftware supplier.

## DIGITAL RESEARCH

Software  
with / Manual  
Manual / Alone

- CP/M\* FDOS** — Diskette Operating System complete with Text Editor, Assembler, Debugger, File Manager and system utilities. Available for wide variety of disk systems including North Star, Helios II, Micropolis, iCOM (all systems) and Altair. Supports computers such as Sorcerer, Horizon, Sol System III, Versatile, Altair 8800, COMPAL-80, DYNABYTE DB8/2, and iCOM Attache. Specify desired configuration ..... **£75/£15**
- MAC** — 8080 Macro Assembler. Full Intel macro definitions. Pseudo Ops include RPC, IRP, REPT, TITLE, PAGE, and MACLIB. Z-80 library included. Produces Intel absolute hex output plus symbols file for use by SID (see below) ..... **£55/£10**
- SID** — 8080 symbolic debugger. Full trace, pass count and break-point program testing system with back-trace and histogram utilities. When used with MAC, provides full symbolic display of memory labels and equated values ..... **£45/£10**
- TEX** — Text formatter to create paginated, page-numbered and justified copy from source text files, directable to disk or printer ..... **£45/£10**
- DESPOOL** — Program to permit simultaneous printing of data from disk while user executes another program from the console ..... **£30/£7**

## MICROSOFT

- Disk Extended BASIC** — Version 5, ANSI compatible with long variable names, WHILE/WEND, chaining, variable length file records ..... **£155/£15**
- BASIC Compiler** — Language compatible with Version 5 Microsoft interpreter and 3-10 times faster execution. Produces standard Microsoft relocatable binary output. Includes Macro-80. Also linkable to FORTRAN-80 or COBOL-80 code modules ..... **£195/£15**
- FORTRAN-80** — ANSI '66 (except for COMPLEX) plus many extensions. Includes relocatable object compiler, linking loader, library with manager. Also includes MACRO-80 (see below) ..... **£205/£15**
- COBOL-80** — ANSI '74 Relocatable object output. Format same as FORTRAN-80 and MACRO-80 modules. Complete ISAM, interactive ACCEPT/DISPLAY, COPY, EXTEND ..... **£325/£15**
- MACRO-80** — 8080/Z80 Macro Assembler. Intel and Zilog mnemonics supported. Relocatable linkable output. Loader, Library Manager and Cross Reference List utilities included ..... **£75/£10**
- EDIT-80** — Very fast random access text editor for text with or without line numbers. Global and intra-line commands supported. File compare utility included ..... **£45/£10**

## XITAN (software requires Z80\*\* CPU)

- Z-TEL** — Text editing language. Expression evaluation iteration and conditional branching ability. Registers available for text and commands. Macro command strings can be saved on disk for re-use ..... **£40/£12**
- ASM** Macro Assembler — Mnemonics per Intel with Z-80 extensions. Macro capabilities with absolute Intel hex or relocatable linkable output modules. New version 3 with added features ..... **£40/£12**
- LINKER** — Link-edits and loads ASM modules ..... **£40/£12**
- Z-BUG** debugger — Trace, break-point tester. Supports decimal, octal and hex modes. Dissassembler to ASM mnemonic set. Emulation technique permits full tracing and break-point support through ROM ..... **£45/£12**
- TOP** Text Output Processor — Creates page-numbered, justified documents from source text files ..... **£40/£12**
- A4 package** includes Z-TEL, ASM, LINKER, Z-BUG, TOP ..... **£155/£30**

\*CP/M is a trade name of Digital Research  
\*\*Z80 is a trademark of Zilog, Inc.

## EIDOS SYSTEMS

Software  
with / Manual  
Manual / Alone

- KISS** — Keyed Index Sequential Search. Offers complete Multi-Keyed Index Sequential and Direct Access file management. Includes built-in utility functions for 16 or 32 bit arithmetic, string/integer conversion and string compare. Delivered as a relocatable linkable module in Microsoft format for use with FORTRAN-80 or COBOL-80; etc. .... **£275/£15**
  - K BASIC** — Microsoft Disk Extended BASIC with all KISS facilities, integrated by implementation of nine additional commands in language. Package includes KISS.REL as described above, and a sample mail list program ..... **£495/£30**
- ## MICROPRO
- Super-Sort I** — Sort, merge, extract utility as absolute executable program or linkable module in Microsoft format. Sorts fixed or variable records with data in binary, BCD, Packed Decimal, EBCDIC, ASCII, floating, fixed point, exponential, field justified, etc. etc. Even variable number of fields per record! ..... **£125/£15**
  - Super-Sort II** — Above available as absolute program only ..... **£105/£15**
  - Super-Sort III** — As II without SELECT/EXCLUDE ..... **£75/£15**
  - Word-Master Text Editor** — In one mode has super-set of CP/M's ED commands including global searching and replacing, forward and backwards in file. In video mode, provides full screen editor for users with serial addressable-cursor terminal ..... **£75/£15**

- Word-Star** — Menu driven visual word processing system for use with standard terminals. Text formatting performed on screen. Facilities for text paginate, page number, justify, center, underscore and PRINT. Edit facilities include global search and replace, read/write to other text files, block move, etc. Requires CRT terminal with addressable cursor positioning ..... **£255/£15**

## GRAFFCOM SYSTEMS

- PAYROLL** — Designed in conjunction with the spec for PAYE routines by HMI Taxes. Processes up to 250 employees on weekly or monthly basis. Can handle cash, cheque or bank transfer payments plus total tracking of all year to date figures. Prints emp master, payroll log, payslips and bank giros. Requires CBASIC-2 ..... **£475/£15**
- COMPANY SALES** — Performs sales accounting function. Controls payments of invoices and prints sales ledger and aged debtors report. Suitable for any accounting period. Comprehensive VAT control and analysis of all sales invoices. Requires CBASIC-2. .... **£425/£15**
- COMPANY PURCHASES** — Performs purchase accounting function. Controls invoices, credit & debit notes. Prints purchase ledger, aged creditors report and payment advices. Comprehensive VAT control and analysis of all purchases. Interfaces with the NAD system. Requires CBASIC-2. .... **£425/£15**
- STOCK CONTROL**  
Maintains stock records, monitors stock levels to ensure optimum stock holding. Details include stock desc., product code, unit, unit price, quantity on hand/on order/minimum. Stock analysis reports can be weekly, monthly, quarterly etc. Interfaces with Order Entry Invoicing system. Requires CBASIC-2 ..... **£325/£15**
- ORDER ENTRY & INVOICING**  
Performs order entry and invoicing function. Handles invoices for services and consumable items, part orders and part quantities. Sales Analysis report shows sales movements and trends for user-defined period. Interfaces with Stock Control, NAD and Company Sales systems. Requires CBASIC-2 ..... **£325/£15**
- NAD** — Complete control of all your names & addresses including suppliers, clients, enquiries etc. Assign your own coding system and select all output via the report generator. Will print anything from mailing labels to directories. Requires CBASIC-2 ..... **£225/£12**

EFFECTIVE 1 OCTOBER 1979

Software for most popular 8080/Z80 computer disk systems including  
**NORTH STAR HORIZON, VECTOR MZ, OHIO SCIENTIFIC,  
 CROMEMCO, PROCESSOR TECHNOLOGY, RAIR BLACK BOX,  
 DYNABYTE, SD SYSTEMS, RESEARCH MACHINES, ALTAIR,  
 EXIDY SORCERER, IMSAI, HEATH, and 8" IBM formats**

**SOFTWARE SYSTEMS**

Software with Manual / Manual Alone

- CBASIC-2** Disk Extended BASIC — Non-interactive BASIC with pseudo-code compiler and runtime interpreter. Supports full file control, chaining, integer and extended precision variables etc. **£75/£10**

**STRUCTURED SYSTEMS GROUP**

- QSORT** — Fast sort/merge program for files with fixed record length, variable field length information. Up to five ascending or descending keys. Full back-up of input files created. Parameter file created, optionally with interactive program which requires CBASIC. Parameter file may be generated with CP/M assembler utility **£50/£12**

**GRAHAM-DORIAN SOFTWARE SYSTEMS**

- APARTMENT MANAGEMENT SYSTEM** — Financial management system for receipts and security deposits of apartment projects. Captures data on vacancies, revenues, etc. for annual trend analysis. Daily report shows late rents, vacancy notices, vacancies, income lost through vacancies, etc. Requires CBASIC. Supplied in source code. **£300/£25**
- INVENTORY SYSTEM** — Captures stock levels, costs, sources, sales, ages, turnover, markup, etc. Transaction information may be entered for reporting by salesman, type of sale, date of sale, etc. Reports available both for accounting and decision making. Requires CBASIC. Supplied in source code. **£300/£25**
- CASH REGISTER** — Maintains files on daily sales. Files data by sales person and item. Tracks sales, overruns, refunds, payouts and total net deposits. Requires CBASIC. Supplied in source code **£300/£25**

**MICRO FOCUS**

- CIS COBOL** — Version 3 is ANSI 74 subset with extensions which offer powerful interactive screen formatting and built in cursor control. Version 4 additionally offers full level 1 ANSI for Nucleus, Table Handling, Sequential Relative and Indexed I/O, Inter-Program Communication and Library  
 Version 3. **£295/£25**  
 Version 4. **£395/£25**
- FORMS** — Interactive utility to create CIS COBOL source code to perform CRT screen handling in application programs. Supports full prompt text, protected fields and input validation against data type and range expected **£65/£10**  
 When purchased with CIS COBOL **£55/£10**

**OTHER**

- tiny C** — Interactive interpretive system for teaching structured programming techniques. Manual includes full source listings **£45/£30**
- C Compiler** — Supports most major features of language, including Structures, Arrays, Pointers, recursive function evaluation, linkable with library to 8080 binary output. Lacks data initialization, long & float type and static & register class specifiers. Documentation includes "C" Programming Language book by Kernighan & Ritchie **£65/£10**
- ALGOL 60 Compiler** - Powerful block-structured language featuring economical run time dynamic allocation of memory. Very compact (24K total RAM) system implementing almost all Algol 60 report features plus many powerful extensions including string handling direct disk address I/O etc. Requires Z80 CPU **£110/£12**
- Z80 Development Package** — Consists of: (1) disk file line editor, with global inter and intra-line facilities; (2) Z80 relocating assembler. Zilog/Mostek mnemonics, conditional assembly and cross reference table capabilities; (3) linking loader producing absolute Intel hex disk file for CP/M LOAD, DDT or SID facilities. **£50/£12**
- Z80 Debugger**-Trace, break and examine registers with standard Zilog/Mostek mnemonic disassembly displays. Facilities similar to DDT. £20 when ordered with Z80 Development Package. **£30/£7**

Software with Manual / Manual Alone

- DISTEL** — Disk based disassembler to Intel 8080 or TDL Xitan Z80 source code, listing and cross reference files. Intel or TDL Xitan pseudo ops optional. Runs on 8080. Standard CP/M and TRS-80 CP/M versions available **£35/£7**
- DISILOG** — TEL to Zilog/Mostek mnemonic files. Runs on Z80 only. **£35/£7**
- TEXTWRITER II** — Text formatter to justify and paginate letters and other documents. Special features include insertion of text during execution from other disk files or console, permitting recipe documents to be created from linked fragments on other files. Ideal for contracts, manuals, etc. **£45/£3**
- WHATSIT?** — Interactive data-base system using associative tags to retrieve information by subject. Hashing and random access used for fast response. Requires CBASIC **£70/£15**
- XYBASIC** Interactive Process Control BASIC — Full disk BASIC features plus unique commands to handle bytes, rotate and shift, and to test and set bits. Available in Integer, Extended and ROMable versions.  
 Integer Disk or Integer ROMable **£165/£15**  
 Extended Disk or Extended ROMable **£215/£15**
- SMAL/80** Structured Macro Assembled Language — Package of powerful general purpose text macro processor and SMAL structured language compiler. SMAL is an assembler language with IF-THEN-ELSE, LOOP-REPEAT-WHILE, DO-END, BEGIN-END constructs **£40/£10**
- Selector II** — Data Base Processor to create and maintain single Key data bases. Prints formatted, sorted reports with numerical summaries. Available for Microsoft and CBASIC (state which). Supplied in source code **£105/£12**
- Selector III** — Multi (i.e. up to 24) Key version of Selector II. Comes with applications programs including Sales Activity, Inventory, Payables, Receivables, Check Register, Expenses, Appointments, and Client/Patient. Requires CBASIC Supplied in source code **£155/£12**  
 Enhanced version for CBASIC-2 **£185/£12**
- CPM/374X Utility Package** — has full range of functions to create or re-name an IBM 3741 volume, display directory information and edit the data set contents. Provides full file transfer facilities between 3741 volume data sets and CP/M files **£125/£7**
- Flippy Disk Kit** — Template and instructions to modify single sided 5 1/4" diskettes for use of second side in singled sided drives **£6**



Orders must specify disk type and format, e.g. North Star Horizon single density.

Add VAT to orders for software (not manuals alone). Add 50p per item postage and packing (minimum £1).

All orders must be prepaid (except COD or credit card). Make cheques POs etc. payable to Lifeboat Associates.

Manual costs are deductible from subsequent software purchase.

The sale of each proprietary software package conveys a license for use on one system only.

Lifeboat Associates, 32 Neal Street, London WC2H 9PS. 01-379 7931 <sup>TM</sup>The Software Supermarket is a trademark of Lifeboat Associates

# COMPUTING BOOKS

Adams, C., Beginners Guide to Computers and Microprocessors With Projects	£ 5.70
Ahl, Basic Computer Games	£ 5.25
Albrecht, B., Basic for Home Computers	£ 4.95
Alcock, D., Illustrating Basic	£ 2.60
Altman, L., Microprocessors	£10.65
Altman, L., Applying Microprocessors	£12.00
Aspinall, D., Introduction to Microprocessors	£ 6.50
Barden, W., Z-80 Microcomputer Handbook	£ 7.75
Barden, W., How to Buy and Use Minicomputers and Microcomputers	£ 7.85
Barden, W., How to Program Microcomputers	£ 7.25
Barna, A., Introduction to Microcomputers and Microprocessors	£ 8.60
Bibbero, R., Microprocessors in Instruments and Control	£12.60
Boyce, J.C., Microprocessor and Microcomputer Basis	£11.70
Bursky, D., Microcomputer Board Data Manual	£ 6.00
Bursky, D., Microprocessor Data	£ 6.00
Bux, W., RPG and RPGII Programming	£11.80

Clifton, H., Business Data Systems	£ 6.00
Coan, J., Basic Basic	£ 7.80
Coan, J., Advanced Basic	£ 5.80
Conway, R., Intro. to Microprocessor Programming using PL/Z	£14.00
Conway, R., Intro. to Programming, Structured Approach using PL1-PLC	£14.00
Ditlea., A Simple Guide to Home Computers	£ 4.00
Duncan., Microprocessor Software Engineering	£13.60
Eadie, D., Microcomputers Theory and Operation	£13.10
Freiberger, S., Consumers Guide to Personal Computing and Microcomputers	£ 5.60
Frenzel, L., Getting Acquainted with Microprocessors	£ 7.20
Fry, T., Computer Appreciation	£ 3.95
Fry, T., Further Computer Appreciation	£ 4.95

Gilmore, C., Beginners Guide to Microprocessors	£ 4.85
Gosling, R., Beginning Basic	£ 4.75
Graham, N., Microprocessor Programming for Computer Hobbyists	£ 7.10
Grosswirth., Beginners Guide to Home Computers	£ 4.50
Hansen, P., Operating System Principles	£16.30
Hartley, Introduction to Basic	£ 2.60
Haviland, N., The Compulator Book	£6.50
Heiserman, D., Miniprocessors from Calculators to Computers	£ 5.00
Higgins D., Programmed Design and Construction	£ 7.50
Hilburn, J., Microcomputers Microprocessors Hardware/Software Application	£17.00
Hill, F., Digital Systems Hardware Organisation and Design	£ 9.00
Huffman, J., Microprocessors in Personal Computing	£11.10
Hunt, R., Computers and Commonsense	£ 4.00
Johnson, D., Digital Circuits and Microcomputers	£13.10
Jung, W., IC OP AMP Cookbook	£10.00
Jung, W., IC Converter Cookbook	£ 9.50
Jung, W., IC Timer Cookbook	£ 7.50
Klingman, E., Microprocessor Systems Design	£17.00
Kemeny, J., Basic Programming	£ 6.50
Korn, G., Microprocessor and Small Digital Computer Systems for Engineers and Scientists	£19.00
Kraus, L., Computer Fraud and Counter Measures	£21.50

Lenk, J., Handbook of Practical Microcomputer Troubleshooting	£13.00
Lesea, A., Microprocessor Interfacing Techniques	£ 8.00
Leventhal, Introduction to Microprocessors	£16.70
Lewis, T.G., Mind Appliance Home Computer Applications	£ 5.00
Libes, S., Small Computer Systems Handbook	£ 6.00
Lippiatt, Architecture of Small Computer Systems	£ 4.60
Mano, M., Digital Logic and Computer Design	£18.30
Munro., Interactive Computing with Basic	£ 3.65
Munro., Basic Basic	£ 2.50
Moody, R., First Book of Microcomputers	£ 4.00
McGlynn, D., Microprocessors Technology Architecture & Applications	£ 8.60
McMurrin, Programming Microprocessors	£ 5.75
Myers, S., RPG II with Business Applications	£14.00

Nagin, P., Basic with Style	£ 4.25
Nahigian., Computer Games for Business Schools and Home	£10.50
Ogdin., Software Design for Microcomputers	£ 7.00
Ogdin., Microcomputer Design	£ 7.00
Peatman, J., Microcomputer Based Design	£ 7.00
Peatman, J., Design of Digital Systems	£ 7.90
Peckham, Hands on Basic with a Pet	£ 8.70
Peckham, Basic A Hands On Method	£ 6.95
Rosen, A., Word Processing	£11.60
Rao, G., Microprocessor and Microprocessor Systems	£20.50
Rony, P., 8080A Bugbook Micromputer Interfacing and Programming	£ 8.20

Please note that all prices include postage and packing. Please make cheques, etc. payable to Technical Book Services (payment in U.K. currency only please).



Lancaster, D., TV Typewriter Cookbook	£ 7.75
Lancaster, D., Cheap Video Cookbook	£ 6.50
Lancaster, D., TTL Cookbook	£ 7.00
Lancaster, D., CMOS Cookbook	£ 8.20
Lancaster, D., Incredible Secret Money Machine (How to set up your computer or technical business)	£ 4.95
Lenk, J., Handbook of Microprocessors Microcomputers and Mini-computers	£14.00

## What is a microprocessor?

If you are considering buying a Microcomputer, Development System, or just want to learn more about this exciting technology, then this short introduction to Microprocessors is for you. Comprising of a 72-page book keyed to over two hours of cassette tapes the many aspects of Microprocessors are explained, including Binary and Hexadecimal counting. Internal structure. Operation. Programming Techniques. Devising a program, etc. Learn at your own pace with this valuable addition to your reference library. £10.75

Scelbi., 6800 Software Gourmet Guide and Cookbook	£ 7.80
Scelbi., 8080 Software Gourmet Guide and Cookbook	£ 7.80
Scelbi., Understanding Microcomputers	£ 8.80
Schoman, K., The Basic Workbook	£ 4.00
Sipple, L., Computer Power for Small Business	£ 7.50
Sirion, D., Basic from the Ground Up	£ 6.25
Snover, How to Program Your Programmable Calculator	£ 6.00
Sourceck, B., Microprocessors and Microcomputers	£19.00

Spencer, Game Playing with Basic	£ 5.00
Spencer., Computers in Society	£ 4.00
Spracklen., Sargon (Computer chess program in Z-80)	£10.00
Streitmatter, G., Microprocessors Theory and Application	£12.50
Titus, C., 8080/8085 Software Design	£ 7.60
Titus, C., Microcomputer Analog Converter Software and Hardware Interfacing	£ 7.60
Tocci, R., Microcomputers and Microprocessors Hardware/Software	£11.80
Tracton, K., Basic Cookbook	£ 4.50
Tracton, K., 57 Practical Programs and Games in Basic	£ 6.60
Veronis., Microprocessor Design and Applications	£13.00

Waite, M., Microcomputer Primer	£ 6.50
Waite, M., Your Own Computer	£ 1.50
Welsh, J., Introduction to Pascal	£ 7.60
Wirth, N., Algorithms Plus Data Structure = Programs	£16.30
Ward, Microprocessor/Microprogramming Handbook	£ 6.20
Yourdin., Structured Design	£16.30
Zaks, R., Introduction to Personal and Business Computing	£ 8.50
Zaks, R., Microprocessors from Chips to Systems	£ 8.50
Zaks, R., Programming the 6502	£ 8.60
Zaks, R., 6502 Applications Books	£ 8.60
Zelkowitz, M., Principles of Software Engineering	£15.00

**SEND TO:**  
**TECHNICAL BOOK**  
**SERVICES,**  
**PC11 PO BOX 79,**  
**MAIDENHEAD,**  
**BERKSHIRE SL6 2EG**  
**A division of Strathearn**  
**Publishing Ltd.**

## Semiconductor Guides.

### THT '77

Data and comparison table for thyristors, tetrodes, trigger diodes, triacs, unijunction transistors (JTs) and programmable UJTs (PUTs) 250,000 entries. Order No. 20.

### IC-lin 1

Data and comparison table for integrated op amps and comparators. 2nd edition, DIN A6 compact format. 288 pages, types, functions, applicational examples, 152 connection drawings, 48 case drawings. Order No. 11

### TVT '78 Vol. 1: A...Z

Transistor comparison table. Lists more than 25,000 equivalent types for approx. 5,000 transistors. 9th edition. 292 pages, 11 illustrations, 137 connection drawings. In handy compact format DIN A6, wipe-clean cover. Order No. 30 ISBN 3-88109-010-X

### ALSO AVAILABLE

Diode Equivalent Book	£ 2.30	Digital I.C. Equivalent Book	£ 5.50
Diode Data Book	£ 2.30	TVT '78 Vol. 2: 2N... <sup>∞</sup>	

Transistor comparison table. Lists more than 35,000 equivalent types for approx. 7,000 transistors.

2N ...—2SA ...	2SD ...—2SK ...
2SB ...—2SC ...	3N ...— <sup>∞</sup>

408 pages, 11 illustrations, 141 connection drawings. In handy compact format DIN A6, wipe-clean cover. Order No. 31 ISBN 3-88109-011-8.

TVT78 A-Z	£ 4.00	LIN 1	£ 3.60
TVT 782N	£ 4.00	LIN 2	£ 3.80
THT77	£ 4.00		

# aculab Ltd

> ACULAB 735, a fully self-contained interface for IBM 735 output golfball typewriters.



- > Parallel model accepts 7-bit ASCII data via Centronics compatible connector.
- > Serial model accepts RS232/V24, Baud rate selectable. (Parallel model may be retro-fitted with serial board).
- > Programmed for 7 different typehead layouts, covers all common golfballs and an ASCII ball, switch selectable.
- > Stop/Go switch, Online/Offline switch, also Online/Offline under software control.
- > Parallel ..... £155-00 + VAT
- > Serial ..... £205-00 + VAT

**aculab** Ltd.

24 Heath Road,  
Leighton Buzzard, Beds.  
LU7 8AB

For further information  
Telephone. 0525-371393.

• Circle No. 106

**MICRO COMPUTER CENTRE,**  
314 Upper Richmond Road West,  
East Sheen, S.W.14 876 6609.

Business Specialists/Authorised Dealers for

## PET

### Computers

- Standard PET with integral cassette and calculator type keyboard. 8K bytes of memory £550.00
- PET with 16K bytes of memory and large keyboard. External cassette optional £695.00
- PET with 32K bytes of memory and large keyboard. External cassette optional £795.00

### Printers

- Whymark 201 - 20 columns complete with interface £400.00
- Datac BD80 - 80 columns £750.00
- 1-way Interface £106.00
- Teletype 43 - 132 columns - Upper and Lower Case Keyboard £900.00
- 2-way Interface £186.00

### Memories

- 16K Memory Extension for 2001 - 8K £276.00
- 24K Memory Extension for 2001 - 8K £337.00

### Disc Drives

- Compu/Think Twin Floppy Disc Drive - double sided discs - 100K per side £833.00
- Pet Twin Floppy Disc Dual Drive including cable £815.00
- Cassette Recorder £55.00

The above prices are exclusive of VAT. All the above items are IN STOCK at time of going to press.

We stock all PET accessories and handbooks PETSOF and PETACT Programs.

• Circle No. 107

# Programs for easy learning.

Part of the Heathkit Continuing Education series, our self-instruction courses are the complete, low cost way of learning all there is to know about computing techniques.

Each course is split into progres-

sive sections and contains audio visual material, text, and parts for practical experiments.

### Digital techniques

Teaches you the operation of digital logic circuits, integrated circuits,

Boolean Algebra, Flip-Flops and Registers. Everything from TTL and CMOS to ROMs, PLAs, microprocessors and computers.

The optional trainer rounds out your education and provides 'hands-on' experience.

### Microprocessor

Designed to give you in-depth knowledge of these advanced systems the course covers microprocessor basics, computer arithmetic, programming and much, much more.

And the optional computer trainer lets you get 'hands-on' experience.

### Basic Programming

This course teaches you how to program your computer using the popular BASIC language. Covering all formats, commands, statements and procedures, it uses programmed instructions backed by text and 'hands-on' computer experiments.

For full details of these and all Heath courses contact:  
Heath (Gloucester) Limited,  
Dept. (PCE 10), Bristol Road, Gloucester,  
GL2 6EE. Tel: (0452) 29451.



## Heath data systems

• Circle No. 108

# ALMARC NO.1 FOR VECTOR GRAPHIC

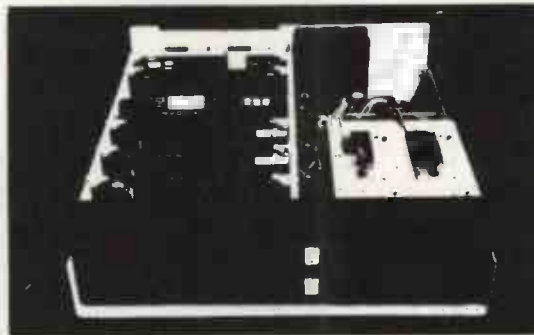
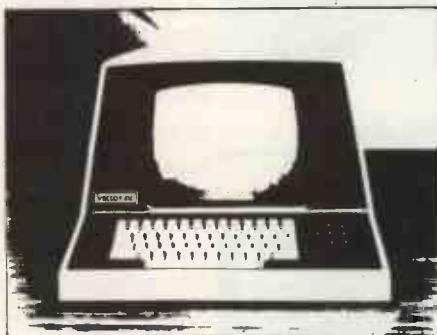

## OUR NEW EXTENDED RANGE OF PROFESSIONAL GRADE SYSTEMS

### SYSTEM MZ

Z80 4MHZ CPU, 48K Ram, 630K bytes disc storage, Serial port & two parallel ports, prom rad board with monitor, 18 slot motherboard (S100), MDOS operating system, Z80 assembler, Basic interpreter

£2300.00

### SYSTEM B

As MZ plus Vector mindless terminal, 24x80 flashwriter board, MZOS North Star compatible DOS. CP/M configured by Almarc:

£2850.00

### SYSTEM BG

As System B plus 240x256 graphics board, 8K memory, 10" monitor.

£3240.00

### SYSTEM BF

As System B plus Fast Fortran 80 compiler with hardwired floating point system which includes board and interface software for Fortran. This system uses the A.M.D. chip and provides breathtakingly fast floating point manipulation

£3595.00

### SYSTEM BFG

Combines BG & BF plus 'Glib' graphics package for use with Fast Fortran 80 and 240x256 graphics board

£4190.00

We also sell a wide range of s100 boards and C/PM compatible software.

### WE ARE THE SPECIALISTS

When you spend £2000.00+ on a microcomputer system you're entitled to support from people who understand the equipment and your problems. At ALMARC we don't sell systems from many different manufacturers, we specialise in Vector Graphic systems and supporting hardware & software. So if you want to just buy different makes of hardware then don't come to us, but when you decide that Vector Graphic is for you then contact ALMARC.

## ALMARC

ALMARC DATA SYSTEMS LTD., 29 CHESTERFIELD DRIVE,  
BURTON JOYCE, NOTTINGHAM. Telephone: 0602 248565

• Circle No. 109

## 24 TUNE DOOR CHIMES

### DOOR TUNES £16.44 + VAT.

Waddington's Videomaster announce a doorbell that doesn't go Brrrrrrrrg, Ding Dong or Bzzzzz. Instead it plays 24 different classical and popular tunes. It will play the tune you select for your mood, the season or the visitor you are expecting to call. Door tunes is not only great fun and a wonderful ice breaker, but is also very functionally and beautifully designed to enhance your home. There is something for Christmas, something for your continental visitors or your relations from the states, and even something for the Queen. Door tunes is easy to install and has separate controls for volume, tone and tempo.



## T.V. GAMES

### PROGRAMMABLE £29.50 + VAT. COLOUR CARTRIDGE T.V. GAME.

The TV game can be compared to an audio cassette deck and is programmed to play a multitude of different games in COLOUR, using various plug-in cartridges. At long last a TV game is available which will keep pace with improving technology by allowing you to extend your library of games with the purchase of additional cartridges as new games are developed. Each cartridge contains up to ten different action games and the first cartridge containing ten sports games is included free with the console. Other cartridges are currently available to enable you to play such games as Grand Prix Motor Racing, Super Wipeout and Stunt Rider. Further cartridges are to be released later this year, including Tank Battle, Hunt the Sub and Target. The console comes complete with two removable joystick player controls to enable you to move in all four directions (up/down/right/left) and built into these joysticks controls are ball serve and target fire buttons. Other features include several difficulty option switches, automatic on screen digital scoring and colour coding on scores and balls. Lifelike sounds are transmitted through the TV's speaker, simulating the actual game being played. Manufactured by Waddington's Videomaster and guaranteed for one year.



#### EXTRA CARTRIDGES

#### ROAD RACE - £8.87 + VAT.

Grand Prix motor racing with gear changes, crash noises.

#### SUPER WIPEOUT - £9.17 + VAT.

10 different games of blasting obstacles off the screen.

#### STUNT RIDER - £12.16 + VAT.

Motorcycle speed trials, jumping obstacles, leaping various rows of up to 24 buses etc.

#### NON PROGRAMMABLE TV GAMES

6 Game - COLOURSCORE II - £13.50 + VAT.

10 Game COLOUR SPORTSWORLD £22.50 + VAT.

## CHESS COMPUTERS

### STAR CHESS - £56.09 + VAT. PLAY CHESS AGAINST YOUR PARTNER.

using your own TV to display the board and pieces. Star Chess is a new absorbing game for two players, which will interest and excite all ages. The unit plugs into the aerial socket of your TV set and displays the board and pieces in full colour for black and white on your TV screen. Based on the moves of chess it adds even more excitement and interest to the game. For those who have never played, Star Chess is a novel introduction to the classic game of chess. For the experienced chess player, there are whole new dimensions of unpredictability and chance added to the strategy of the game. Not only can pieces be taken in conventional chess type moves, but each piece can also exchange rocket fire with its opponents. The unit comes complete with a free 18V mains adaptor, full instructions and twelve months guarantee.



### CHESS CHALLENGER £98.50 PLAY CHESS AGAINST THE COMPUTER.

The stylish, compact, portable console can be set to play at seven different levels of ability from beginner to expert including "Mate in two" and "Chess by mail". The computer will only make responses which obey international chess rules. Casting, on passant, and promoting a pawn are all included as part of the computer's programme. It is possible to enter any given problem from magazines or newspapers or alternatively establish your own board position and watch the computer react. The positions of all pieces can be verified by using the computer memory recall button.

Price includes unit with wood grained housing, and Staunton design chess pieces. Computer plays black or white and against itself and comes complete with a mains adaptor and 12 months guarantee.

#### OTHER CHESS COMPUTERS IN OUR RANGE INCLUDE

CHESS CHAMPION - 6 LEVELS £48.26 + VAT

CHESS CHALLENGER - 10 LEVELS - £143.06

+ VAT.

BORIS - MULTILEVEL TALKING DISPLAY £165.28

+ VAT.



#### ELECTRONIC CHESS BOARD TUTOR £19.75 inc. VAT.

A special bulk purchase of these amazing chess teaching machines enables us to offer them at only £19.75 less than half recommended retail price. The electronic chess tutor is a simple battery operated machine that can actually teach anyone to play chess and improve their game right up to championship level. This machine is not only for total beginners but also for established players wanting to play better chess. Unit contains the electronic chessboard with 32 chess pieces, a 64 page explanatory booklet and a set of 32 progressive programme cards including 6 beginners cards, 16 check mate positions, 9 miniature games, 5 openings, 3 end games, 28 chess problems and 2 master games.

## DRAUGHTS COMPUTERS

### CHECKER CHALLENGER 2 LEVELS £43.00+ VAT. 4 LEVELS £78.50+ VAT.

The draughts computer enables you to sharpen your skills, improve your game, and play whenever you want. The computer incorporates a sophisticated, reliable, decision making microprocessor as its brain. Its high level of thinking ability enables it to respond with its best counter moves like a skilled human opponent. You can select offence or defence and change playing difficulty levels at any time. Positions can be verified by computer memory recall. Machine does not permit illegal moves and can solve set problems. Computer comes complete with instructions, mains adaptor and twelve months guarantee.

#### PLAY DRAUGHTS/CHECKERS AGAINST THE COMPUTER

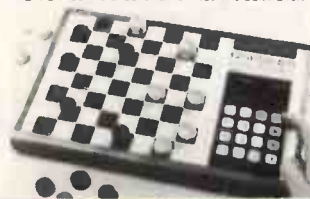

## FOR FREE BROCHURES - SEND S.A.E

For FREE illustrated brochures and reviews on TV and chess games please send a stamped addressed envelope, and state which particular games you require information on.

Callers welcome at our shop in Welling - demonstrations daily - open from 9am-5.30pm Mon-Sat 10am-1pm Wed-Thu. Order by telephone please quote your name, address and Access/Barclaycard number.

Postage and Packing FREE

AJD DIRECT SUPPLIES LIMITED, Dept. P.C.11 102 Bellegrave Road,  
Welling Kent DA16 3DD. Tel: 01-303 9145 (Day) 01-850 8652 (Evenings)

# G.P.W. Electronics

## GPW System 10

Tandy TRS-80 Business System. Requires Level 2 32K computer, at least 2 mini floppy disk drives and one line printer. Uses the superb TRIDATA software for stock control, payroll and multiple ledger.

Price from £2,500 for hardware.

## GPW System 30



Based on the 32K Exidy Sorcerer computer, micropolis duel drive double density disk system, and high resolution monitor. Choice of printers, word processing available. Stock control and multiple ledger available now.

Price from £3,000 for hardware.

## GPW System 50



Compucorp 600 series computer featuring minimum 40K on board, single 160K disk 80 x 20 CRT and S10 with Texas Instrument 810 printer.

Software available now includes multiple ledger, insurance, window design, engineering spares, and mail shot.

Price from £6,000 for Hardware.

## GPW System 70

Gamma Poseidon DEC LSI-11 system. Features multi-user, multi-task, high capacity fast access storage, OKI printer and Hazeltine visual display terminal. Masses of software including RT11, NET11, DIBOL, FORTRAN, BASIC, and APL. Minimum 64K LSI-11, 10 meg disk subsystem, 180 ch/sec printer and VDU.

Price from £12,100 for hardware.

## WE GIVE FIELD SERVICE ON ALL OUR COMPUTERS

### S100 Kit systems

We supply 8080A and Z-80 based S100 systems with full documentation. If you want to build your own computer we can help and advise. GPW S100 expansion box includes Motherboard, PSU and cooling fan. Price £145 + VAT.

### Books

Stock includes the highly recommended Adam Osbourne and Rodney Zacs series.

### Components

6504 CMOS £15; 2114 (450 STATIC) £4.50; Z-80 CPU £9.00; 5101 (450 CMOS) £4.50; TMS 4003 MOS £1.50; 2708 £7.40.

We can supply most micros, Prices include Post and Packing. Please add VAT CWO Access or Barclaycard.

# If your Accounts are a problem- the solution could be on your desk.

You could use your telephone to call Comma Computers on Brentwood (0277) 811131.

Or you could use a pen and envelope to complete and return the coupon to us.

Later on, you could have a free copy of our 'no jargon' brochure on your desk from which you could see how Comma Computers have used advanced micro-processor technology to make business computers easy to understand, use and afford!

Still later, but not much later because Comma Computers are quick and simple to install, you

could have a Comma Aquarius, Aries or Leo business system on your desk – a complete system with computer, printer, keyboard, display, installation, 12 months maintenance and software to perform Payroll, Accounts, Invoicing and Credit Control applications and provide instant management information including Profit and Loss Statements and all from less than £6000.

Butchers, bakers, candlestick makers . . . can all, at last, enjoy the benefits brought to business by the silicon chip and increase the efficiency of dealings with customers and suppliers as well as accountants, auditors, HM Collectors of Taxes and Customs and Excise.

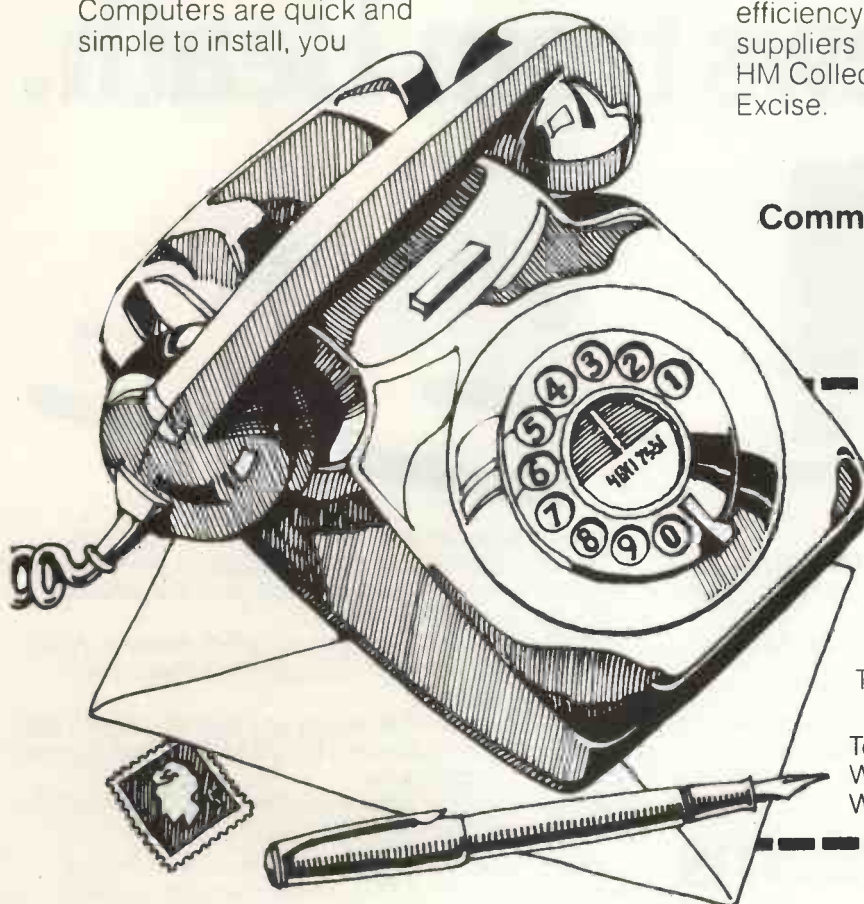

## Comma Computers Ltd.

West Horndon  
Industrial Park,  
West Horndon,  
Essex CM13 3XJ



Name \_\_\_\_\_  
Position \_\_\_\_\_  
Organisation \_\_\_\_\_  
Address \_\_\_\_\_  
Postcode \_\_\_\_\_  
Telephone \_\_\_\_\_

To: Comma Computers Ltd,  
West Horndon Industrial Park,  
West Horndon, Essex CM13 3XJ

• Circle No. 112

# OHIO SCIENTIFIC from the UK's specialist importers

A complete  
**minidisc system**  
 for less than  
**£1000**



Discs allow fast, even automatic, program loading and running plus use of data files under program control. So really a single disc system has 100k on-line for programs and data — and exchange of disks makes even more data readily available. Once you've used a disk you'll never be satisfied with a cassette again! An 8K program will load in less than a second. However the CIP range starts with a 4K RAM, 8K BASIC-in-ROM system, fully expandable to disc later, for only £290.00 (needs TV and audio cassette). All TV and video output modified for 50 Hz giving steady display.

- 6502  $\mu$ p, ultra fast floating point 9 digit BASIC. Full disc operating system with random access and named files
- TV or monitor output, QWERTY keyboard, upper/lower case, graphics.
- Expandable to 32K, dual discs, printers etc.
  - C1P 4K, 8K BASIC-in-ROM £ 290.00
  - C1PSF, single floppy, 20K, OS65D £ 980.00
  - C1PDF, dual floppies, 20K, OS65D £1418.00
  - OSI recommended monitor £ 99.00

VAT and delivery in addition. Over 60 programs available on mini disc or cassette. Mini data base management package!  
 SUPERBOARD II software and expansion accessories available.

We are also —

 **Apple II** dealer.

 **Verbatim** magnetic media stockist.

 **Seattle Computer Products, Inc.** importers.



- Suppliers of printers, VDU's etc.
- Small business systems consultants.
- Available for custom software production.

## U-MICROCOMPUTERS

**U-Microcomputers Ltd**

2 Station Road, Weaverham, Nr Northwich, Cheshire.

Tel: 0606-853390 Telex: 666592

• Circle No. 113

# Great news from Heath.

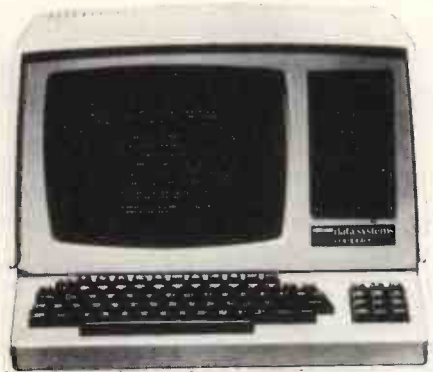

### WH-89 All-In-One computer.

The new All-In-One computer from Heath has the power, versatility, and built-in peripherals needed to meet the demands of the business user.

- \*'intelligent' video terminal \*2Z80 microprocessors.
- \*floppy disk storage system.
- \*basic 16K RAM (expandable).

Easy to program. Simple to operate. It is capable of a multitude of high-speed functions and speaks the language of today's most popular software.

## Heath data systems

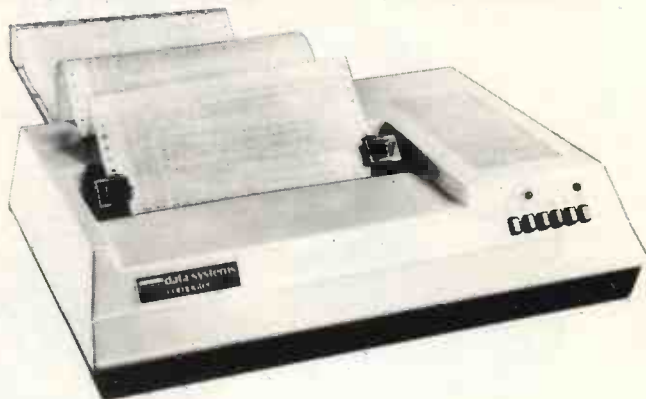

### WH-14 serial printer.

With a compact table-top configuration, the WH-14 is designed for a broad variety of uses in both the personal and business computing field.

- \*5 x 7 dot matrix impact printing \*96 character ASCII
- \*upper and lower case characters \*microprocessor-based electronics.

It combines speed, flexibility and ease of use with any computer providing standard RS-232 C or 20mA current loop interface connections.

For complete specifications of these and all Heath Data System products contact:

Heath (Gloucester) Limited, Dept. (PCH 10), Bristol Road, Gloucester, GL2 6EE. Telephone: (0452) 29451.

• Circle No. 114

# Train your PET in accounting systems

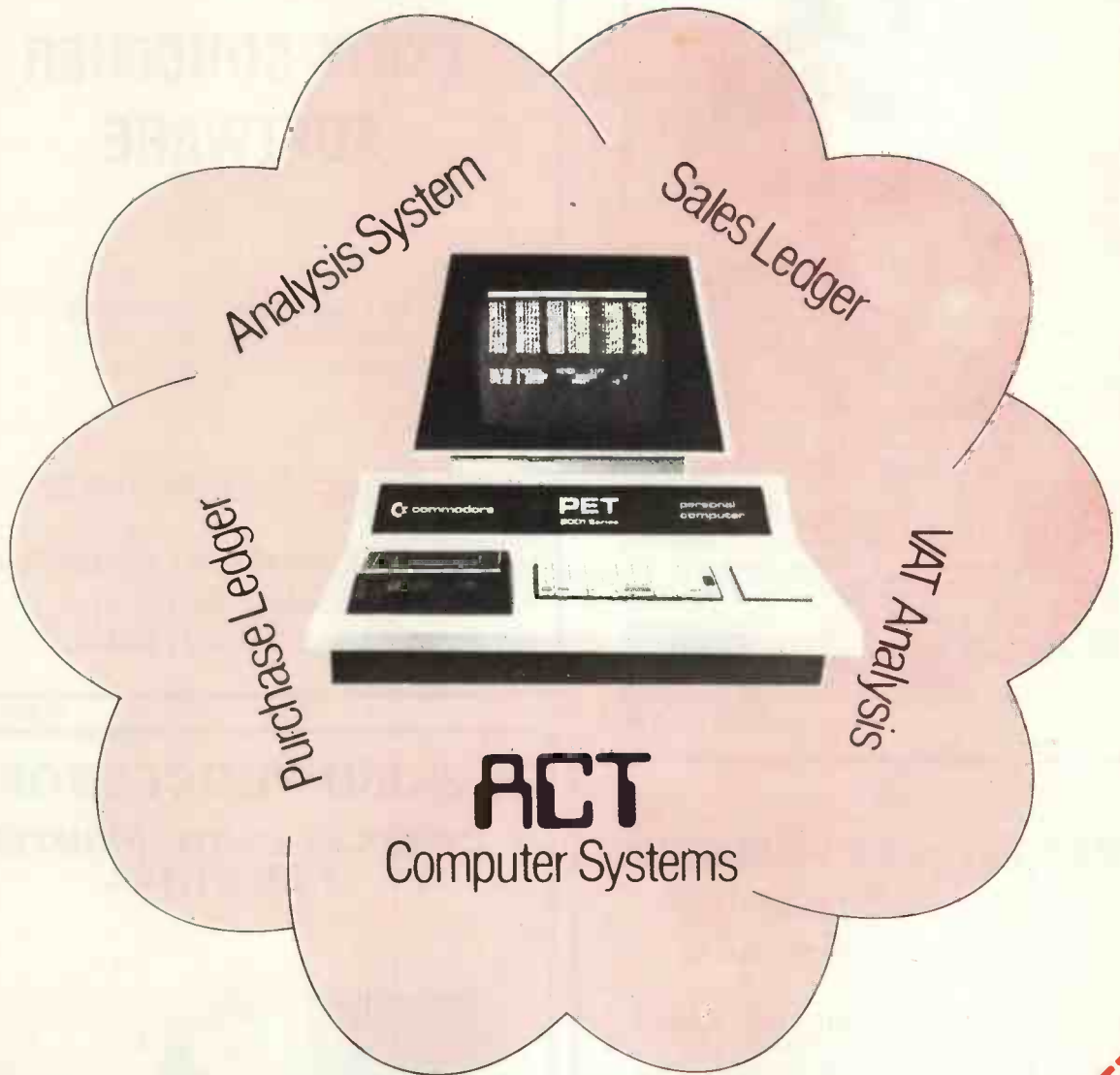

**PETAL...** is ACT's way of putting Analysis and Ledgers on your 8K Commodore PET.

**Sales Ledger**  
with complete Statement/Remittance Advice, Debtors Control List and Overdue Letters.

**Purchase Ledger**  
with complete P.L. Record/Remittance Advice, Creditors Control List and Credit Transfers

**Analysis**  
a powerful analysis system allowing full management reporting.

**VAT Analysis**  
a purpose built analysis to take away the VAT blues.

**PETAL...** combines all the advantages of your own Commodore PET together with a low cost Bureau Service.

**PETAL...** is available from:-

Applied Computer Techniques Limited  
Graphic House  
Telephone Avenue  
Bristol BS1 4BS.  
Telephone 0272 211733

**ACT**

I am interested in knowing more about PETAL. Please send me a free copy of your Systems Manual. Also available from your Commodore PET dealer.

NAME \_\_\_\_\_  
COMPANY \_\_\_\_\_  
ADDRESS \_\_\_\_\_  
TEL \_\_\_\_\_

PC1

• Circle No. 115

BUILD THE

12,000 ALREADY SOLD



**NASCOM I  
COMPUTER**

★ British Design ★ UK Best Selling Kits  
★ FULL AFTER SALES SERVICE & GUARANTEE

KITS IN STOCKS

We are the Sole Approved London Stockist and National Distributor

FREE MODULATOR and B-BUG

**FEATURES**

- ★ Supplied in kit form for self-assembly
- ★ Full documentation supplied
- ★ Fully screened double-sided plated through hole printed circuit board
- ★ Full 48 key keyboard included
- ★ 2K x 8 Ram
- ★ 1K x 8 monitor program in Eprom
- ★ Powerful Mostek Z80 CPU
- ★ 16 x 48 character display interface to std un-modified T.V.
- ★ T.V. display memory mapped for high speed access
- ★ On board expansion to 2K x 8 Eprom



£165.00 - VAT  
POST FREE

- ★ On board expansion for additional 16 I/O lines
- ★ Memory may be expanded to full 60K

**EXPANSION**

- ★ Expansion buffer board £32.50

MEMORY KITS (inclusive all hardware)

- 8K ..... £85
- 16K ..... £140
- 32K ..... £200

★ I/O board with decoders and all hardware except ICS will accept up to 3 PIOs, 1 CTV and 1 UART ..... £35

**OTHER HARDWARE**

- ★ 3A power supply for up to 32K expansion ..... £19.90
- ★ 3A power supply for up to 32K expansion Mk II ..... £24.50
- ★ 8A power supply for larger than 32K expansion ..... £60.00
- ★ Expansion card frame ..... £29.50
- ★ E PROM programmer ..... £40.00
- ★ E PROM Eraser ..... £25.00
- ★ Keyboard cabinet ..... £3.50
- ★ Programming manual ..... £4.00

**SOFTWARE**

- ★ 1K x 8 monitor program providing
- ★ 8 operating commands, supporting Mem examine/modify, tabulate, copy, break, single step execute tape, load, tape dump
- ★ Reflective monitor addressing for flexible monitor expansion through user programs
- ★ Monitor sub-routines include—delay ASCII coding, binary to hex convert/pn, clr screen, scroll up, string print, cursor shift and many others

NEW T-4 operating system in (2) 2708 EPROMS upwards compatible from T2 and B-BUG ..... £25.00

- Tiny Basic ..... £25.00
- Super Tiny Basic (with editor and machine utility routines) ..... £35.00
- Zeap assembler editor ..... £32.00

★ VAT 8% ALL ITEMS EXCEPT BOOKS ★ DEMONSTRATIONS CONTINUOUS DAILY ★ WE WELCOME EXPORT—EDUCATIONAL AND INDUSTRIAL ENQUIRIES ★ FREE BROCHURE—SEND SAE 9½ x 6½ STAMP 12p.



**Henry's**  
Phone (01) 723 1008

All mail to:  
Henry's Radio  
404 Edgware Rd  
London W2



• Circle No. 116

**MICRO 44 . . .**

Announces their New Range of

**EXIDY SORCERER  
SOFTWARE**

Also customised programming and software consultancy and support on all micros.

Contact Andy Marshall at:

MICRO 44, 44 Arthurs Bridge Road,  
Woking, Surrey or  
Phone: (04862) 66084.

• Circle No. 118

**OPENING SEPTEMBER  
HOME + BUSINESS COMPUTERS**

“PET SHOP” FOR THE HOME AND SMALL BUSINESS MAN 8K—16K—32K

“THE QUICKNESS OF THE CHIP DECEIVES THE EYE” WITH SORCERER 32K OF MAGIC. THE IDEAL SYSTEM FOR THE MORE AMBITIOUS HOME USER AND THE BUSINESS MAN FLOPPY DISKS PRINTERS-WORD PROCESSING

BOOKS, MAGS, TAPES GALORE!

Add a little colour to your life with APPLE/ITT 2020 what better use for your colour TV?

WE ARE HERE

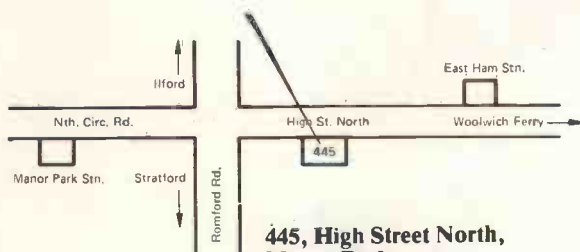

**445, High Street North,  
Manor Park,  
LONDON E.12.  
Tel: 01-472 5017 (24hr Ansaphone)**

• Circle No. 117

**WORD PROCESSOR  
COMPLETE WITH PRINTER  
FOR £1,195**



Based on TRS-80 Level II, 12in. wide screen, 64 characters (A4) wide, upper/lower-case, superb Electric Pencil software, Anadex 8000 dot matrix printer or Qume daisywheel printer (option).

General business software also available to run on the above system.

- Complete with Anadex printer 16K ..... £1,195
- As above 48K & 2 disc drives ..... £1,995
- Qume daisy printer in lieu Anadex ..... £995
- Dual floppy disc drives ..... £575

All prices ex. VAT.

Phone/write for further details or demonstration.

**LONDON COMPUTER STORE  
43, GRAFTON WAY, LONDON W1.  
Tel. 01-388 5721.**

• Circle No. 119



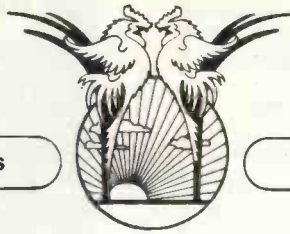

## Quality Performance Value and Delivery Delta Offers them all

Terodec are the sole U.K. Distributor for Delta Products. Delta are the Californian Manufacturer of S-100 and S-44 (Delta's own bus for Industrial Control) microcomputers.

A newcomer to Britain, Delta has an established record in the States for delivering a wide range of quality products and providing solutions other manufacturers cannot. Systems with Flexibility and capacity at sensible prices. Delta has a continuing policy of Technical innovation, the latest is a reliable double-density disc controller using latest LSI technology.

Terodec offers Delta's wide range of products: CPUS, Static Memory, Disc Controllers, Terminal Simulator, Serial and parallel interfaces, tape controllers and many more. All products are designed to operate with CPM so a wide range of applications software can be used.

- Professional Word Processing System: 64K RAM, 2Mbytes of Disc Storage, Diablo 1650, High-Quality VDU, CPM 1.4 Wordstar, Z-80 CPU, Attractively-styled Work Station ..... £6,218
- Systems:
  - 64K RAM, 4MHz Z-80 CPU, 2 serial and 3 parallel ports, 1M bytes of Disc Storage High-Quality VDU CPM 1.4 ..... £2,815
  - 64K RAM, 4MHz Z-80 CPU, 2 serial and 3 parallel ports, 2M bytes of Disc Storage High-Quality VDU 150 cps 132 character printer ..... £4,560
- S-100 Boards and Mainframe:
  - DP-CPU 4MHz Z-80 2 serial and 3 parallel Ports Monitor.... £184
  - DP-DSK Double-Density Disk Controller ..... £218
  - S-100 Mainframe 12 Slot Mth/B PSU and Cabinet ..... £225
- 32K Static RAM with Bank Select ..... £427
- Disc Drives with PSU and Cabinet:
  - DP 1000K 1Mbyte of Disc Storage ..... £956
  - DP 2000K 2Mbyte of Disc Storage ..... £1,209
  - DP 4000K 4Mbyte of Disc Storage ..... £1,953
- S-44 Industrial Control System Designed for Rugged Environments:
  - DP-Z-80A 4MHz Z-80 CPU 2 Parallel Ports Monitor
  - DP-DSK 2A Double-Density Disc Controller..... £255
  - DP-16KA 16K Static RAM ..... £230
  - DP-FPA Front Panel Traps Trace and more ..... £55
  - DP-MTH 15 15 Slot Mth/B Kit ..... £51
  - DP-PWRA Power Supply for S-44 Kit ..... £58.30
  - DP-CHSA S-44 Card Cage Kit ..... £30
- All boards and Systems are supplied assembled and tested.

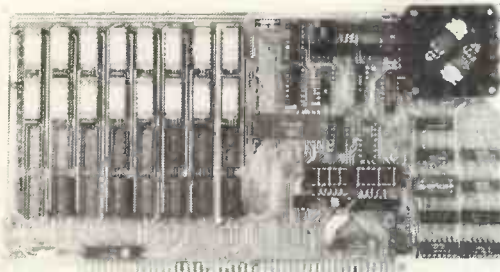

Central Data

### New RAM Prices. From The Dynamic Memory Company.

- Deselectable in 2K increments — the deselect allows 2K areas of memory to be switched off to avoid memory overlap • Z-80 and 8080 compatible at both 2MHz and 4MHz • Fully-socketed — allows the user to expand the board • Power saving Dynamic RAM with invisible refresh • Plus selectable addressing • S-100 compatible • Reliable — one year guarantee.

16K — £150      32K — £220  
48K — £290      64K — £360

4MHz Boards at £5/16K additional

### SOFTWARE

#### OSBORNE & ASSOCIATES

- CBASIC-2 Version. Runs either on CP/M or CDOS 1.07
- Accounts Payable & Accounts Receivable ..... £80
- General Ledger ..... £80
- Payroll with Cost Accounting ..... £80

#### MICROPRO

- WORD-STAR — Menu-driven visual word-processing system for use with standard terminals. Text formatting performed on screen. Facilities for text paginate, page number, justify, centre underline and PRINT. The most complete, totally-integrated, word-processing system software you've ever seen on a micro-computer. .... £255

We also supply CP/M C BASIC-2, Inventory Control UCSD PASCAL COBOL FORTRAN and DATABASE

TERODEC supply a full range of hardware and software that represent the best in quality, price and delivery. Our product range includes the CROMEMCO CS-2 and CS-3, printers from DECISION DATA, VDUs from TVI and SOROC and MICROMATION's Double-Density Disc Controller, Z-Plus and Megabox-1.

We can arrange on-site maintenance on all the above equipment.

All prices are correct at the time of going to press and do not include delivery or VAT. Office hours 9-6 Mon-Sat. Please phone for appointment. 24 hour answering service.

OEM & Dealer Enquiries Invited.

# Happy Memories

21L02	450ns	83p	TRS-80 16K Upgrade Kit
21L02	250ns	100p	
2114	450ns	525p	£69 for keyboard unit
2114	250ns	575p	
4116	300ns	790p	£63-50 for expansion box
4116	150ns	840p	
2708	450ns	750p	

Floppy Discs by VERBATIM £27-50 box of 10  
(Mini soft sectored for APPLE, PET, TRS-80 etc.)

We stock the full NASCOM range of products

Large quantity of 74LS stocked along with many other components. free lists sent upon request

TEXAS IC SOCKETS	8	14	16	18	20	22	24	28	40
Solder tail	pence: 10 11 12 16 17 19 21 27 37								
Wire wrap	- - 24 36 39 46 58 61 63 70 109								

Gold plated S100 edge connectors £3-25 each 3/£9-50

4, 7 & 8 way DIP switches, all at 85p We keep a full range of wire wrapping equipment: Wrap-Strip-Unwrap tool £5-97

50 foot reel of wire £1-64 Just-Wrap tool with 50' wire £12-21



We've got Euroconnectors  
Educational & Government  
orders welcome Min £10



Shop open ten until six Access & Barclaycard  
Prices inc VAT, orders below £10 add 25p p & p

**19 Bevois Valley Road, Southampton,  
Hants. SO2 0JP Tel: (0703) 39267**

• Circle No. 121

**GODBOUT Computer Products**

Alpha Micro/Altair/Cromemco/Imesai/North Star/Polymorphic, etc. S-100 Bus computer compatible memory and other products.

SOME PRODUCTS FROM OUR CATALOGUE e.g. --

Econoram 2708, 16K EPROM# (No EPROMS).	Kit	Ass
2708 EPROM I.C. 625 na	£45	£65
2716 EPROM I.C. POA na		
Econoram 11a 4MHz, 8K Bytes	£80	£99
Interfacer 2 full RS 232# S100	£99	£125
Econoram IV, 4MHz, 16K Bytes	£150	£169

**EXTRA LOW PRICES ON QUALITY DISKS**

(Verbatim, Scotch, Memorex, etc.) Diskettes stocked for most micro-computers:

Apple, Cromemco, Tandy, Vector Graphic etc. (soft sector mini)

North Star, Polymorphic, Wang etc. (10 sector mini)

Altair, Micropolis etc. (16 sector mini)

DEC, Cromemco, Prime, etc. (soft sector floppy, 8in.)

Pack of ten disks, £19. Carton of ten packs (100 disks), £175

All prices given include postage and packing (overseas add £10). Just add VAT (presently 15%). Send 9p stamp for details.

Quantity discounts available on application. Credit terms (nett 30 days) given to large companies and government establishments.

Mail Order 'phone: 01-828 1785 **LTT ELECTRONICS**  
8 Waldegrave Road  
London SE19

• Circle No. 122

IMS

**SYSTEMS  
HOUSES**

## TAKE YOUR PICK!

**COLLEGES  
SCHOOLS**

### OPERATING SYSTEMS

- CP/M
- PASCAL
- MULTI-USER, MULTI-TASKING
- CAP MICROCOBOL BOS

### WORD PROCESSING SOFTWARE

#### HARDWARE

- Z-80 Processor
- S-100 Bus
- Memory Management to 512KB
- 5 1/4" Floppy Discs (dbl. density)
- 8" Floppy Discs (dbl. density)
- Cartridge Disc Drives (to 40MB)

### MAINTENANCE

- Nation-wide servicing facilities available.

### LANGUAGES

- C-BASIC Compiler
- M-BASIC
- FORTRAN-80
- COBOL-80
- PASCAL
- CAP-Microcobol

### COST OF DEVELOPMENT SYSTEMS (including CP/M and C-BASIC)

- 48KB, dual 5 1/4" Floppies **£1675**
- 48KB, dual 8" Floppies **£2495**
- Exclusive of VAT. Subject to our standard terms and conditions and exchange rate variation.

**EQUINOX**

COMPUTER SYSTEMS LTD.

"KLEEMAN HOUSE"  
16 ANNING STREET,  
NEW INN YARD,  
LONDON EC2A 3HB.  
01-739 2387/9. 01-729 4460.

IMS

• Circle No. 123

IMS

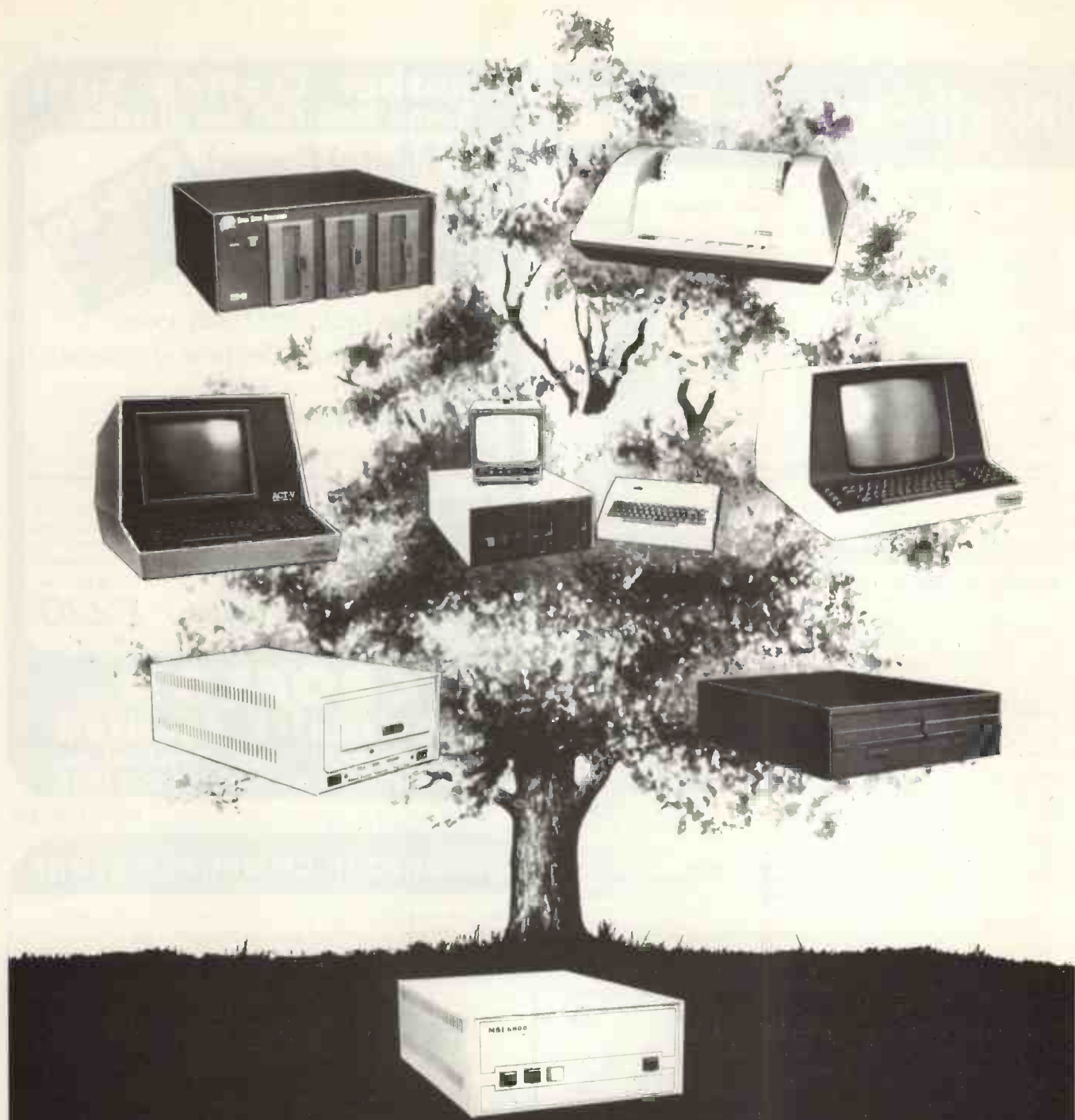

**MSI 6800: At the root of every good system.**

SEED

Strumech Engineering Electronic Developments Limited  
Portland House, Coppice Side, Brownhills, Walsall, West Midlands. Telephone (279) 4321

• Circle No. 124

# NorthStar



## Compatible Software

### ALLAN ASHLEY ENTERPRISES

PDS Program Development System for 8080 or Z80 computers. PDS supports full Z80 code favouring Inter-type mnemonics. £55/£10

The following is a list of source modules compatible with PDS:—

MODULE	FUNCTION	REQUIREMENTS	
ALPHSORT	High speed alphabetic sort	None	£10.00/1
NUMRSORT	High speed numeric sort	None	£10.00/1
FPPACK	BCD floating point arithmetic	None	£10.00/1
FDURIER	Fast Fourier transform	FPPACK	£10.00/1
MINV	Matrix inversion	FPPACK	£10.00/1
MATPED	Matrix product	FPPACK	£ 7.50/1
RATPOL	Rational function and utilities	FPPACK	£ 7.50/1
SORT	Square root	FPPACK	£ 5.00/1
TRIGS	Sine, cosine, TAN, ATAN	FPPACK, RATPOL	£10.00/1
LOGEXP	Exponential, logarithm, yx	FPPACK, RATROL	£10.00/1
FPIOP	Floating point I/O	None	£10.00/1
FORMAT	Formatted floating point output	None	£ 7.50/1
FILES	North Star disc handler	None	£10.00/1
INOPS	Integer multiply-divide	None	£ 6.00/1

The complete set of modules listed above. £49/£10

EZ-80 — A tutorial on the PDS Z80 Instruction set. £10/£3

REGENT — Disc disassembler, generates source file compatible with EDIT and the MAKRO Assembler in PDS. £15/£3

HDS — Hybrid Development System. Permits easier interfacing between assembly code routines and North Star BASIC. £27/£3

CDS — Compiler Development System. The CDS BASIC compiler enables portions of North Star BASIC programs to be compiled into assembly language to achieve increased speed and to protect proprietary sections of code. Requires PDS and HDS. £55/£10

BYTE SHOP OF WESTMINSTER  
North Star BASIC Time Sharing package. £30/£5

DIGITAL RESEARCH / LIFEBOAT ASSOCIATES  
CP/M — General purpose Disc Operating System. £75/£15  
MAC — Macro Assembler. £50/£10  
SID — Symbolic Instruction Debugger. £40/£10  
TEX — TEXT formatter. Enhanced version of CP/M editor, ED. £40/£10  
DESPODL — Spooler for CP/M. £25/£1

INFORMATION UNLIMITED  
WHATSI? — Interactive data-base management system using associative tags to retrieve information by subject. Also available at no extra cost, a modified version (by Interam) which supports cursor addressing and printer output. £50/£15

MICRO MIKES  
4/5 SHARE — General purpose interrupt driven, bank switching timesharing system for the North Star Horizon computer. £25/£2  
CSUB — Common SUBroutines for North Star BASIC. £25/£2

MICROSOFT / LIFEBOAT ASSOCIATES  
Disc Extended BASIC. £145/£15  
FORTRAN-80 — ANSI '66 (except for COMPLEX) plus many extensions. £195/£15  
CDBOL-80 — ANSI '74 Pseudo-compiler with relocatable object runtime package £295/£15  
BASIC Compiler — compatible with Version 5 interpreter £185/£15

MICROPRO  
WORDSTAR Menu driven visual word processing system for use with standard terminals. £70/£15

NORTH STAR  
UCSD PASCAL development system includes an editor, compiler, debugger and file handler. Requires 48K RAM. £30/£15  
PAS-AUX — Auxiliary package for above. includes an assembler and utilities. £20

NSSE/NSUG . . . HUNDREDS OF PROGRAMS FROM MONOPOLY TO PILOT  
NSSE — North Star Software Exchange discs (currently 13 discs in library). Each disc costs £4. Set of thirteen. £35  
NSUG — North Star User's Group discs (currently 45 volumes in library). Each disc costs £4. Set of forty-five. £199  
NSUG/NSSE directory listings (directory listings of all NSSE and NSUG discs, currently 58 discs). £150

ORGANIC SOFTWARE  
TEXTWRITER II — Word Processor/Text Formatter for North Star CP/M users. £45/£3

SOFTWARE WORKS  
INVENTORY-2 — Sophisticated inventory package with order entry, requires minimum 32K RAM and two disc drives. £75/£10

SOFTWARE SYSTEMS / LIFEBOAT ASSOCIATES  
CBASIC-2 Disc Extended BASIC for North Star CP/M users. £65/£15

The above software is supplied on North Star compatible minifloppy discs. Please be sure to specify the density mode you require (releases 1-4: single density, release 5: dual density), the first price given in each instance is for software and documentation, while the second price is for documentation only.

Prices are correct at time of going to press, and are exclusive of VAT at 15% and postage & packing (add 75p). Please send S.A.E. for full details.

Available soon: Applications software, including General Ledger for incomplete records, Accounts Receivable and Payable, Payroll, Hotel packages and more. Software products are being continually added to our range, so please enquire about software products not listed above.

Telex: 925859  
Telephone: 01-834 0261/2733  
Interam Computer Systems Ltd.  
59 Moreton St., Victoria, London SW1.



• Circle No. 125

## Another Crofton First Brand New Full Specification

# 10" Metal Cased Industrial Video Monitor

**£118.80**  
Inc. to Personal  
Callers - Subject to  
availability.

Video Bandwidth 8MZ (3db down).

Ideal for Computer Terminal or General Video Monitor.

Complete With Own Power Supply.

Input Sensitivity IV Composite.

The unbeatable  
**CROFTON 6800 MICRO**  
is probably the best  
value for money today

POWER SUPPLY £20 EXTRA +VAT & P/P

\* Including  
Tiny Basic and  
on board Prom  
Programmer

— KIT\* —  
**£220**  
+ VAT & P/P

# CROFTON Electronics Limited

35 Grosvenor Road, Twickenham  
Middlesex • Tel: 01-891 1923

• Circle No. 126

## CAMBRIDGE COMPUTER STORE

We can help you select the right system for your application. Here in Cambridge your choice won't be limited — we'll demonstrate as comprehensive a range of microcomputers as you'll find anywhere in the U.K.:

# TANDY TRS-80 COMMODORE PET APPLE II N-S HORIZON CROMEMCO SORCERER ACORN NASCOM-1

Stop Press: dramatic reduction now in prices of TRS-80, APPLE II and HORIZON systems. Where possible we deliver off-the-shelf, to any location.

The store is open 6 days a week from 9-5.30 with demonstration systems always in operation. We offer a professional standard of advice and after-sales support and we're ready to discuss your application any time.

## CAMBRIDGE COMPUTER STORE

1 Emmanuel Street, Cambridge (0223) 68155

• Circle No. 127

# Thinking Computers?

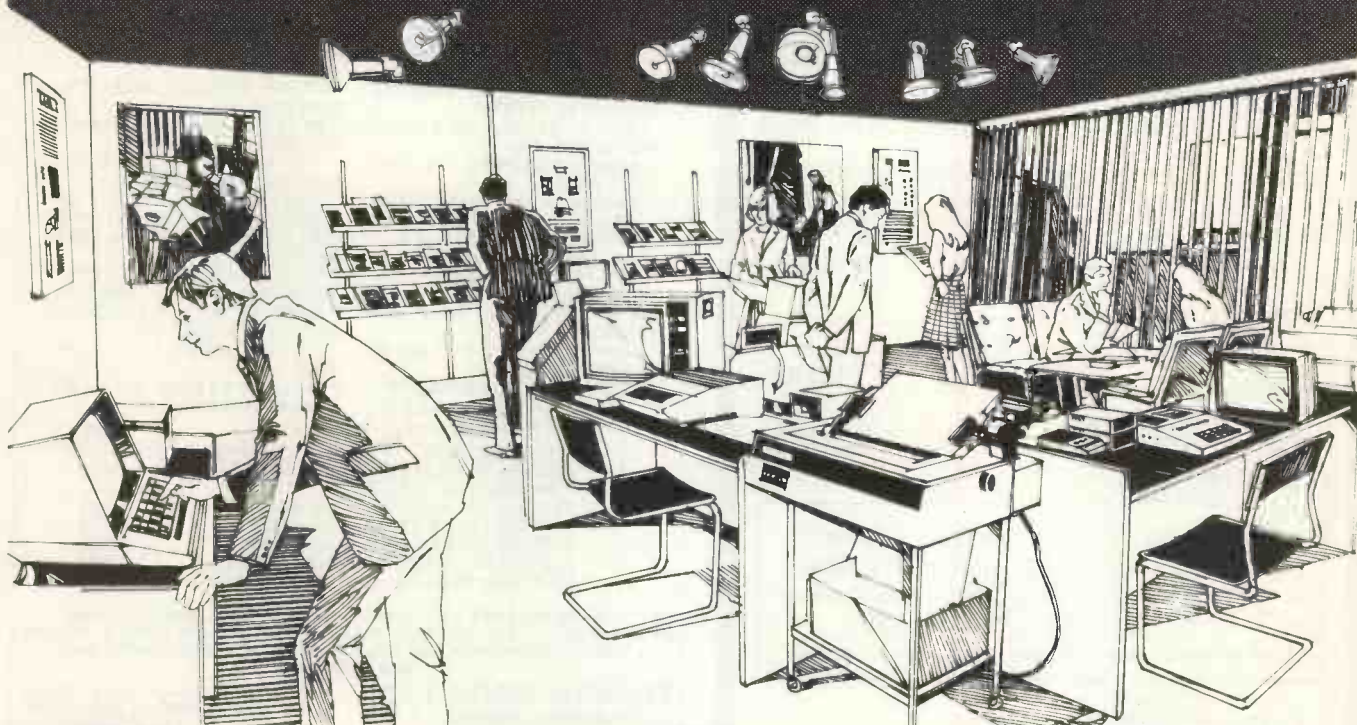

## Then come to the number one micro-computer centre

If you're wondering if a micro-computer can help you, we are here to advise you. At Lion House—London's leading centre for micro-computers—you'll find:

- \* Experts who'll explain the equipment in a way you can easily understand, showing how and where it applies to *your* work.

- \* Demonstration areas where you can get immediate experience of using micro-computers yourself.

- \* Probably the biggest range of software in the UK.

- \* Programmes can be tailored for your particular commercial needs by our In-House Analysts and Programmers.

- \* Total service—including the availability of full maintenance after you've bought an installation.

- \* Leasing and H.P. facilities immediately available.

- \* A computer book section with publications that give you new insight into the world of micro-computers.

**How will micro-computers help you?** In thousands of ways—only a few can be mentioned here...

MICRO-COMPUTERS FOR BUSINESS

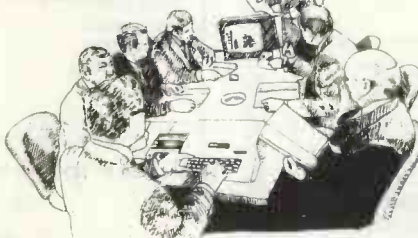

**For business and professional,** the versatility of compact micro-computers means that all the benefits of big computers are made available to all at low cost. The businessman can now computerise his accountancy, his stock control, his records and much more—cutting his overheads and improving his efficiency.

**For the home,** micro-computers have innumerable uses and considerable value too—sometimes in unexpected ways.

MICRO-COMPUTERS FOR THE HOME

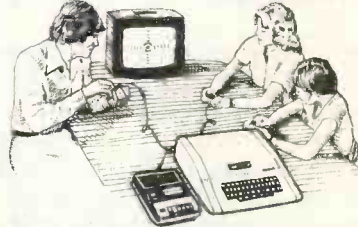

Budgeting... investments... controlling heating or security... storing information on things like recipes... designing complex and fascinating games... education...

**Come and see.** We invite you to visit us and investigate the possibilities and the potential. If you're too far away, phone or write and we'll send you more information.

**You need a micro-computer.** We can supply it.



## LION MICRO-COMPUTERS

SMALL COMPUTERS—TO MAKE YOUR BUSINESS BIGGER

Lion Computer Shops Ltd, Lion House, 227 Tottenham Court Road, London W1 (First Floor). Telephone: 01-637 1601.

Telex: 28394 Lion G.

Open 9 to 6, Monday to Saturday (Thursday to 7).



• Circle No. 128



# CUT PRICE computers

Computers	R.R.P.	Our Price
Pet 2001 - 8K	£550	£485
Pet 2001 - 32K	£795	£699
<b>Floppy Disc</b>		
Pet 2040	£795	£699
<b>Printers</b>		
Pet 2023		
Friction Feed	£550	£485
Pet 2022		
Tractor Feed	£645	£565

## SPECIAL OFFER

Comprint 912 Printer a reliable low cost, full width, electronic printer with a speed of 225 characters per second. Compatible with PET. **SPECIAL PRICE £395**

Electrosensitive paper available from ourselves.

### External Cassette

Decks \_\_\_\_\_ £55 \_\_\_\_\_ £48

### Cables

IEEE to PET \_\_\_\_\_ £20 \_\_\_\_\_ £17.50  
IEEE to IEEE \_\_\_\_\_ £25 \_\_\_\_\_ £22.00

**COMPUTHINK - 800K Double Density Dual Disc drive for PET 2001-16 and 2001-32** £995

All above prices subject to 15% v.a.t.

All above machines carry a 90 day warranty. Service contracts available.

H.P. and leasing facilities.



Should you require any equipment not shown in the above list please ask **LOGITEK** to quote you before buying elsewhere - we could save you £££s.

**We hold large stocks of all the above machines.**

### MAIL ORDER

Add 15% VAT & 2% for carriage to all the above prices.

Please send .....

I enclose cheque for £ .....

Please debit my Access/Barclaycard

Account No. ....

Name .....

Address .....

..... Tel No. ....



E.I.C. Electronics Ltd.,  
30 Kelvin Ave., Hillington  
Industrial Estate, Glasgow  
Tel: 041-882 1661/2/1166

• Circle No. 129

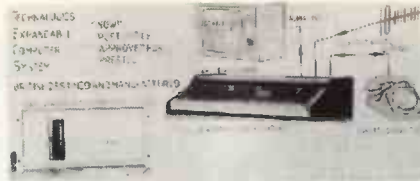

### TECS: FEATURES

- \* VIEWDATA AND PRESTEL DATABASE ACCESS
- \* FULLY EXPANDABLE COMPUTER SYSTEM
- \* MEMORY-MAPPED TV DISPLAY RAM
- \* 24ROW x 40 CHARACTER, ALPHANUMERIC AND GRAPHICS (224 individual symbols) DISPLAYED IN SIX COLOURS PLUS B&W, ON UNMODIFIED COLOUR T.V.
- \* EXPANSION TO FULL 64K MEMORY
- \* SUPPORTS BOTH 5 1/4" and 8" FLOPPY DISCS
- \* RS232 PORT AS STANDARD
- \* 3K TECS MINI-BASIC, INTEGER VERSION WITH COLOUR DISPLAY
- \* 8K TECS BASIC; FULL FLOATING POINT VERSION
- \* TECSBUG: POWERFUL MACHINE CODE MONITOR
- \* TECSOFT RANGE OF SOFTWARE TO EXPLOIT THE FULL POTENTIAL OF THE TECS SYSTEM
- \* FULL FACILITY TELETEXT RECEPTION (CEEFAX, ORACLE)
- \* KANSAS CITY STANDARD CASSETTE INTERFACE
- \* FULL DOCUMENTATION PACK
- \* ALL SYSTEMS CAN BE EXPANDED LATER;

SYSTEM T1 TELETEXT, 3K BASIC KIT	BUILT
4K USER RAM	£895
8K BASIC, 4K USER RAM	£1175
SYSTEM T2 TELETEXT, MONITOR, 8K BASIC, 4K USER RAM	£1115
SYSTEM T2a AS T2 but +16K RAM	£1335
SYSTEM T2b AS T2 but +32K	£1435
SYSTEM T2c AS T2 but +48K	£1535
SYSTEM T4 'PRESTEL SYSTEM' TELETEXT, PRESTEL, 4K RAM, 3K BASIC	N/A
	£1955

(KITS AVAILABLE DIRECT FROM TECHNOLOGICS ONLY.) PLEASE SEND FOR FURTHER DETAILS (LARGE S.A.E., 13P STAMP PLEASE) OR ORDER NOW (SPECIFY RACK OR TABLETOP VERSION) FROM YOUR DEALER OR IN CASE OF DIFFICULTY DIRECT FROM TECS SALES DEPT.,

### TECHNOLOGICS LTD.,

8 EGERTON STREET, LIVERPOOL L8 7LY Tel: 051-724 2695

ALL ORDERS DEALT WITH IN STRICT ROTATION, CARRIAGE AND INSURANCE PAID. ALL PRICES SUBJECT TO 15% VAT.

• Circle No. 130

# BIRMINGHAM COMPUTER CENTRE

Commodore  
Authorised agents  
PETSOFT DIST.  
PETACTION  
business  
programs



Specialists in  
Commodore  
Hardware  
ALL MODELS  
EX STOCK

2001-4K 2001-8K 2001-16K 2001-32K

All at special discount prices including large keyboard

Floppy dual disk drive — Printers

KIMI BETSI — KIMSI, etc

Cassette tapes super quality

Diskettes — super quality

Our range of products now extended to include: New Apple II plus auto-start ROM (direct entry) PALSOFTE ROM (saves RAM). New low price from £830.

Exidy Sorcerer plug-in ROM cartridge S100 expansion Z-80 CPU word from 760 16K.

Midland stockists of Grama Winter Software.

Camden BD 80 Printer professional business use. 2K character buffer Now available ex stock £675 —

Send for free literature

HP terms available

Showrooms open Mon to Sat, 10am-6pm  
Camden Electronics (first floor) 462 Coventry Road,  
Small Heath, Birmingham B10 0UG Tel: (021) 7738240

• Circle No. 131

**AUTHORISED  
PET  
COMMODORE  
DEALERS**

**Birmingham**  
Camden Electronics  
021-773-8240

**CPS (Data Systems) Ltd**  
021-707-3866

**Taylor Wilson Systems Ltd**  
Knowle 05645-6192

**Bolton**  
B & B Consultants  
0204-26644

**Bournemouth**  
Stage One Computers  
0202-23570

**Bradford**  
Ackroyd Typewriter &  
Adding Machine Co  
0274-31835

**Brentwood**  
Direct Data Marketing Ltd  
0277-229379

**Bristol**  
Bristol Computer Centre  
0272-23430

**Sumlock Tabdown Ltd**  
0272-26685

**Cambridge**  
Cambridge Computer Store  
0223-68155

**Cardiff**  
Sigma Systems Ltd  
0222-21515

**Colchester**  
Dataview Ltd  
0206-78811

**Derby**  
Davidson Richards (Int) Ltd  
0332-366803

**Durham**  
Dyson Instruments  
0385-66937

**Edinburgh**  
Micro Centre  
031-225-2022

**Exeter**  
A.C. Systems  
0392-71718

**Grimsby**  
Allen Computers  
0472-40568

**Hemel Hempstead**  
Data Efficiency Ltd  
0442-57137

**Hove**  
Amplicon Electronics  
0273-720716

**Leeds**  
Holdene Ltd  
0532-459459

**Liverpool**  
Aughton Automation  
051-548-6060

**Cortex Computer Centre**  
051-263-5783

**Dams Office Equipment**  
051-227-3301

**London E2**  
Ragnarok Electronic Systems  
01-981-2748

**London EC1**  
Sumlock Bondain Ltd  
01-253-2447

# THE PET



**Britain's no.1  
micro-computer  
from**

 **commodore systems**

**the complete system  
full range of peripherals  
nation-wide dealer  
sales and service**

**In case of difficulty contact  
COMMODORE SYSTEMS DIVISION  
360 Euston Road, London. Tel: 01-388-5702**

**AUTHORISED  
PET  
COMMODORE  
DEALERS**

**London N14**  
Micro Computation  
01-882-5104

**London NW4**  
Da Vinci Computers  
01-202-9650

**London SW14**  
Micro Computer Centre  
01-876-6609

**London W5**  
Adda Computers  
01-579-5845

**London WC1**  
Euro Calc Ltd  
01-405-3113

**London WC2**  
TLC World Trading Ltd  
01-839-3893

**Manchester**  
Cytek (UK) Ltd  
061-832-7604

**Executive Reprographic**  
061-228-1637

**Sumlock Electronic Services**  
061-834-4233

**Matlock**  
Lowe Electronics  
0629-2817

**Morley, W. Yorks**  
Yorkshire Electronic Services  
0532-522181

**Norwich**  
Sumlock Bondain  
0603-26259

**Nottingham**  
Betos (Systems) Ltd  
0602-48106

**Oxford**  
Orchard Electronics  
0491-35529

**Plymouth**  
JAD Integrated Services  
0752-62616

**Preston**  
Preston Computer Centre  
0772-57684

**Reading**  
CSE Computers  
0734-61492

**Southampton**  
Business Electronics  
0703-738248

**Symtec Ltd**  
0703-37731

**Xitan Systems**  
0703-38740

**Sunderland**  
Tripoint Associated Systems  
0783-73310

**Woking**  
P.P.M. Ltd  
Brookwood 04867-80111

**Petalect Ltd**  
04862-69032

**Yeovil**  
Computerbits  
0935-26522

**North Scotland**  
Thistle Computers  
Kirkwall 0856-3140

**Northern Ireland**  
Medical & Scientific  
Lisburn 08462-77533

• Circle No. 132

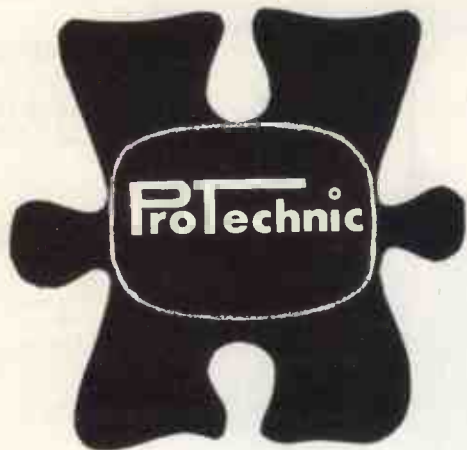

## WE HAVE ALL THE PIECES!

COME TO CAMBRIDGE AND SEE THE SOLUTION

We can demonstrate practical business systems,  
with proven software, for many applications.

Leasing, installation and training available.

PROTECHNIC COMPUTERS LTD.

264 Newmarket Road, Cambridge.

0223 - 314855

• Circle No. 133

## MICROSPEECH

Does your computer speak to you?  
'WEHL IHT KAN DOO WIHTH MEE!'

### Features

- Single PCB plugs directly into an SWPTc 6800 bus.
- 9 parameter vocal tract model.
- Realtime software converts any stored phonetic code to speech.
- Computer Games.
- External input for special musical effects.
- Adds speech output to existing BASIC programs.

### Microspeech package

- Speech synthesizer board (assembled & tested).
- MSP2 Software on floppy disc or cassette.
- Hardware & Software manual.
- Speaking BASIC software option.

**TIM ORR DESIGN  
CONSULTANT**  
55 Drive Mansions,  
Fulham Road,  
London, SW6

### Make your computer talk

Just by entering phonetic text (as in the sentence at the top of the page). Microspeech with the MSP2 software can make your computer speak. MSP2 uses only 4K of memory. Every extra 1K of buffer space can store 90 seconds of speech.



It speaks for itself

**COSTRONICS  
ELECTRONICS**  
13 Field Heath  
Avenue, Hillingdon,  
Middlesex

• Circle No. 134

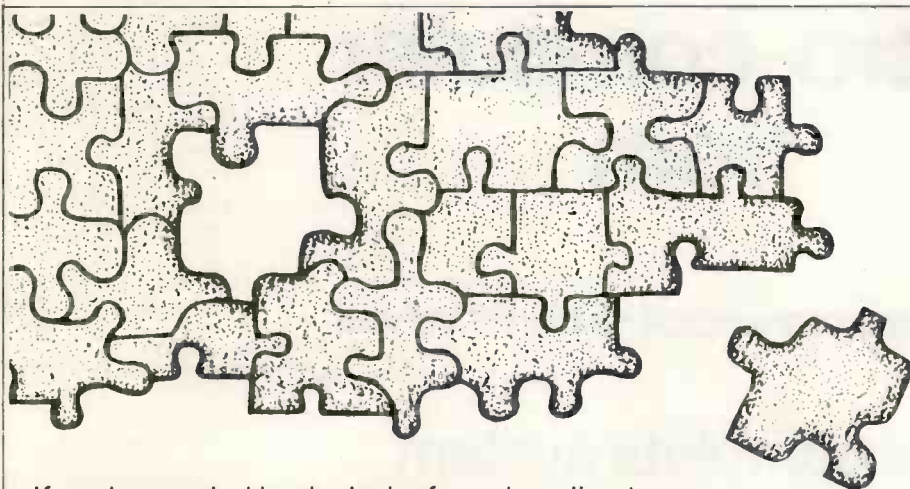

## SERENDIPITY SYSTEMS SOLVE THE SOFTWARE PUZZLE

If you're puzzled by the lack of good application software for micro-computers – then puzzle no longer! Great Northern Computer Services are now the distributors for the Serendipity Systems range of packages and we are looking for dealers.

Stock Control, Ledgers, Payroll, Job Order Control, Professional Client Billing, Appointments and many more. The Programs conform to British practice and the manuals are user-oriented; so there is no puzzle there either.

The programs are offered in CBASIC, Cromemco Extended BASIC and North-Star BASIC. There are also packages for the Apple. Over 1800 packages have already been sold by more than 200 dealers and retailers. So stop puzzling and write or call today!

**GREAT NORTHERN** Computer Services

15 Wellington Street, Leeds LS1 4DL Telephone (0532) 450667

• Circle No. 135



# MacroFloppy<sup>TM</sup> goes twice the distance

Micropolis is rapidly becoming the industry standard in 5¼" floppy disc drives; they have been shipping double density drives for over 2 years, thus proving their outstanding reliability and performance.

By completely reassessing the engineering involved in 5¼" floppy disc drives, and using the most modern technology available, Micropolis achieve a formatted density of 315K bytes per single sided unit.

## Starter system

The 1041/1 Macrofloppy system includes a 143K byte double density drive with S100 controller card, MDOS and BASIC with a comprehensive manual.

This unit will successfully add on-line disc storage to a wide range of S100 computers at an unbeatable price per byte.

Add to your **Cromemco, North Star, Vector Graphic, Sol, Poly 88, Sorcerer, etc.**

Fully assembled, tested and burnt-in unit  
£439.00

Optional regulator for S100 raw power  
£14.00

## Also available

A full range of hardware and software including:

Mains powered add-on 143K bytes (Also suitable for **Tandy** expansion interface)  
£399.00

Single drive 315K byte system  
£663.00

Twin drive 630K byte system  
£1159.00

CPM  
£100.00

**North Star** compatible operating system  
£35.00



**Dealer enquiries welcome**  
**Ring Reading 85464 for further details**



## SINTROM MICROSHOP

14 Arkwright Road, Reading, Berks RG2 0LS  
Tel: Reading (0734) 85464  
TELEX: 847395 CABLES: SINTROM READING

## DATABANK (Software Services) PROGRAMS GALORE!!

GAMES		EDUCATIONAL	
Lost in Space	£ 8	Elementary Maths	£ 5
Star Trek-1	£ 6	Advanced Maths	£ 7
Star Trek-2	£ 8	Ele. Statistics	£ 7
Drag racer	£ 4	Adv. Statistics	£ 5
Noughts & crosses	£ 4	Ele. Physics	£ 7
Hangman	£ 4	Adv. Physics	£ 6
Take your poison	£ 5	Ele. Chemistry	£ 4
Battleships-1	£ 7	Hyperbolics	£ 5
Nim	£ 4	Adv. Electronics	£ 7
Spook	£ 4	Ele. Geometry	£ 5
Card Dealer	£ 3	Adv. Geometry	£ 7
Ticktackoe	£ 4	Ele. Integration	£ 6
Craps	£ 5	Vector analysis	£ 6
Space wars	£ 8		
Pontoon (21's)	£ 5	BUSINESS	
Jet flight-1	£ 5	Payroll	£20
Dice thrower-1	£ 4	Sales & Purch. Led.	£20
Oil tanker	£ 6	Stock Control	£25
Bridge hand dealer	£ 4	Std. letter printer	£15
Numbers battle	£ 4	Sim/compound Int.	£10
One armed bandit	£ 4	Tax depreciation	£10
Spies	£ 5	Bank account tally	£ 6
Racing car	£ 5		
Lunar lander	£ 6	MISCELLANEOUS	
Mastermind-1	£ 5	Calendar printer	£ 5
Spook	£ 4	Primes generator	£ 5
		Racing analysis	£25

All programs on cassette for: PET, TRS-80, SORCERER, APPLE 2 & NASCOM; otherwise we can supply printout. Please state which when ordering.

S.A.E. now: for catalogue with details of over 100 programs. Prices include Post and Package.

Cheques/Postal orders to: **DATABANK,**  
**66, QUEENS ROAD,**  
**LOUGHBOROUGH,**  
**LEICESTERSHIRE LE11 1DH.**

*(Mail order only).*

• Circle No. 137

## SLOUGH MICROSHOP

*We stock:*

Commodore PET  
Exidy Sorcerer  
North Star Horizon

*Full demonstration equipment available  
now.*

Extra services include:

A complete hardware maintenance  
service

A software service; tailor-made  
or packaged software available

**Call in at our shop**

**120 High Street,  
Slough, Berkshire**

**Tel: Slough 22855**

• Circle No. 138

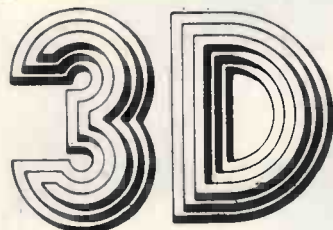

# Digital Design & Development



**APPROVED**

**43 Grafton Way, London W1P 5LA**

**Tel: 01-387-7388**

## PRINTER INTERFACES FOR THE NEW SHARP MZ-80K MICRO COMPUTER

### \* PARALLEL PRINTER INTERFACE (PPI)

This interface will drive most parallel printers, such as the Centronics 730, 779, Anadex DP8000, etc. Supplied boxed complete with ribbon cables and connectors for the Sharp MZ-80K and the printer.

### \* SERIAL PRINTER INTERFACE (SPI)

This interface provides both RS232C and 20 mA Current Loop outputs. Switch-selectable crystal-controlled baud rate in the range 50 — 19,200 baud. Supplied boxed complete with power supply, ribbon cable, and connector for the Sharp MZ-80K, and D-type connector for printer, VDU etc.

\* 3 D SPECIALISES in microcomputer interfaces for industrial, medical, and educational applications.

Wide range of analogue and digital input/output interfaces are available for microcomputers with IEEE-488 Bus. These include digital data acquisition system, analogue data acquisition system, D to A converters, etc.

Range of custom interfaces supplied: —

Stepper motor, Spectrophotometer, Transient recorder, NC Tape Generation System, BS4421 to IEEE-488, Floppy Discs, Noise-Level meters, etc.

Quotations supplied against customer's specification.

• Circle No. 139

# The portable brain



## Sharp personal computer

- \* Z-80 based CPU
- \* 4K bytes monitor ROM
- \* Internal memory expansion up to 48K bytes of RAM
- \* 14K extended basic (occupies 14K bytes of RAM)
- \* 10 in. video display unit—40 characters x 25 lines display
- \* 80 x 50 high resolution graphics
- \* 78 key ASCII keyboard—alphabet (capital and small) plus graphics
- \* Built in music function
- \* Fast reliable cassette with tape counter—1200 bits/sec
- \* 50 pin universal BUS connector for system expansion—printers, floppy discs etc.

Amazing it may be, but that should come as no surprise since the 'Portable Brain' comes from Sharp, who produced the world's first equally amazing Portable Desk Top Calculator. Who else would you expect to be first again with the 'Portable Brain'—a micro-computer with some very remarkable features, made just by Sharp. Find out about the National Sales & Services Network which has been built-up by Sharp to look after this very special piece of advanced technology. Find out more about what it can do for you, by filling in this coupon right away!

## Insist on



Audio, Video, Business Systems, Calculators,  
Cash Registers, Copiers, Microwave Ovens.

SHARP Electronics (UK) Ltd.,  
107 Hulme Hall Lane, Manchester M10 8HL. Telephone: 061-205 7321.

## Trust Sharp to make it.

I would like to know more about the 'Portable Brain'. Send me the full facts now about how it can help me!

Name

Address

Tel:

Sharp Electronics (UK) Ltd., 107 Hulme Hall Lane,  
Manchester M10 8HL. Tel: 061-205 7321

PCN

• Circle No. 140

LEASE A  
PET OR A  
COMPLETE  
SYSTEM FROM  
£5 A WEEK (+ VAT)

FOR  
AIM 85

INTERFACES  
TO  
PETITE  
MEMORY  
£120  
+ VAT

FOR PET

INCOMPLETE  
RECORDS  
ACCOUNTING  
£750 — £2,900  
+ VAT  
SOFTWARE & HARDWARE

C12 TAPES  
£4 FOR 10  
DISKETTES  
£34 FOR 10  
INC. VAT  
+ 50p P&P

WIDE  
RANGE  
OF BUSINESS PROGRAMS

M  
I  
C  
R  
O

COMPUTATION

8 STATION PARADE  
SOUTHGATE LONDON N.14  
882 5104

• Circle No. 141

## ANNOUNCING

S100 Teletext Format. Colour VDU card with keyboard. Port to operate with colour monitor: from the company that designed and built the BBC Ceefax formatting terminals.

KITS £149, BUILT AND TESTED, £209  
+ VAT

### S100 OFF AIR RECEIVER AND MODULATION CARD

To operate with VDU card and  
enable OFF AIR reception and  
display via a TV set.

Available from October. Enquiries from dealers  
welcome

LEENSHIRE LTD.  
13 Cathedral View,  
Winchester, Hampshire  
SO23 8PR  
Tel: 0962 3675

• Circle No. 142

SAIL

## COMPUTER SYSTEMS

the micro division of Software Aids International Ltd.

### COURSES

at the weekend for busy people.

#### INTRO to MICROS

1. For businessmen (non technical) w/e 27-28 October.
2. For beginners (general) w/e 3-4 November.
3. For mainframe programmers w/e 10-11 November.

#### COBOL on MICROS

4. For beginners w/e 17-18 November.
5. For programmers w/e 24-25 November.

#### BASIC

6. For beginners w/e 1-2 December.

Take first day only if you prefer.

LOCATION: Central London

COST — 1 day £35.00  
2 days £60.00  
(+ VAT)

#### EARLY BOOKING ESSENTIAL

### PACKAGES

by professionals

We pride ourselves in our  
a) package content of application features.  
b) comprehensive documentation for easy use.  
c) backup in training, implementation assistance etc.

Systems include:  
ORDER PROCESSING  
INVOICING  
SALES LEDGER  
SALES ANALYSIS  
PURCHASES LEDGER  
NOMINAL LEDGER (with Budgetary Control)  
JOB COSTING  
PAYROLL  
Available in  
COBOL or  
BASIC

Your suggestions welcomed for development at package prices.

### PROGRAMMING

for your machine

in

COBOL — The professional language for commercial applications on machines where CP/M is available (we can advise).

BASIC — For the smaller machine, in any variant.

SYSTEM DESIGN — Undertaken by well qualified Consultants.

We are quite happy to work evenings and weekends to leave your machine free for your daytime use.

Regrettably, due to demand, we can only offer this service in the London and Home Counties areas.

Please allow our principal consultant (a qualified accountant) to visit you and discuss your requirements.



COMPUTER HARDWARE to run these systems supplied.

Computer Systems, Embassy Lodge, 167 Green Lanes, London N16. Telephone: 01-359 2818

Please book me on Course No. \_\_\_\_\_ No. of days \_\_\_\_\_ (1 or 2) \_\_\_\_\_ (Remittance enclosed)

Please send me details of

Course(s) No.(s) .....

Package(s) for .....

Programming Services in COBOL  BASIC  (Please Tick)

Name .....

Company .....

Address .....

• Circle No. 143

Unleash your Pet\* to its full capability.



## Two ways to 32K. Add on or add in.

### One way: Petite memory system.

- Self-contained peripheral for any Commodore Pet.
- Plugs into mains and Pet.
- No modifications required.
- No demands on Pet power supply.
- No extra heat dissipation within Pet cabinet.
- No warranty problems.

### The Other: Inpet memory board.

- Mounts onto Pet processor board.
- Built in PSU.
- Simple to fit.
- Complete with all connectors.
- Low cost version.

\* Trademark of Commodore Business Systems.

One way or the other you get a reliable memory from Plessey Microsystems, Europe's leading memory manufacturer. Either way you get a memory to make your Pet more like a powerful business computer.

Available from authorised distributors of Plessey Pet peripherals. Send for full information and the address of your nearest distributor.



**PLESSEY**  
MICROSYSTEMS

Plessey Microsystems Limited, Water Lane, Towcester, Northants NN12 7JN Telephone: Towcester (0327) 50312 Telex: 31628

# A.P. Ltd

## Hardware

The *MAPLE*, our own micro-APL computer. Also APL VDUs, terminals.

## Software

Word processing, financial modelling, graphics, statistics, etc. *Custom-written software* is our central function — our analysts produce stable APL systems in a *small fraction* of the time that anyone else can, using conventional languages. Own your own *APL interpreter* — we have source code for a micro-APL implementation.

## Courses

*APL language* — a thorough grounding;  
*APL implementations* — an overview of practical APL;  
*APL for Analysts* — a much neglected aspect of APL;  
*Writing an APL Interpreter* — for the serious micro-systems programmer.

## Books

We have a wide selection of APL books.

For details on any of these areas, telephone Chester (0244) 46024 /21084 between 10am-8pm weekdays, or write to A.P. Limited, FREEPOST, Chester CH3 5YZ.

• Circle No. 145

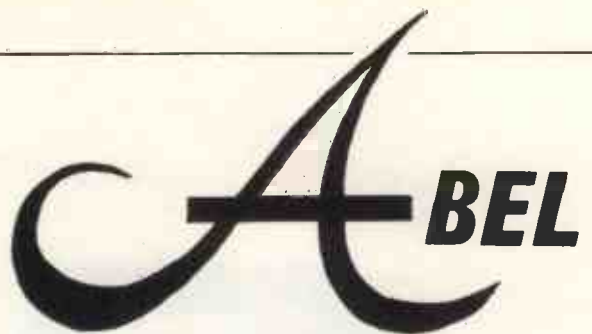

## ABEL COMPUTER SYSTEMS LIMITED 5 HANLITH WILNECOTE TAMWORTH STAFFS B77 4BP

BLANK SHORTPLAY DATA CASSETTES  
10 Quality Cassettes with Library Cases £5.10

BLANK DISKETTES Single-Sided — Soft-Sector'd  
(Suitable for APPLE, PET, Etc.)

Certified Diskettes of the Highest Quality by a Renowned Manufacturer £3.15 EACH

APPLE-II SOFTWARE ON DISKETTE (Minimum 32K APPLE)  
Games pack Vol. 1: 8 games for £10.00

Integer Basic Utilities — Renummer, Merge, Cross-reference, Name Finder, etc. £10.00

Symbolic Assembler with comprehensive instruction manual £20.00

APPLE-II SOFTWARE ON CASSETTE  
Games Pack Vol. 1: 8 games on 2 cassettes (Minimum 16K APPLE) £8.30

CASSETTE DUPLICATION  
S.A.E. for details

LAST MONTH AT INTRODUCTORY PRICES  
PRICES INCLUDE VAT.  
Add 30p to total order for packing/postage

• Circle No. 146



# ROCKLIFF

2 RUMFORD STREET LIVERPOOL L2 8SZ

P.E.T.

APPLE

I.T.T.

HEWLETT  
PACKARD

KIM

COMPUTHINK



PRINTERS	
TELETYPE 43	£795
CENTRONICS 779	£795
ANADIX 8000	£580
C.B.M.	£645
PR40 (for PET)	£250
DISC DRIVES	
C.B.M.	£795
COMPUTHINK	£840
APPLE	£398
PET MEMORY	
24k BOARD	£320

APPLE INTERFACES	
HIGH SPEED SERIAL	£110
PARALLEL	£110
CENTRONICS CARD	£132
COMMUNICATIONS	£132
CLOCK CARD	£140
HEURISTICS SPEECH	£127
A1/02 DATA ACQUISITION	£170
ALF SYNTHESISER	£215
PASCAL & LANGUAGE	£296
INTEGER FIRMWARE	£110
EUROCOLOUR	£69

PET INTERFACES	
RS232 UNI	£89
RS232 BI	£140
RS232 BI 20ma	£180
UHF TV	£25
JOYSTICK	£25
<b>HIRE PART-EX</b>	
PLEASE ASK FOR OUR PRICE	

ACCESSORIES	
10 C15 CASSETTES	£3.50
10 C60 CASSETTES	£4.50
10 5 1/4" FLOPPY DISCS	£30
10 PR40 ROLLS	£6
1000 8x12 LISTING	£6
1000 11x9 1/2 LISTING	£5
TELETYPE 43 RIBBONS	£5.50
ANADIX 8000 RIBBONS	£3.50
HEAD DEMAGNETISER	£5

OVER 400 BOOKS AND PROGRAMMES AVAILABLE (ASK FOR OUR PRICE LIST)

PLEASE ADD  
15% VAT  
TO ALL PRICES

# 051-521 5830

• Circle No. 147

# XITAN SYSTEMS

THE SOUTH'S PREMIER MICROCOMPUTER SUPPLIER.

WE SUPPLY SYSTEMS — LOOK AT THESE TYPICAL CONFIGURATIONS!

\*LOOK AT THESE  
NEW PRICES\*

System A 32K Commodore PET + Commodore model 2040  
Dual floppy drives and cable. £1,610



System B NORTH STAR HORIZON, 32K RAM, dual  
double-density drives, 2 serial, 1 parallel port,  
DOS and BASIC, high-quality brand name 24 x  
80 char VDU £2,065



System C CROMEMCO System 2, 4MHz Z-80, 64K RAM,  
dual minifloppies, 21 connectors, 1 serial, 1  
parallel printer port, CDOS 1.07 and Extended  
Disk BASIC High-quality brand name VDU  
etc £2,735

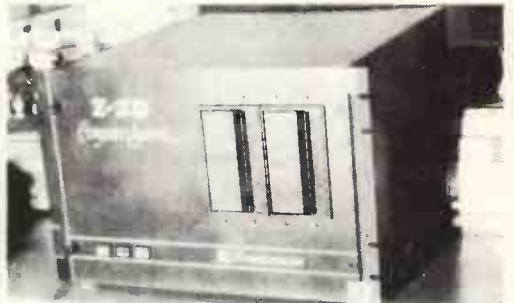

System D CROMEMCO Z-2, 4MHz, 1 megabyte floppy disk  
storage, 64K RAM, 3 serial ports, 2 parallel ports,  
CDOS 1.07 and BASIC, High-quality 24 x 80 char  
VDU £4,600



System E CROMEMCO System 3 (the "Rolls Royce") 64K  
RAM, 4MHz, 1 megabyte floppy disk storage, 1  
serial and 1 parallel printer port, high-quality  
brand name 24 x 80 char VDU etc, including  
CDOS and BASIC £5,130



2-2H 10Meg hard disk systems now available.

*We supply Centronics, Teletype 43 and Diablo Printers, plus the normal range of ancillary equipment. CPIM for Cromemco and Horizon systems is available from us, as well as Microsoft Fortran, Tex etc.*

**23 Cumberland Place, Southampton SO1 2BB.**

**Tel (0703) 38740 Tues-Sat**

• Circle No. 148

# MICRO TASK LTD.

HAS BEEN FORMED TO PROVIDE SYSTEMS AND TECHNICAL ADVICE TO BUSINESSES CONSIDERING THE USE OF MICROCOMPUTERS —

- To help you to decide if a MICRO would be of use to you
- To help you design an effective system
- To help you negotiate with your computer and software suppliers

**MICRO TASK LTD,**  
COMPUTER CONSULTANTS,  
11 DUNLIN CLOSE,  
SOUTH WOODHAM FERRERS,  
CHELMSFORD, ESSEX CM3 5SA.  
Tel: Chelmsford 322055.

• Circle No. 149

# EQUINOX 300

A powerful multi-user  
multi-tasking  
multi-language

16-bit microcomputer time-sharing system

supporting

- BASIC
- LISP
- PASCAL
- Floppy discs
- Hard discs

including a powerful Text Formatter,  
Assembly Language Development System  
and disc-based Sort utilities.

Priced from **under £5,000**

Write or phone for further information.

## EQUINOX COMPUTER SYSTEMS LTD

"Kleeman House" 16 Anning Street,  
New Inn Yard, London EC2A 3HB.  
Tel: 01-739 2387/9. 01-729 4460.

• Circle No. 150

## MICROCONTROL — THE INTERFACE EXPERTS

224 EDGWARE ROAD  
LONDON W2  
Tel 01-402 8842



MICRO CONTROL have been building specialised hardware and writing software, since Apple first came into the country. We can interface your Apple to *anything* with a custom designed card for a reasonable price. We can also provide Business Systems for Apple II and Micro Star to your requirements.

Centronics Printer Card £140.00  
Apple disk drive £375.00  
with controller card £425.00  
Micro Hush Printer  
+ Apple Interface £266.00  
Thermal paperroll for Micro Hush £2.00  
10in b/w monitor £132.00  
12in b/w monitor £210.00  
Apple Pascal £296.00  
MicroStar £4,950.00  
Printers VDU's ITT Apples Software & one-off's P.O.A.  
COMING SOON: —  
Colour board for Apple. Have your text in colour! Clean Lores hires colours £147.00  
Micro Con. Real Time Clock. Date/Hr/Minute £90.00  
8-Channel Mains Controller £140.00  
4-Channel Mains Dimmer £175.00

4-Channel A/D cards 12-bit £174.00; 8-bit £127.00  
4-Channel D/A 12-bit £149.00; 8-bit £110.00  
16K Add In 150ns £58.00  
Apple II 16K £810.00  
High Speed Serial Card £110.00.  
Com. Card £140.00  
Integer Firmware Card (inc. Mini-Assembler) £110.00  
Symtec light pen (for Apple) £165.00.  
Apple Voice recognition Card £165.00.  
Micro Products Eprom burner £140.00.  
Box of 10 diskettes £30.00.

• Circle No. 151



# STOP PRESS

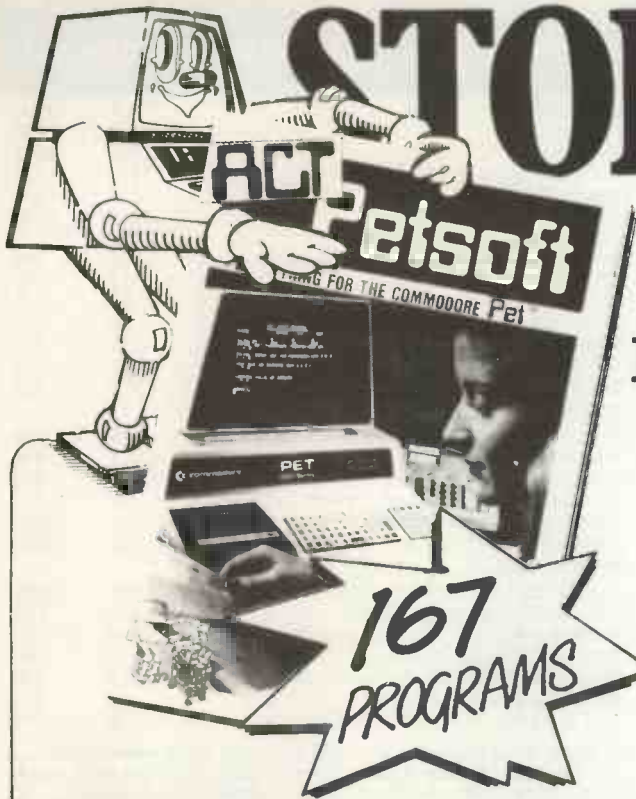

## ... 44 NEW PROGRAMS for the PET in the latest PETSOF T CATALOGUE including ...

**167 PROGRAMS**

**6502 FORTH £30** FORTH is a unique threaded language that is ideally suited for systems and applications programming on a PET. The user may have the interactive FORTH Compiler/Interpreter system running stand-alone in 8K to 12K bytes of RAM. The system also offers a built-in incremental assembler and text editor. Since the FORTH language is vocabulary based, the user may tailor the system to resemble the needs and structure of any specific application. Programming in FORTH consists of defining new words, which draw upon the existing vocabulary and which in turn may be used to define even more complex application. Programs written in FORTH are compact and very fast.

**PHOTOGRAPHY TUTOR £12** A comprehensive course developed by a professional photographer making full use of PET's dynamic graphics capabilities to demonstrate and explain the mysteries of exposure, focus, aperture, shutter speeds, interchangeable lenses, depth of field, etc. The theory and practice of photography are explored interactively and progress tested. Multiprogram pack containing eight 7K lessons. Available on Disk £15.

**HUNT £10** A new concept in fantasy simulations which has achieved wide acclaim. The context is that of a search for a defined object, typically Atlantis or the Holy Grail. The objective, the names and natures of the searchers, their antagonists and the properties of the space in which the hunt is conducted are defined -- by you!

**PAYROLL — 400 (Disk) £50** A totally new and complete disk based payroll system designed and written to meet the needs of small businesses. Up to 400 employees per disk are catered for. A 32K PET 2001-32 equipped with dual floppy, an Anadex DP800 or device 4 printer is required.

Facilities provided include Holiday Pay, Sick Pay, Bonus payments and two rates of overtime, as well as allowing a "standard week" to be specified for each employee. Weekly and monthly summaries are provided and amendments necessary because of a Budget (e.g. increasing employee's tax codes) are made very easy. Each week a wage slip is printed for each employee followed by an analysis of the coins/notes required for these employees paid in cash (payments by cheque and credit transfer are also allowed for). Tax and N.I. are computed automatically from a knowledge of the tax code and N.I. rate applicable to that employee. Update service available.

**JOB EVALUATION £25** Conducts the evaluation necessary to establish pay structures and grades. Program computes correct weightings for factors — education, training, necessary responsibility over other men and equipment, working conditions etc. — which comprise job value. A Job Evaluation Formula is created for use as a guide to the relative value of a job based on the thinking of the company or department concerned.

**STOCK CONTROL ON DISK £25** Facilities allow full or operational stock print out, total costing of items in stock and re-order level warning. Data is stored under Reference, Description, Supplier, VAT Rates, On order Quantity, Quantity in Stock, Unit of Quantity Designated, Minimum level, Stock allocated, Sale Price and Purchase Price. Approx 400 items per diskette.

**COURSE HANDLER £95** A must for School Timetablers. The program handles all the information relevant to creating a 4th, 5th or 6th year Option Scheme and is particularly useful where an "Open Choice" of subjects is offered to pupils. The program maintains, via a simple dialogue with the timetabler, a file of pupils and their requests and allocations and a file containing details of the Option Scheme. Facilities are provided for viewing the scheme, the classes, the pupils and the class clash matrix.

**CRYPTO PACK £8** This is the complete kit for all those interested in cryptography, codes, ciphers and cryptanalysis. Developed by Dr Michael Richter, the package includes Cryptosub, General Cipher, Cryptanalyser and New Cipher programs.

\*Send for a free Data Sheet.

**PLUS**

### The Original Cassette Magazine for the Commodore PET... CURSOR

**CURSOR** — The cassette program magazine for PET owners. Mailed to you by first class post, each issue contains a dynamic graphic cover, table of contents and at least five new programs. There is a featured game which might cost £8 elsewhere, plus tutorials, programming aids and business routines, and of course CURSOR Notes with news and equipment reviews.

U.K. £36 for one year's subscription (10 issues)

Overseas airmail £45 for one year

Send for a free Data Sheet

**AND**

### PETSOF T PROGRAMMERS TOOLKIT

"10 Powerful New Commands for your PET!"

The Toolkit is a machine language program which is provided in a 2 kilobyte ROM chip. Just plug it in — no tools are necessary — and your PET's BASIC has 10 new and very useful commands including:

AUTO RENUMBER, DELETE, FIND, APPEND, DUMP, HELP, TRACE and STEP.

For the new 16K and 32K PETs, the toolkit consists of a single ROM chip which plugs into the left most empty socket inside the PET. Price £55 plus VAT. For 8K and other old ROM PETs a small printed circuit board is attached to the memory expansion and 2nd cassette ports of the PET. Price £75 plus VAT. Send for a free Data Sheet.

Recommended by Commodore

Programs are available on Commodore format cassettes. Some titles are available on disk for ACT PETSOF T and Commodore Disk systems. PET is the trade mark of Commodore

# act Petsoft

Radclyffe House, 66-68 Hagley Road, Edgbaston, Birmingham B16 8PF. Telephone: 021-455 8585 Telex: 339396



Please send me a copy of your latest catalogue

My name is \_\_\_\_\_

I live at \_\_\_\_\_

Postcode \_\_\_\_\_

I have a new/old ROM PET

I have NO PET

• Circle No. 152

**£1 a day keeps  
your Apple in play**

**A 48K Apple II  
microcomputer  
will cost you less  
than £1 per day  
under our lease  
or lease/purchase  
facilities**



£28.84 per month for 48K Apple II.

## Software not Soft Talk

During the last 18 months many Accountants have profitably used Padmede's Disc-Based Incomplete Record Accounting System. Many unique features are included e.g. analysis by Nominal Ledger and Account Codes, input direct from bank statement, selective code reporting, multiple runs of final accounts, etc. Hardware and software price £4,250.

Other software developed and installed with users includes:—

- Time and Cost Recording.**
- Stock Control.**
- Payroll.**
- Job Costing.**
- Order Processing.**
- Sales Ledger**
- Word Processing**

For more information contact:—  
Padmede Ltd., The Tuns, High Street,  
Odiham, Nr. Basingstoke, Hants.  
Tel. Odiham (025-671) 2434.

• Circle No. 153

NorthStar 

COMPATIBLE HARDWARE

	£Kit	£Ass.
NORTHSTAR		
Horizon-0-Ok	475	650
Horizon-1-16K-D	995	1265
Horizon-1-32K-D	1125	1445
Horizon-2-16K-D	1245	1575
Horizon-2-32K-D	1375	1755
Z80A CPU card	145	175
Hardware Floating Point card	195	215
Set of 4 ECs and card guides	15	30
Parallel Port	29	45
Serial Port	29	45
Dual density controller with Rel. 5 S/W	225	275
16K dynamic memory card	225	275
32K dynamic memory card with parity features	375	425

#### OTHER MANUFACTURERS

Morrow SwitchBoard I/O card (2P + 2S)	125	155
Heuristics 20S Speech recognition card	n/a	145
Heuristics 50 Speech recognition card	n/a	225
Solid State Music PROM card with textool	85	135
Morrow DISCUS 2D controller	POA	POA
Morrow DISCUS 2D system, includes 1 drive	n/a	POA

#### PERIPHERALS

Intertec Intertube II VDU (uses Z80 & 6K EPROM)	n/a	575
Elbit DS1920, model 30 VDU	n/a	730
Anadex DP-8000, 112 cps bi-directional printer	n/a	525
Optional 2K buffer for above	n/a	35
Digital Equipment LA36 DECwriter terminal	n/a	850
Digital Equipment LA34 terminal	n/a	825
NEC Spinwriter 55cps letter quality printer	n/a	1475

All prices given are exclusive of VAT (presently 15%) and carriage, and are correct at time of going to press. Educational and OEM terms are available on request. Please send 12p stamp for full details.

Telex: 925859

Telephone: 01-834 0261/2733

Interam Computer Systems Ltd.

59 Moreton St., Victoria,

London SW1

 INTERAM

• Circle No. 154

**COLOUR  
YOUR  
NASCOM!**



#### DAZZLING COLOUR GRAPHICS FOR NASCOM 1

Genuine bit-addressable "pixel" system for straight-forward programming of pictorial or mathematical functions.

8 Colour display plus 8 colour independent background facility. Full documentation with FREE SOFTWARE: powerful sub-routines for vector generation, demonstration program for animated effects. All runs in Nascom 1 without expansion. Complete with UHF Colour Modulator for operation with normal colour TV set. Superior design allows connection to most other micro-processor systems — send us diagrams etc of your b & w video circuitry for free advice. Don't be fooled by the price: this is a top quality product which will transform your computer.

NOW AVAILABLE FOR **£45** Inclusive of VAT and postage. LIMITED PERIOD AT

**WILLIAM  
STUART  
SYSTEMS Ltd**

Dower House, Billericay Road,

Herongate, Brentwood,

Essex CM13 3SD.

Telephone: Brentwood (0277) 810244



• Circle No. 155

# NEW LOW PRICE FOR LEVEL II BASIC 16K



## TRS-80 Microcomputer the world's biggest selling personal microcomputer

This is a fantastic opportunity to own a TRS-80 personal microcomputer. Designed and built by TANDY, the TRS-80 is the world's biggest seller, with over 100,000 in use. The 'silicon chip' revolution is here, now, at your nearest TANDY store. If necessary you simply add-on extra modules to suit your individual requirements. See a TRS-80 at your Local TANDY today.

- \* Level refers to version of BASIC computer language.
- \* 16K is size of Random Access Memory Capacity.
- \* All systems include 232 page users manual & games cassette program.
- \* No prior knowledge of computing is required to use the TRS-80.
- \* Fully wired and tested —NOT a kit.
- \* Designed and Manufactured by TANDY Corporation.

**£519** + VAT 26-1006

Total £596.85 Old price £752.81  
inc. VAT at 15%



**SAVE  
£155.96**

### TRS-80 Expansion is easy!—Just add the units to suit your needs.

	Old Price incl. 15% VAT	New Low Price (less VAT)	New Low Price incl. VAT	SAVE
26 1120 ROM	£84.12	£73	£83.95	
26 1101 16K Upgrade	£137.36	£105	£120.75	<b>£16.61</b>
26 1003 16K Level I	£668.69	£480	£552.00	<b>£116.69</b>
26 1004 4K Level II	£615.45	£448	£515.20	<b>£100.25</b>
26 1006 16K Level II	£752.81	£519	£596.85	<b>£155.96</b>
26 1140 Expansion Interface	£243.84	£199	£228.85	<b>£14.99</b>

Offers subject to availability. Instant credit available in most cases. Access, Barclaycard and Trustcard welcome. Check your telephone directory for your nearest store.

OVER 170 STORES AND DEALERSHIPS NATIONWIDE.

KNOWN AS RADIO SHACK IN THE U.S.A. MAKERS OF THE WORLD'S BIGGEST SELLING MICROCOMPUTER TRS80.

# TANDY

### BRINGING HIGH TECHNOLOGY DOWN TO EARTH

Please send full details and new low prices of TRS-80 systems.

NAME \_\_\_\_\_

ADDRESS \_\_\_\_\_

PHONE \_\_\_\_\_

TANDY CORPORATION, BILSTON ROAD, WEDNESBURY, W. MIDLANDS, WS10 7JN.

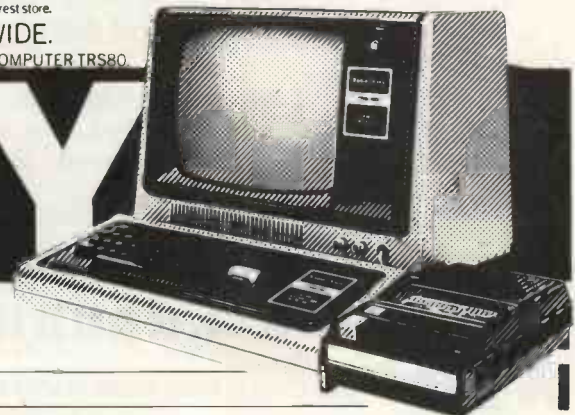

• Circle No. 156

# WE OFFER A COMPLETE SERVICE!

When you buy a computer from us — we don't give you the box and wave goodbye.

We realise this is a major purchase for a Company and take the time to find out your requirements, design your computer system and write the software, or if you prefer to write your own, we will always be available to advise you.

You can buy a wide range of fully-documented packages — Word Processing/Purchase & Sales Ledgers/ Stock Control/Incomplete Records/Medical Systems/Teaching Programs etc. on Microcomputers such as—

**APPLE II** from £810  
(16K)  
A complete business system 48K  
Apple, 2 Disk Drives, VDU &  
Printer £2,650

**MICROSTAR** from  
£4,950  
Multi-user/Multi-task  
1.2/2.4 or 4.8 mb.  
A complete system with 2 VDUs  
& Printer £7,000

**ALPHA MICRO** from  
£9,950  
From 1 to 32 terminals.  
From 10 mb. to 90 mb. disk  
storage.  
16-bit processor, Multi-user  
operating system.

**We stock a full range of VDUs, Printers,  
Computer Stationery, Diskettes, Disk Boxes etc.**

all prices ex VAT.

Come and see us to discuss your requirements and have a demonstration.

## MICROSOLVE

Microsolve Computer Services Ltd.  
125 /129 High Street, Edware, Middlesex.  
Tel: 01-951 0218

M1 junction 4 /20 mins from Central London.

e.g.  
**LOW COST  
PRINTERM**  
matrix printer £695  
**LEAR SEIGLER**  
200A matrix printer £1,650  
**QUME Sprint 5**  
daisywheel printer £2,115.

• Circle No. 157

# INNOVATIVE TRS-80 SOFTWARE

**NEW!!**

**INFINITE BASIC**

**NEW!!**

"Infinite Basic" adds over 70 new commands to your Level II or Disk Basic. Furthermore, these are modularised so that any combination may be loaded at any time, which makes the package very memory efficient. A sampling of the additions includes *complete* string functions, left & right justify, truncate, rotate, text justification, reverse strings, verify, string searches etc., etc. Complete Matrix functions are also included with inverse, transpose, simultaneous equations, multiply scalars, vectors; reshape, expand and delete arrays; change arrays in mid-program, zero and move arrays etc., etc.

"Infinite Business" is an add-on package to the above and includes multiple precision-packed decimal arithmetic, eliminating round-off errors with a 127-digit maximum accuracy. Also includes binary search of sorted arrays, automatic page headings and more!

Infinite Basic . . . £29.95. Infinite Business . . . £16.95. Both plus VAT & 50p p & p.

Send large SAE (12½p) for our current catalogue of TRS-80 Software.

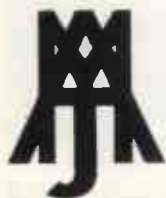

**A.J.HARDING (MOLIMERX)**

28 COLLINGTON AVENUE, BEXHILL-ON-SEA, E.SUSSEX.

TEL: (0424) 220391



• Circle No. 158

## DPS-1 MAINFRAME

Introducing the DPS-1 the full IEEE S100 bus computer system from Ithaca Intersystems — the S100 experts.

FOR EDUCATION, INDUSTRY, RESEARCH and all professional uses, including hardware and software development, low cost OEM systems, teaching applications etc.



A MINI COMPUTER using MICRO technology at a ridiculous MICRO Price!!! The front panel with a backplane and power supply accepts S100 bus boards from many manufacturers.

# InterSystems

Just look at these professional features!

★ FRONT PANEL (we won't ask you to debug our hardware, but we will give you the tools to debug yours!) Has lights and switches to allow inspection and control of addresses and data. Other features include programmed input switches, and output lights, Examine, Examine next, deposit, deposit next, single or slow step (0.1 to 1000 IPS), hardware breakpoint on any data or address byte, repeat instruction and many other hardware diagnostic facilities.

★ 30 Amp, 8V power supply, 5 Amps on  $\pm 16$ v rails (all rails are separately fused)

★ 20 slot IEEE S100 Motherboard with active termination and shielding between bus lines

★ Guaranteed operation at 4MHz.

The DPS1 comes as a mainframe with front panel, Motherboard, power supply and 4MHz Z80A cpu board. The system is truly modular allowing the user to build up the system he requires in his own time.

S100 boards from a number of manufacturers can plug into the DPS1 IEEE S100 bus.

Just add S100 Memory Boards — S100 disk controller boards — S100 I/O boards — S100 video and/or graphics boards — S100 EPROM boards

All Ithaca Intersystems OEM products including K2 disk operating system and PASCAL/Z on 8" floppy drives will run in the DPS-1.

DPS-1 with S100 4MHZ Z80 cpu board **£695**  
Fully assembled and tested

## SOFTWARE for your S100 system

### PASCAL/Z The new language for Micros

CP/M Version **£165.00**  
K2 Version **£131.25**

Runs under K2 operating system,

★ Compiler that produces Z80 macro assembler code — NO NEED for slow run time P-code interpreter. ★ Comes complete with Macro assembler. ★ Produces binary object modules — small and fast. ★ Modules are re-entrant and can be put into ROM. ★ IMBED, TRACE and ERROR debug facilities. ★ Recursion

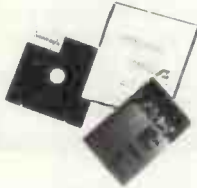

### K2 OPERATING SYSTEM **£56.25**

8" disk based operating system — distributed on Shugart compatible 8" floppy disk  
★ TED — 52 command character orientated text editor with macros. ★ PIP — File and directory handler. ★ ASMBLE — full Z80 2 pass assembler. ★ HDT — Hex debug tool. ★ OCI — Utility overlay/command decoder. ★ SYSGEN — System builder. ★ COPY — disk to disk file copier. ★ DUP — disk duplicator.

### ASMBLE/Z Z80 Macro assembler **£37.50**

★ Full 2 pass Macro Assembler. ★ IF and ELSE — 255 nesting levels. ★ Produces symbol table. ★ Relative jumps.

## OEM S100 boards from the experts!



New products from Ithaca audio!

Assembled and tested

Disk controller (up to 4 single or double sided drives) **£131.25**  
I/O board (4 parallel and 2 serial ports) with interrupts **£210.00**  
I/O board (4 parallel and 2 serial ports) less interrupts **£180.00**  
S100 front panel (as used in DPS1) **£245.00**  
Analogue I/O board **£295.00**

Assembled and tested

8K Static RAM board (450ns)	£123.75
8K Static RAM board (250ns)	£146.25
16K Static RAM board (450ns)	£216.00
16K Static RAM board (250ns)	£234.00
64K Dynamic RAM board (250ns)	£540.00
Z80 cpu board (2MHz)	£131.25
Z80 cpu board (4MHz)	£153.75
2708/2716 EPROM board	£63.75
Prototype board (bare board)	£18.75
Video display board (64x16, 128UL Ascii)	£108.75

AVAILABLE SOON: ZBC-1 Single board computer for OEM market. Available in basic through to fully expanded. 4MHz Z80A, 64K RAM, memory mapped 4K screen buffer, composite video, up to 16K power on EPROM monitor, 4 parallel ports, 2 serial ports, 4 channel counter timer. 1 off **£895** — please phone for a quote for your needs. (quantity discounts available).

ALL MANUALS AVAILABLE SEPERATELY **£2.50** each

## PASCAL MICRO DEVELOPMENT SYSTEM

*Are you still waiting for one?*

ITHACA Intersystems HAVE JUST ANNOUNCED AN IEEE S100 SYSTEM WITH A TRUE PASCAL COMPILER

FOR RESEARCH and DEVELOPMENT LABORATORIES and TEACHING APPLICATIONS

### The PASCAL System



- DPS1 Mainframe with hardware front panel.
- Z80A 4MHZ Microprocessor.
- 64K Static RAM.
- 8" Shugart Floppy Disc Drive, Power Supply and Controller.
- K2 DOS Operating System.
- Pascal Compiler and Macro Assembler.
- I/O Board with RS232 port and parallel port

*While the others are talking about it, we are delivering!*

### CONTACT THESE UK DEALERS

All prices quoted are exclusive of VAT.

NEWBEAR COMPUTING STORE (Newbury) (0635) 30505 Telex: 848507 SIRTON PRODUCTS (Surrey) 01-660 5617  
DATAVIEW LTD. (Colchester) (0206) 78811 TRANSAM (C.London) 01-402 8137 Telex: 444198  
CODIFIED COMPUTER SYSTEMS (North London) 01-226 1319 MICRONEX (Bristol) (027589) 3042

ITHACA Intersystems  
(formerly ITHACA AUDIO of New York)

### EUROPEAN SUBSIDIARY

58 Crouch Hall Road, London N8 8HG. England.  
Telephone: 01-341 2447 Telex: 895 4665 - Ref: ITHACA

• Circle No. 159

# Bad Cloud?

If you encounter persistent program loading problems in spite of cleaning the record/playback head, and experimenting with volume and tone control settings, it could be that the azimuth adjustment is incorrect. This is the case on a surprising number of machines, even when first supplied.

The azimuth adjustment alters the angle of the record/playback head, and the correct setting is precisely perpendicular to the motion of the tape. If it is incorrect, the high frequencies suffer drastic attenuation, which is the reason for many program loading failures, particularly with pre-recorded tapes which were not made on the same machine.

The adjustment may be easily made on most machines with the aid of our special high frequency test tape. Instruction sheet supplied.

**PRICE** \_\_\_\_\_ **£4.60 inc. VAT and postage**  
Callers by appointment only please.

**Alan Ford + Company**  
PHOENICE HOUSE, GREAT BOOKHAM, SURREY

• Circle No. 160

# Sigma Technical Press

the UK software publisher

**NEW** — from SIGMA for NASCOM: Z80 INSTANT PROGRAMS : Machine code routines for NASCOM-1 and other Z80 systems by J. Hopton (G3WMP).

36 fully tested programs from delays through displays to games for the simplest NASCOM-1 or similar Z80 systems. Test your system and build your confidence!  
Book £7.50 Complete NASCOM - 1 Cassette £10.00

**AND** - our catalogue of books and software is one of the best in the UK. Ask for your copy or start by ordering these:

Computer Programs That Work! (24 BASIC Programs)	£3.15
Consumers Guide to Personal Computing & Micro's	£5.30
Basic BASIC : an Introduction to Programming	£5.90
Game Playing with BASIC	£4.70
How to build a Computer Controlled Robot	£5.30
The Mind Appliance : Home Computer Applications	£4.70
BASIC with Style : Programming Proverbs	£4.10
Microprocessor Basics (w/ldc survèy)	£7.10
Microprocessor Data Manual (30 sources)	£5.30
Microprocessors : New Directions for Designers	£7.10
How to Profit from your Personal Computer	£5.30
The Systems Analyst: How to Design Systems	£7.10

Prices include postage & packing in Europe and VAT where applicable. Official orders accepted from UK only for orders over £5.00. Outside UK, payment required in advance in Sterling on UK bank.

Sigma Technical Press; FREEPOST, 23 Dippons Mill Close, Tettenhall Wood, Wolverhampton WV6 7BR.

• Circle No. 161

# AIM 65 £249.50 + VAT

## FEATURES INCLUDE:

- \* 20 COLUMN PRINTER.
  - \* 20 CHARACTER ALPHANUMERIC DISPLAY
  - \* FULL 54 KEY TERMINAL-STYLE KEYBOARD
  - \* TTY INTERFACE
  - \* TWIN CASSETTE INTERFACE
  - \* RAM — 1K TO 4K OPTIONS
- OPTIONAL EXTRAS INCLUDE:**
- 8K 'BASIC' INTERPRETER ROM

— £70.00  
4K ASSEMBLER ROM — £59.50  
POWER SUPPLY — £41.83  
CASE (Including Power Supply) — £78.00

**EXPANSION MOTHERCARD**  
— £136.50

AIM 65 comes to you fully built and tested with a full alphanumeric keyboard, 20 character display and a 20 column printer — for keeping a permanent record of all your work. Available in 1K- and 4K-byte RAM versions, AIM 65 is designed around the 6502 CPU, which has 64K address capability with 13 addressing modes. This is the microprocessor at the heart of many other, more costly, systems such as PET and APPLE.

AIM 65 has a 4K-ROM-resident monitor program for all peripheral control and user programming functions. Spare sockets are included for expanding on-board program memory via user PROM-based programs and/or Rockwell assembler, text editor and BASIC interpreter plug-in options. AIM 65 has a connector for external access to system bus for memory and

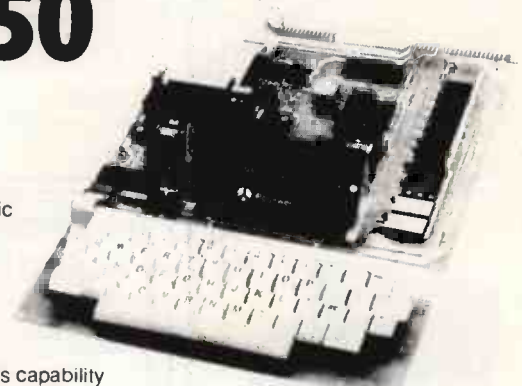

I/O expansion, a separate connector for interfacing a teletype and two cassette recorders. There is a user-dedicated Versatile Interface Adaptor, featuring three 8-bit, bidirectional ports (two parallel, one serial) and two 16-bit interval timer/event counters — thus allowing the user to interface his own system, without extra interface devices in many cases. AIM 65 is probably the most effective, low-cost microcomputer development system available — an invaluable educational aid to first time users and an ideal general purpose micro-computer for the engineer.

AIM 65 is available in the UK from PELCO ELECTRONICS LTD at £249.50 + VAT, complete with User's Manual and Schematic, R6500 Programming and Hardware Manuals and a handy pocket reference card.

• Circle No. 162

## Pelco (Electronics) Ltd

Enterprise House 83/85 Western Road HOVE East Sussex BN3 1JB  
Tel: Brighton (0273) 722155

Buy it with your Access or Barclaycard.



# NASCOM-2

## Our nomination for the best microcomputer board in the world.

In about the same area as this advertisement, we have designed a microcomputer with 20K of addressable memory ON-BOARD. With Kansas City standard cassette interface ON-BOARD. With TV/monitor interface ON-BOARD. With control decoding ON-BOARD. With all bus lines fully buffered ON-BOARD.

We call this microcomputer **Nascom-2**. And for under £300 this is what it has:

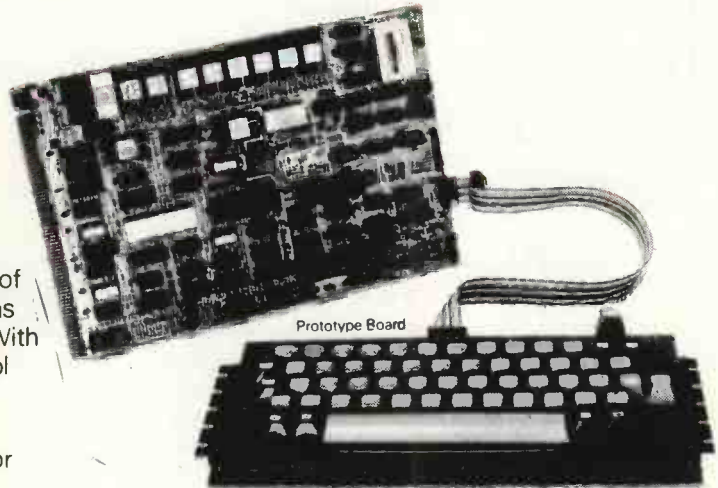

### Microprocessor

Z80A. 8 bit CPU. This will run at 4 MHz but is selectable between 1/2/4 MHz.

This CPU has now been generally accepted as the most powerful, 8 bit processor on the market.

The software library for the Z80, with its base around the 8080, has rapidly expanded with the increasing use of its more powerful instruction set.

### Hardware

12" x 8" Card

All bus lines are to the Nasbus specification.

All bus lines are fully buffered.

PSU +12v, +5v, -12v, -5v.

### Memory

On-board, addressable memory:-

- 2K Monitor - Nas-Sys I (2K ROM)
- 1K Video RAM (MK4118)
- 1K Work space/User RAM (MK4118)
- 8K Microsoft Basic (MK36000 ROM)
- 8K Static RAM/2708 EPROM

### INTERFACE

#### Keyboard

New expanded 57 key Licon solid state keyboard especially built for Nascom. Uses standard Nascom, monitor controlled, decoding.

#### T.V.

The 1v peak to peak video signal can drive a monitor directly and is also fed to the on-board modulator to drive the domestic TV.

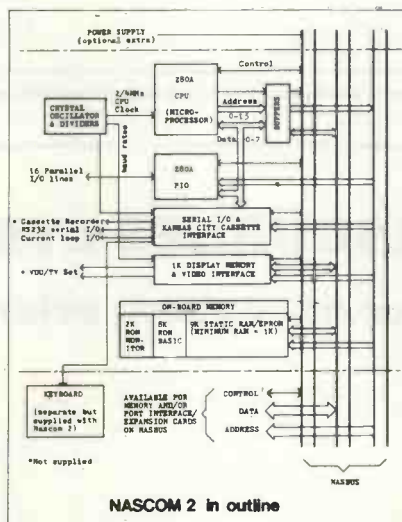

### I/O

On-board UART (Int 6402) which provides serial handling for the on-board cassette interface or the RS232/20mA teletype interface.

The cassette interface is Kansas City standard at either 300 or 1200 baud. This is a link option on the NASCOM-2.

The RS232 and 20mA loop connector will interface directly into any standard teletype.

The input and output sides of the UART are independently switchable between any of

the options - i.e. it is possible to use input on the cassette and output on the printer.

### PIO

There is also a totally uncommitted Parallel I/O (MK3881) giving 16, programmable, I/O lines. These are addressable as 2x8 bit ports with complete handshake controls.

### On-board Decoding

The NASCOM-2 makes extensive use of ROMs for on-board control decoding. This reduces the chip count and allows easy changes for specialised industrial use of the board.

Link options are on-board to allow the Reset control to be reassigned to an address other than zero.

### Character Generators

The 1K video RAM drives a 2K ROM character generator providing the standard ASCII character set with some additions, 128 characters in all. There is also a socket for an optional graphics ROM on-board.

The PCB is, of course, of industrial standard, through hole plated, masked and screen printed.

### Documentation

Full construction article is provided for those who buy a kit and an extensive software manual is provided for the monitor and Basic.

We think no other board has quite so much on it for £295 (plus VAT).



Nascom Microcomputers

121 High Street Berkhamsted Herts.  
(04427) 74343

• Circle No. 163

# tridata + MICROS = SOFTWARE

Business systems available now for the TRS 80

Sales Ledger (OPEN ITEM/DEBTORS ANALYSIS/STATEMENTS/INVOICES/VAT/DAYBOOKS etc.) from £150

Purchase Ledger (OPEN ITEM/CREDITORS ANALYSIS/REMITTANCE ADVICE/VAT/DAYBOOK etc.) from £150

Invoicing (UPDATES SALES LEDGER/DOWNDATES STOCK/MAINTAINS BACK ORDERS) £75

Stock Control (ISSUES/RECEIPTS/MOVEMENT, USAGE, VALUATION, RE-ORDER REPORTS etc.) £200

Payroll (WEEKLY, MONTHLY, CASUAL STAFF/BONUS SCHEMES/COIN ANALYSIS/PAYSLIPS etc.) £200

Nominal Ledger (Available shortly)

12 MONTH WARRANTY ON ALL PACKAGES - TAILORED SYSTEMS TO YOUR REQUIREMENTS

FOR THE BEST IN PROFESSIONAL MICRO BUSINESS SOFTWARE CONTACT US DIRECT OR CALL YOUR NEAREST TRIDATA DEALER FOR A DEMONSTRATION.

CAMBRIDGE COMPUTER STORE (CAMBRIDGE)	0223 68155
COMPUTER DEVELOPMENT SERVICES (SWANSEA)	0792 26085
ELECTRON SYSTEMS (SANDY, BEDS.)	0767 81195
A. J. HARDING (BEXHILL, E. SUSSEX)	0424 220391
KATANNA MANAGEMENT SERVICES (CHELMSFORD)	0245 76127
OPTRONICS (TWICKENHAM)	01 892 8455
DATASOURCE COMPUTER SERVICES (PORTSMOUTH)	0705 816991/8
GPW ELECTRONICS LTD (PORTSMOUTH)	0705 693341

Tridata Micros Ltd.  
Smithfield House  
Digbeth  
Birmingham B5 6BS  
Tel: 021 622 1754

• Circle No. 164

## RESEARCH RESOURCES LTD.

Microcomputers for education, science and technology



- PET, Vector and SWTP
- Fortran, Pascal, Cobol, CBasic, Multi-user PILOT
- Exclusive to RRL: Lab-Basic, SAM (Statistical analysis) A-to-D, D-to-A converters.
- Showrooms at 40, Stonehills, Welwyn Garden City, Herts. Tel: Welwyn Garden 26633 (24 hours).

• Circle No. 165



# TRANSAM COMPUTER PRODUCTS

## TRITON SINGLE BOARD PERSONAL COMPUTER

THREE NEW EXCITING EXPANDABLE SYSTEMS DESIGNED FOR EASE OF CONSTRUCTION AND FLEXIBILITY. KITS COME COMPLETE WITH CASE, POWER SUPPLY, FULL KEYBOARD, PCB. ALL COMPONENTS AVAILABLE SEPARATELY SEE CATALOGUE.



FULL HARDWARE AND PROGRAMMING MANUAL AVAILABLE. THE SYSTEM IS EASY TO EXPAND AND IS WELL SUPPORTED. FEATURES 2, 2.5 OR 7K BASIC IN EPROM (SEE CATALOGUE).

- SINGLE BOARD
- HOLDS UP TO 8K MEMORY
- VHF OR VIDEO OUTPUT
- CASSETTE INTERFACE
- THREE FIRMWARE OPTIONS
- BASIC IN EPROM
- 64 GRAPHICS CHARACTERS
- PLUS IN EXPANSION BOARDS

**Personal Computer £286 +VAT FROM**

## EXPANSION MOTHERBOARD

TRITON. Expand your Triton simply and easily with our new 8-slot motherboard; complete with its own P.S.U. takes 8 plug-in Euro cards. Plug-in 8K RAM card.

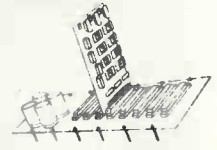

**£50 + VAT**

AND EPROM CARDS NOW AVAILABLE. KIT COMPLETE WITH PSU-1 SET CONNECTORS

## 8K RAM CARD

TRITON 8K STATIC RAM CARD KIT USES 2114 LOW-POWER 4V STATIC RAMS. ON-BOARD REGULATION. NEW JUMP SELECT PCB ONLY £5. RAMS £5.50 KIT LESS RAMS £35 INCL 5KTS COMPONENTS

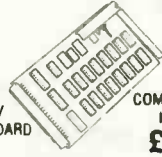

COMPLETE KIT **£97 + VAT**

## 8K EPROM CARD

TRITON 8K EPROM CARD KIT DESIGNED TO TAKE UP TO 8 x 2708 EPROMS (1K x 8) PCB ONLY £15 KIT LESS EPROMS £31 EPROMS (BLANK) £9 PLUS VAT



**£97 + VAT**

COMPLETE KIT + VAT

## BI-DIRECTIONAL MATRIX PRINTER £595 + VAT

THE BD80 IS A LOW-COST, 80-COLUMN LINE PRINTER WITH MICROPROCESSOR CONTROL TO PROVIDE EXCELLENT AVAILABILITY AND PERFORMANCE.

- 5 x 7 Dot Matrix
- 10 Char. per inch
- 6 Lines/inch
- 400 Char. Buffer
- Full ASCII Char. Set
- Self Test
- 10 Lines/sec Paper Advance
- 112 Char./sec
- 82 Lines per minute
- Fully Cased

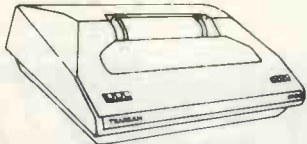

A UNIQUE PRINTER FAST AND RELIABLE

SWITCH-SELECTABLE BAUD RATE FROM 110 TO 9,600 ON A STANDARD V24 AND RS232 INTERFACE. SEND SAE FOR FURTHER DETAILS. IDEAL PRINTER FOR TRITON OR ANY SYSTEM REQUIRING HIGH-SPEED, RELIABLE HARD COPY. WE CAN SUPPLY CONSUMABLES.

## \$100 BOARDS

8K Static RAM board (450ns) £123.75  
8K Static RAM board (250ns) £146.25  
Z80 cpu board (2MHz) £131.25  
Z80 cpu board (4MHz) £153.75  
2708/2716 EPROM board £63.75  
Prototype board (bare board)  
Video display board (64 x 16, 128U/L Ascii) £108.75  
Disk controller board £131.25  
K2 disk operating system £56.25  
Assemble/ZMacro Assm £37.50

## ITHACA Pascal/Z

build your own Pascal Micro Development system. IEEE-SIDO bus system using DPSI mainframe. Supports K2, assemble/Z and Pascal/Z on 8in disk.



your London dealer!

We stock the full range of ITHACA products.

## PCB CONNECTORS

EDGE CONNECTORS GOLD CONTACT DOUBLE-SIDED PCB CONNECTORS

1 in.	PRICE	156 in.	PRICE
22/44	£3.20	6/12	1.25
25/50	£3.60	10/20	1.50
28/56	£3.90	12/24	2.00
30/60	£4.15	15/30	2.20
35/70	£4.60	18/36	2.30
36/72	£4.75	22/44	2.65
40/80	£5.00	28/56	3.30
43/86	£5.50	36/72	3.90
50/100	£5.80	43/82	£4.60 +VAT

## TRAP! Triton resident assembly language package.

Links via the L6.1 monitor and new scientific basic to make Triton a stand alone development system. Trap is an 8K package in EPROM and resides on our EPROM card. Set of 8 x 2708 only £80 including document.

- EDITOR
- DISASSEMBLER
- ASSEMBLER
- SYMBOL TABLE
- CREATE
- BREAKPOINT
- SINGLE STEP
- TRACE
- PROGRAM LOAD
- MONITOR

See catalogue for further details.

## COMPONENTS 74LSXX

SN74LS00N	18	SN74LS54N	21	SN74LS138N	75	SN74LS195AN	85	SN74LS325N	255
SN74LS01N	18	SN74LS55N	21	SN74LS139N	75	SN74LS196N	120	SN74LS326N	255
SN74LS02N	20	SN74LS561N	150	SN74LS145N	120	SN74LS197N	120	SN74LS327N	255
SN74LS03N	18	SN74LS573N	35	SN74LS148N	175	SN74LS221N	125	SN74LS352N	135
SN74LS04N	20	SN74LS574N	40	SN74LS151N	85	SN74LS240N	220	SN74LS353N	150
SN74LS05N	26	SN74LS575N	46	SN74LS153N	60	SN74LS241N	190	SN74LS365N	65
SN74LS08N	20	SN74LS576N	35	SN74LS154N	160	SN74LS242N	190	SN74LS366N	65
SN74LS09N	22	SN74LS578N	35	SN74LS155N	125	SN74LS243N	195	SN74LS367N	65
SN74LS10N	18	SN74LS581AN	115	SN74LS156N	125	SN74LS244N	210	SN74LS368N	65
SN74LS11N	26	SN74LS585N	110	SN74LS157N	50	SN74LS245N	260	SN74LS373N	175
SN74LS12N	25	SN74LS586N	40	SN74LS158N	99	SN74LS247N	125	SN74LS374N	170
SN74LS13N	55	SN74LS590N	65	SN74LS160N	115	SN74LS248N	135	SN74LS375N	72
SN74LS14N	89	SN74LS591N	99	SN74LS161N	115	SN74LS249N	130	SN74LS377N	175
SN74LS15N	25	SN74LS592N	90	SN74LS162N	115	SN74LS273N	145	SN74LS378N	132
SN74LS20N	20	SN74LS593BN	65	SN74LS163N	90	SN74LS253N	125	SN74LS379N	140
SN74LS21N	26	SN74LS595AN	120	SN74LS164N	150	SN74LS254N	140	SN74LS381N	365
SN74LS22N	26	SN74LS596N	175	SN74LS165N	170	SN74LS255N	95	SN74LS386N	57
SN74LS26N	29	SN74LS107N	39	SN74LS166N	175	SN74LS259N	145	SN74LS390N	198
SN74LS27N	35	SN74LS109N	39	SN74LS168N	195	SN74LS260N	39	SN74LS393N	150
SN74LS28N	35	SN74LS112N	39	SN74LS169N	195	SN74LS261N	350	SN74LS395N	180
SN74LS29N	25	SN74LS113N	44	SN74LS170N	250	SN74LS262N	39	SN74LS396N	170
SN74LS32N	27	SN74LS114N	44	SN74LS172N	220	SN74LS273N	185	SN74LS398N	275
SN74LS33N	39	SN74LS122N	79	SN74LS174N	115	SN74LS279N	79	SN74LS399N	160
SN74LS37N	29	SN74LS123N	90	SN74LS175N	105	SN74LS280N	175	SN74LS424N	450
SN74LS38N	29	SN74LS124N	150	SN74LS181N	125	SN74LS283N	180	SN74LS445N	125
SN74LS40N	25	SN74LS125N	65	SN74LS190N	175	SN74LS290N	180	SN74LS447N	125
SN74LS42N	79	SN74LS126N	65	SN74LS191N	175	SN74LS293N	180	SN74LS480N	195
SN74LS47N	95	SN74LS132N	75	SN74LS192N	145	SN74LS295AN	220	SN74LS466N	95
SN74LS48N	95	SN74LS133N	39	SN74LS193N	175	SN74LS298N	220	SN74LS468N	95
SN74LS49N	109	SN74LS136N	40	SN74LS194AN	189	SN74LS324N	180	SN74LS467N	270

## TRITON DOCUMENTATION

available separately as follows, prices include p & p  
Triton manual — detailed circuit description and constructional details + user documentation on level 4.1 monitor & basic £5.70  
L4.1 listing — listing of 1K monitor & 2K tiny basic £4.20  
L5.1 user documentation on level 5.1 firmware £1.20  
L5.1 listing — listing of 1.5K monitor & 2.5K basic £5.20  
L6.1 user documentation on 7K basic interpreter £1.80  
Motherboard, 8K RAM & 8K EPROM constructional details SAE  
User group newsletter subscription £4 per annum  
Triton software — Send SAE for list of programs available for Triton.

## HOME COMPUTING CATALOGUE

If you're in town, visit our showroom in Chapel Street, next to Edgware Road tube station. We have Tritons on display plus a comprehensive range of components and accessories, specifically for personal computer users. Books, mags, tapes, data, cables plus much more. Showroom open 6 days a week. (Half day Thurs from 1.30 pm)



NEW A4 SIZE CATALOGUE FILLED WITH OUR LATEST PRODUCTS 40p+ SAE ALL PRICES EXCLUDE VAT

# TRANSAM



# VAT

ALL PRICES EXCLUDE VAT

TRANSAM COMPONENTS LTD. 12 CHAPEL STREET, LONDON, NW1 TEL: 402 8137

• Circle No. 166

A personal computer that  
opens the world of programming  
to your own fresh ideas!



SHARP MZ-80K

**78 Keys**

ASCII standard  
Alphabet (capital and small letters)  
Graphic symbols

**CRT Display**

This unit is equipped with a 25 cm (10") monochrome CRT for up to 1,000 letters (40 letters x 25 lines). Processing results can be displayed on the CRT and it is possible to program and edit (addition, deletion, etc.) while watching the operation for confirmation.

**Built-In Clock and Sound Circuits**

Clock circuit: time is displayed according to program  
Sound circuit: 3-octave sound signals for aural confirmation according to program

**Options**

- RAM 16K bytes
- 4K bytes
- Machine Language tape
- Assembler, Editor, Loader and Debugger
- (The above will be available in due course)

AVAILABLE FROM

**HB COMPUTERS LTD**

22 NEWLAND STREET, KETTERING NORTHANTS.  
Tel. (0536) 83922 & 520910 Telex 341297

• Circle No. 167

**WE MEAN BUSINESS**

Complete teak-mounted business systems  
ready to go  
(With software, stationery and staff tuition).

Leasing and deferred terms available.

All Commodore hardware and compatible  
peripherals stocked

Professional Business Software by 'Petact',  
'Petsoft', 'Gemsoft', 'Computastore' and  
'Grama (Winter)' at attractive prices.

Plus our own Professional Software  
for the Commodore PET.

Our best seller — "T.V. Rentals"  
(May be used for any equipment rental) —  
£80 plus vat.

39 ALBERT ST. KIRKWALL. KW15 1HQ.  
Phone (0856) 3140.

**Thistle Computers**

39 Albert St., Kirkwall KW15 1HQ.  
Phone (0856) 3140.

• Circle No. 168



**NewBear Books**



**NEWBEAR MAIL ORDER:** 40 Bartholomew Street, Newbury, Berks. Tel: 0635 30505

**NORTHERN SHOWROOM:** 220-222 Stockport Road, Cheadle Heath, Stockport Tel: 061 491 2290

**NEW BOOKS**

Microprocessors & Microcomputers	Huggins	£ 4.95
Computers & Commonsense	Hunt & Shelley	£ 3.50
Business Data Systems	Clifton	£ 5.75
Finance for the Small Business	R. Ragan	£ 7.20
The Best of Computer Faires Vol. 3		£ 9.50
Reducing COBOL Complexity through Structured Programming	McClure	£11.30
Microprocessor and Microcomputer Systems	Rao	£19.85
Encyclopedia of Computer Science Computer Approach to	Ralston	£48.60
Introductory College Maths.	Scalzo	£11.30
Microcomputer Handbook	Sippl	£16.15
Data Communications Dictionary	Sippl	£16.15
Handbook of APL Programming	Weidmann	£ 6.50
Computer Output Design	Wooldridge	£ 9.70
Computer Input Design	Wooldridge	£ 8.85

**INTRODUCTORY BOOKS**

Vol. 0 The Beginners Book	A. Osbourne	£ 5.95
Vol. I Basic Concepts	A. Osbourne	£ 5.95
Vol. II Some Real Products	A. Osbourne	£18.95
Vol. III Some Real Support Devices	A. Osbourne	£11.95
A Consumers Guide to Personal Computing		£ 5.65

**BASIC**

Basic Basic	J. S. Coan	£ 5.00
Advanced Basic	J. S. Coan	£ 5.50
Illustrated Basic	D. Alcock	£ 2.25
Basic with Business Applications		£ 5.56
The Users Guide to North Star Basic	Rogers	£10.00
Basic and the Personal Computer	Dwyer	£10.36

**MISCELLANEOUS**

Microprocessors C201	R. Zaks	£ 7.50
Interfacing Techniques C207	R. Zaks	£ 7.50
Best of Byte		£ 8.50
Scelbi Byte Primer		£ 9.95
A Dictionary of Microcomputing	P. Burton	£ 0.00
Small Computer Systems Handbook		£ 5.10
The Cheap Video Cookbook	Lancaster	£ 5.10
TV Typewriter Cookbook	Lancaster	£ 7.50
Active Filter Cookbook	Lancaster	£ 7.50

**PROGRAMMING**

Top-Down Structured Programming Techniques		£12.76
Assembly Level Programming for Small Computers	Weller	£12.76
How to Programme Microcomputers	Barden	£ 6.95
6800 Programming for Logic Design	A. Osbourne	£ 5.95
8080 Programming for Logic Design	A. Osbourne	£ 5.95
8080 Assembly Language Programming	A. Osbourne	£ 6.95
6800 Assembly Language Programming	A. Osbourne	£ 6.95

**GAMES**

32 Basic Programs for the Pet		£ 9.95
Chess & Computer	D. Levy	£ 7.16
Chess Skill in Man & Machine	P. Frey	£11.84
Basic Computer Games	AHL	£ 5.50
Game Playing with Computers	D. Spencer	£10.20
Game Playing with Basic	D. Spencer	£ 4.10

**Terms:** ALL BOOKS ADVERTISED ARE IN STOCK AT TIME  
OF PRINTING. OFFICIAL ORDERS (MIN £10), ACCESS &  
BARCLAYCARD WELCOME.

SEND FOR COMPLETE BOOK & MAGAZINE LIST.

• Circle No. 169

# Why wait for a kit computer when you can buy a fully built & tested Superboard III off the shelf?

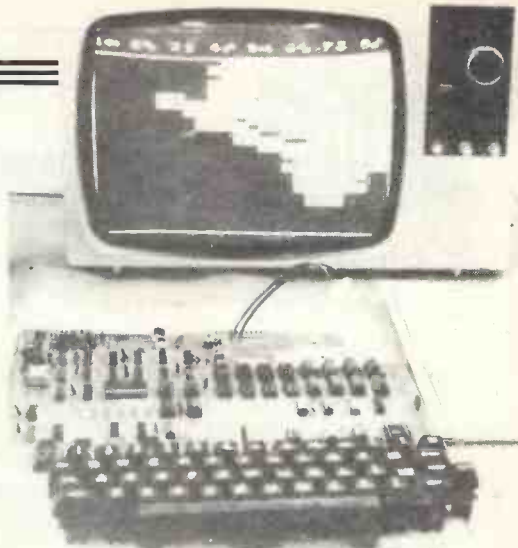

Ohio Scientifics

## SUPERBOARD III

Now only **£188** + VAT

Full 8K basic and 4K user RAM Built and tested  
Power supply and R.F. Converter P.O.A.

We are passing on our savings from the rise in the £  
(Delivery within 7 days)

The machine can be economically expanded to assist in your business, remotely control your home, communicate with other computers and perform many of the tasks via the broadest lines of expansion accessories in the microcomputer industry. This machine is super easy to use because it communicates naturally in BASIC, an English-like programming language. So you can easily

instruct it or program it to do whatever you want, but you don't have to. You don't because it comes with a complete software library on cassette including programmes for each application stated above. Ohio Scientific also offers you hundreds of inexpensive programs on read-to-run cassettes. Program it yourself or just enjoy it, the choice is yours.

### Features

- Uses the ultra powerful 6502 microprocessor
- 8K Microsoft BASIC-in-ROM
- Full feature BASIC runs faster than currently available personal computers and all 8080-based business computers.
- 4K static RAM on board expandable to 8K
- Full 53-key keyboard with upper-lower case and user programmability
- Kansas City standard audio cassette interface for high reliability
- Full machine code monitor and I/O utilities in ROM
- Direct access video display has 1K of dedicated memory (besides 4K user memory), features uppercase, lower case, graphics and gaming characters for an effective screen resolution of up to 256 by 256 points. Normal TV's with overscan display about 24 rows of 24 characters, without overscan up to 30 x 30 characters.

### Extras

- Available expander board features 24K static RAM (additional mini-floppy interface, port adapter for printer and modem and OSI 48 line expansion interface.
- Assembler/editor and extended machine code monitor available.

### Commands

CONT	LIST	NEW	NULL	RUN		
Statements						
CLEAR	DATA	DEF	DIM	END	FOR	
GOTO	GOSUB	IF...GOTO	IF...THEN	INPUT	LET	
NEXT	ON...GOTO	ON...GOSUB	POKE	PRINT	READ	
REM	RESTORE	RETURN	STOP			

### Expressions

#### Operators

-, +, \*, /, ↑, NOT, AND, OR, >, <, <>, >=, <=, =  
RANGE 10<sup>-32</sup> to 10<sup>+32</sup>

### Functions

ABS(X)	ATN(X)	COS(X)	EXP(X)	FRE(X)	INT(X)
LOG(X)	PEEK(I)	POS(I)	RND(X)	SGN(X)	SIN(X)
SPC(I)	SQR(X)	TAB(I)	TAN(X)	USR(I)	

### String Functions

ASC(X\$)	CHR\$(I)	FRE(X\$)	LEFT\$(X\$,I)	LEN(X\$)	MID\$(X\$,I,J)
					VAL(X\$)
				STR\$(X)	

Plus variables, arrays and editing facilities.

Fully built and tested. Requires only +5V at 3 amps and a videomonitor or TV and RF converter to be up and running.

## What the magazines say

"The Superboard represents good value with plenty of potential"  
Practical Computing June '79

"Certainly one of the most exciting (computers) on the present market"  
Practical Electronics June '79

"A useful machine.....represents value for money"  
Computing Today June '79

Dealer Enquiries welcome at Morgan St. address

Watford Electronics  
33/35, Cardiff Road,  
Watford, Herts.  
Tel: Watford 40588/9

Videotime Products  
56, Queens Road,  
Basingstoke, Hants RG21 1REA  
Tel: 0256 56417

Lotus Sound  
4, Morgan Street,  
London E3 5AB  
Tel: 01-981 3993

• Circle No. 170

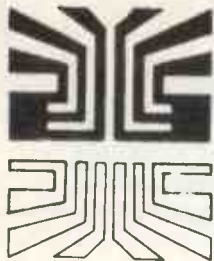

# Small Systems Engineering Limited

62 NEW CAVENDISH STREET, LONDON W1M 7LD  
TELEPHONE: 01-637 0777. Telex: 8813085 ABACUS

SUPPLIERS OF PET MEMORY BOARDS AND INTERFACES THROUGHOUT EUROPE  
COMMODORE APPROVED

### \* NEW CUSTOM CHIP INTERFACES

- \* Custom chips allow any character codes
- \* Option to print U/L case as PET Screen
- \* Parallel versions for PR40, ANADEx, CENTRONICS etc
- \* Fully addressable for PET Disc compatibility
- \* Custom Character Sets — One week delivery
- \* Parallel . . . . £106 Serial . . . . £120

### PET INTELLIGENT TERMINAL SOFTWARE PACKAGE

A software package which, in conjunction with an interface B enables the PET to operate as an intelligent terminal. £100

### TV/VIDEO MONITOR INTERFACE

— Video and UHF output (plugs into TV aerial socket) £35

### IEEE 488/CENTRONICS TYPE PARALLEL INTERFACE

— Low cost unit without IEEE address decoding  
— Also suitable for Anadex DP 8000 Printer £45

### PET MEMORY BOARDS

Internally mounting memory boards — also available with EPROM sockets: 24K — £328; 32K — £432

### IEEE — 488/RS232C SERIAL INTERFACE TYPE B

- Fully Bidirectional — PET Disc compatibility
- Switch selectable and Crystal Controlled Baud Rates
- Lower case printing
- Full operating instructions and sample programs supplied
- Boxed units complete with connectors £186

Available now:

### COMPUCOLOR II MODEL 3

- 13" 8-Colour CRT, 8080 Microprocessor
- 16K extended disk BASIC in ROM
- 71-key detached keyboard
- 8K RAM memory for user programs
- 64 characters per line by 32 lines per page
- Special graphics package with 128 x 128 point plotting
- Built-in mini-floppy disk drive
- 50 pin bus
- RS-232 I/O port for serial printers, etc. £1,058

TERMS: All prices Ex. VAT. Please make C.W.O. Cheques payable to: SMALL SYSTEMS ENGINEERING LTD. Post and package (includes SECURICOR delivery): £5 All goods supplied under 90 days' warranty.

• Circle No. 171



## CRYSTAL ELECTRONICS

## CC ELECTRONICS

### 8K XTAL BASIC FOR NASCOM I

1. Commands — CALL CLEAR CLOAD CONT CSAVE READ DATA RESTORE DEF-FN DIM EDIT END FOR TO STEP NEXT GOSUB RETURN GOTO IF THEN INPUT LIST NAS NEW ON GOTO ON GOSUB OUT POKE PRINT REM RUN SPEED STOP WAIT SPC() TAB() POP PRINT
2. Variables — Names must start with a letter, but can be up to any length. First two characters used to distinguish one variable from another. Strings of up to 255 characters, also Multi-Dim, Arrays and String Arrays. Numbers range from +/ -1E +/- 38, with an accuracy of six significant figures.
3. Functions — ABS ASC ATN CHR\$ COS EXP INP INT LEFT\$ LEN LOG MIDS PEEK POS RND RIGHTS SGN SIN SIZE SQR STR\$ TAN VAL
4. Operators: — Arithmetic: + - /\* ( 'To the Power of')  
Relational: = < > <= >=  
Arith-Logical: + (Concatenation)  
String: + (Concatenation)
5. Cassette commands — CSAVE CLOAD for saving and loading programs. Also CSAVE@ CLOAD@ for saving and loading of numerical arrays.
6. Special Commands — EDIT — Powerful line editor. CALL — Machine code subroutine call. NAS — Return to 'NASBUG' under software control. OUT, INP & WAIT — for control of I/O ports.
7. Compatibility — Tape routine provided for use with T2 Monitor. Fully compatible with T2, T4 & B-Bug Monitors.
8. Size — Actually fits in 7K of Ram (1000H-2BFFH). But recommend 16K Expansion Ram in your system.
9. Availability — On C12 cassette tape, with documentation, NOW.
10. Price £35.00 + VAT.

**MINIMUM SYSTEM GAMES TAPE £6+ VAT**  
**TINY BASIC GAMES TAPE £12+ VAT**  
**NEW WORD PROCESSOR FOR XTAL BASIC £70+ VAT**

### WHY BUY AN IMITATION GREY WHEN THE REAL CREAM IS AN APPLE THE SW AGENTS

APPLE II 16K (colour)	£920
48K/64K RAM, WITH 8085 CPU	£90 fitting & testing £10 extra
APPLE II 16K (B&W)	£830

ALL APPLE ADD-ONS NORMALLY IN STOCK

APPLE SOFTWARE:	MANY GAMES FROM £5-£15.00
STOCK CONTROL:	£100
NEW WORD PROCESSOR	£140, including lower-case adaptor package
LETTER WRITER	

**ALL PRICES EXCLUDE VAT & CARRIAGE**

### DURANGO

THE FIRST FULLY INTEGRATED DESK-TOP SYSTEM  
DUAL QUAD-DENSITY MINI-FLOPPY DISCS FOR 1.9M BYTES ON LINE  
9x9 DOT-MATRIX BIDIRECTIONAL PRINTER, 16cps, VARIABLE WIDTH  
48K/64K RAM, WITH 8085 CPU  
FULL KEYBOARD WITH 10-KEY NUMERIC PAD  
VDU WITH 24x80 or 16x64 CHARACTERS  
POWERFUL DISC BASIC (14-DIGIT ACCURACY)  
MULTI-TASKING TO 4 USERS PLUS OPTIONAL 20 M-BYTE FIXED  
APPLICATION SOFTWARE — SMALL BUSINESS, A/C PAYABLE/RECEIVABLE,  
GENERAL LEDGER, ORDER ENTRY/INVENTORY CONTROL, INVOICE/SALES  
ANALYSIS, PAYROLL, ETC

**PRICES FROM £7,500**

TEXAS TI-PROGRAMMER, A MUST FOR MACHINE LANGUAGE BUFFS,  
HEX-OCTAL-DECIMAL CONVERSION, ARITHMETICS OPS, IN THREE BASES,  
SHIFT LEFT/RIGHT, IS COMPLEMENT, OR, AND, XOR, ETC.

**£46-25**

SHOP OPEN	TEXAS TI89/4	40 MAGDALENE ROAD
0930-1730	HOME COMPUTER	TORQUAY
EXCEPT	PHONE	DEVON
WED & SUN	FOR DETAILS	ENGLAND
Closed for lunch		Tel: 0803 22699
1200-1300 hrs		

NASCOM NATIONAL DISTRIBUTOR TRADE INFO WELCOME

Shop open 0930-1730 except Wed. & Sun.  
40 Magdalene Road, Torquay, Devon, England. Tel: 0803 22699

Access and Barclaycard welcome.



**COMPUTERS  
AND  
COMPONENTS**



• Circle No. 172

44

PRACTICAL COMPUTING November 1979

we're taking  
the lid off the  
computer  
business



isher-woods offer a professional service, tailor made to fit your personal requirements

With the help of Commodore Systems and the PET® Computer, isher-woods can offer both the technically minded and the business man ready made or tailored solutions to most of your particular problems.

The Commodore PET® comes in 4 different memory sizes and is priced from as little as under £500 (ex VAT) for the 4K version. We can supply 8, 16, and 32K versions from stock, fully tested and guaranteed, together with Commodore, Floppies and Printers.

If you have a PET® or are considering buying one then we can look after it for you. Our in-house maintenance department makes a fixed price labour charge of £20 + parts at list price + VAT; just deliver to our door and we'll put it right.

If you just want the parts then we can supply them from our "CHIP SHOP". A comprehensive stock of Commodore and Petsoft tapes are always available. Ring PAM for further information.



**isher-woods**

Computer Systems Group

110/112 Leagrave Road. Luton Tel: (0582) 424851/39570

Sellers of PET® and other fine computer systems.

• Circle No. 173

# BOOKS·BOOKS·BOOKS

**BOOKS** Our most popular titles:-

Introduction to Personal and Business Computing. £5.45

Microprocessors Chips to Systems. £7.95

Microprocessors - Interfacing Techniques. £8.75

Introduction to Microcomputers

Vol 0 - The Beginners Book. £5.95

Vol. 1 - Application Techniques. £6.30

Microcomputer Primer. How they work for beginners. £6.35

Z80 Microcomputer Handbook. £6.95

Z80 Assembly Language Programming. £6.95

Z80 Prog. for Logic Design. £6.30

Illustrating Basic. £2.25

How to Profit from your Personal Computer. £5.50

6502 Applications Book £8.95

Programming the 6502. £7.95

Instant Basic. The fun way to learn. £7.20

Basic Basic. One of the most widely sold. £6.50

Advanced Basic. £6.00

How to Program Micros. Assembly Language for 8080, 6800 & 6502. £6.95

How to Build a Working Digital Computer. £4.60

How to Build a Computer-Controlled Robot. £5.95

Peanut Butter & Jelly Guide to Micros. £6.45

Small Computer Systems Source Book, for newcomers - practical knowledge. £6.10

Cobol with Style (proverbs) £5.40

Practice Problems in Number Systems, Logic and Boolean Algebra. £4.95

Some Common Basic Programs, 76 programs, finance maths etc. £6.45

Scelbi 6800 Gourmet Guide £7.95

Scelbi 8080 Gourmet Guide £7.95

Scelbi 8080 Standard Editor £9.95

Scelbi 8080 Standard Assembler £15.95

Scelbi 8080 Standard Monitor £9.95

Basic Computer Games £5.50

Computer Quiz Book £5.45

1976 U.S. Computer Chess Championships £6.25

Starship Simulation £5.45

Fun with Computers and Basic £5.45

Intro. to Computers and Basic

The Best of Byte £8.95

The Best of Creative Comp Vol. 1 or Vol. 2 £6.95

General Ledger £10.95

Accounts Payable/Receivable £10.95

ITT 2020 Handbook Set £20.00

Cromemco Catalogue £1.00

Scelbi 8080 Standard Editor £9.95

Scelbi 8080 Standard Assembler £15.95

Scelbi 8080 Standard Monitor £9.95

Basic Computer Games £5.50

Computer Quiz Book £5.45

1976 U.S. Computer Chess Championships £6.25

Starship Simulation £5.45

Fun with Computers and Basic £5.45

Intro. to Computers and Basic

The Best of Byte £8.95

The Best of Creative Comp Vol. 1 or Vol. 2 £6.95

General Ledger £10.95

Accounts Payable/Receivable £10.95

ITT 2020 Handbook Set £20.00

Cromemco Catalogue £1.00

## NEW

Computer Capers. Tales of electronic thievery embezzlement and fraud! £5.95

David Lien. The BASIC Handbook. Virtually an encyclopedia! A Must! £11.50

A Colin Day. Fortran Techniques Spec. ref. to non-numerical applications. £2.25

Murray Laver. Intro to the Uses of Computers. Includes appreciation of problems computers can handle outside purely mathematics £3.50

D. W. Barron. An Introduction to the Study of Programming Language. A comparison. £2.95

Donald M. Monro BASIC. Not to be confused with J. Coan's title. A must! A bargain! £2.00

Martin Whitbread Microprocessor. Applications in Business and Industry. Must for decision makers. £10.00

Send s.a.e. for full list. Prices correct at going to press. Add 12p insurance on books if required.

'Phone in your Access/ Barclaycard No.

**0742-585490**  
or complete this order form

**Cromemco** ITT 2020 applz II

**PET nascom-I**  
TEXAS INSTRUMENTS

I enclose - E  
Cheque/Postal Order No. ....

Please supply

Barclaycard/Access No. ....

Name: .....

Address: .....

**Datron Micro Centre,**  
Latham House, 243 London Road, Sheffield S2 4NF. Tel: 0742-585490

• Circle No. 174

## \*\*\* COMMODORE BASIC \*\*\*

### 31743 BYTES FREE

## READY.

PAM is a self-contained add-on memory unit for PET computers. It is available in 8K, 16K, 24K and 32K versions. 8K cards are available to augment all but 32K versions at a later date.

Operation is simply by plugging-in to PET's memory expansion port, using the high-quality, protected connector provided, and to the mains. PET power consumption, temperature and warranty are unaffected.

The standard, 24K version upgrades PET's memory to the full 32K addressable in BASIC, giving over 4 times the capacity of the standard 8K PET.

All units are guaranteed for 6 months and are supplied with full instructions

PRICES—8K £154

(ex VAT) 16K £232 plus £4.50 carr.

24K £310 and insurance

32K £367

8K plug-in card £78 plus £2.50 carr. and insurance

Prices are correct at time of going to press—subject to change without notice.

**OMB electronics, Riverside, Eynsford, Kent DA4 0AE**  
Tel: Farningham (0322) 863567

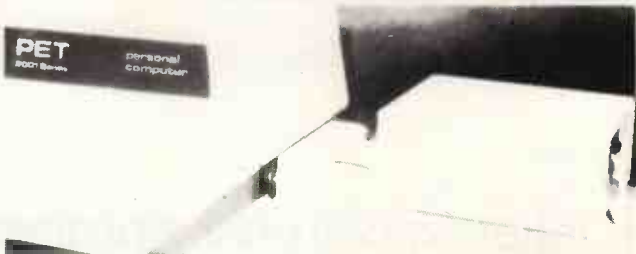

• Circle No. 175

# At last! Britain's very own monthly journal for Microsoftware, the LIVERPOOL SOFTWARE GAZETTE

ONLY 50p PER COPY



First issue includes:

SARGON meets the Nascom-1 — J. Haigh.

Pascal and the PET — J. Stout.

Programming practices and techniques — Dr. M. Beer.

I'm Pilot, fly me —

D. Straker.

Letter from America

— D. Smith

Apple pips —

C. Phillips.

Please subscribe 1st 12 issues of "Liverpool Software Gazette"

I enclose cheque/PO for £6.00

Access No. ....

Barclaycard No. ....

Name .....

Org .....

Address .....

Post Code .....

Mall to: Microdigital Ltd FREEPOST (No Stamp Required), Liverpool L2 2AB.

• Circle No. 176



# Don't Be Left Behind You Too Can Discover microPOWER

## EXIDY — Main Dealer

The Sorcerer Business System £2999 + VAT  
32K Computer with 8K BASIC Rom Pac  
80 Column Printer  
9" Monitor  
Dual Disk System — 633 Kb  
S100 Expansion Unit  
CP/M & CBASIC  
Graphics facilities, pre-defined and user defined.  
63 key ASCII Keyboard and 16 key numeric pad.  
Various disk systems available to over 1 megabyte.  
ROM PACS available now — ASSEMBLER, WORD PROCESSING, EPROM.  
Cooling fan for S100 units £16.75.  
Manuals ex-stock.  
8K, 16K and 32K machines.

## CROMEMCO

Z2 and Z3 Systems.  
Outstanding professional machines.  
Fast Z80 CPU with 21 card motherboard.  
Software support includes COBOL, FORTRAN IV, 16K EXTENDED BASIC, MULTI-USER OPERATING SYSTEMS, DATA BASE MANAGEMENT SYSTEM.  
Now on short delivery.

## PRINTERS — All Ex-Stock

DOLPHIN BD80. The best in its price range.  
The 80 column printer with many features. £595.  
PRINTERM 879 Matrix Printer 120 cps. £695.  
OKI DP100 — 132 column 275 cps 125 lpm. £2400.

## DISK DRIVE UNITS

SHUGART  
MICROPOLIS  
NORTH STAR  
PERSCI

## VDU's

BURNT HILL BH 720. Graphics, text, underline, protection, blink and invert £795.  
ELBIT DS 1920 £575.  
ELBIT DS 1920X. The new improved cost conscious compatible terminal £750.

## MONITORS

Professional quality 9" £145 and 16" £175 (ideal for teaching).

**SHOWROOM and OFFICES**  
34B London Road, Blackwater,  
Camberley, Surrey.  
Telephone: 0276 34044. Telex 858893

**COMPUTER BOOKS** — We carry a large stock of Micro books. Orders sent out same day except in cases of very high demand, when we will inform you of delay.  
Extensive catalogue available — Micro, Mini and Mainframe.

**SOFTWARE** — On cassette and disk and written to customer requirements.

**MEDIA** — Floppy Disks 5" from £25 box of 10  
8" from £32 box of 10  
Library Cases 5" £2.99  
8" £3.49  
Computer Cassettes C12 £4.00 for 10

## BEAR BAGS — AREA DISTRIBUTOR

Build your own 6800 based computer. Active user group.  
Bear Bags and PCB's always in stock.

## PRINTER PAPER

12" x 9.25" Single part plain, tractor feed with tear-off edges.  
Ideal for word processing — each page A4 size.  
Per box 2000 sheets £14.00.  
Other sizes available.

Orders taken for pre-printed continuous stationery, to your exact company requirements.

## WORK STATIONS

Made to fit your hardware configurations.

All prices + VAT and P/P.

Maintenance contracts available.  
Leasing and H.P. arranged through leading finance houses.

Feasibility studies to help you decide on the system that is right for you.

Customer support and technical back-up.

## ACCESS, BARCLAYCARD and TRUSTCARD.

Personal Callers Welcome.  
Please phone first if you require a personal demonstration.  
Mail orders and official orders accepted.  
Quantity discounts available.

open Monday - Friday 9 a.m. - 6 p.m.  
Saturday 10 a.m. - 5 p.m.  
On Main A30

• Circle No. 177

# MEGABYTES FOR YOUR PET. CONTACT: **B&B CONSULTANTS**

## PRINCIPAL CONSULTANTS FOR THE NORTH WEST

ITT 2020  
NOW IN STOCK

SEND LARGE SAE  
FOR THE LATEST  
INFORMATION AND  
DISCOUNT DELIVERY  
PRICES TO:  
**B&B CONSULTANTS**  
124 NEWPORT STREET  
BOLTON, LANCS.  
OR TELEPHONE: BOLTON  
(0204) 26644

• Circle No. 178

## COMPUTER **ICOM** COMPATIBILITY

THE NEW GENERATION OF ICOM AMATEUR RADIO TRANSCEIVERS USE MICROPROCESSORS OR L.S.I. CHIPS FOR FREQUENCY SYNTHESIS.

This means that they lend themselves to computer control for such things as automatic frequency scanning, automatic logging and automatic receive and transmit of Morse code and Radioteletypewriter data when interfaced with home computers. In fact we have a cassette program for the PET, coupled to an IC-21E VHF transceiver to scan and log the usage of channels over any period of time -- (£15 cassette or £20 PET mini floppy).

WHY NOT LET YOUR COMPUTER TALK TO OTHERS?  
AMATEUR RADIO IS A GOOD FOLLOW-UP FROM HOME COMPUTING!  
WHY NOT TALK TO US ABOUT IT -- SEND DATA AND PROGRAMS OVER THE AIR!



IC-211E VHF Base Station -- Local



IC-255E Car Mobile -- VHF



IC-701 H.F. Worldwide!



IC-280E Remote Mounting Car Mobile -- VHF.

Phone, write or put a message on our Ansafone for catalogues and Price Lists.

**THANET ELECTRONICS**

143 RECVLVER ROAD  
HERNE BAY, KENT

PHONE (02273) 63859 (2 lines)  
TELEX 965179

• Circle No. 179



# MAXIMUM CAPACITY COMMERCIAL SYSTEM

INCREDIBLE £1995† VALUE!!

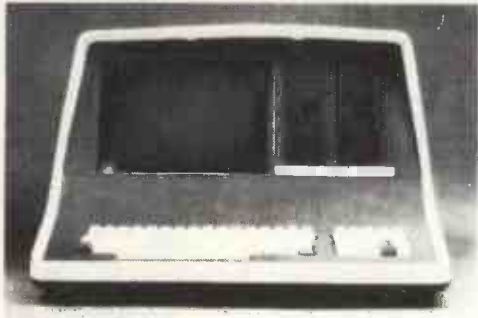

THE PERFORMANCE LEADER!!

THE PRICE LEADER !!!

**INTERTEC SUPERBRAIN™**

Dual Z80A 4MHz Vector Interrupt  
64K RAM plus 1K 2708 PROM Bootstrap  
TWO Double Density 5" Floppy Disk

\* Yes: That's the Right Price

## YES! THE SUPERBRAIN IS HERE!

See us all at THE INTERNATIONAL BUSINESS SHOW,  
Birmingham Exhibition Centre from 23 Oct — 1 Nov

**ICARUS COMPUTER SYSTEMS LTD**

**NATIONWIDE DISTRIBUTOR**

**£2,000 FREE CONSULTING!**

- Via non-returnable government grant 100% of first £2,000 available to:  
Qualified Industries and Manufacturers: Small, Medium, and Large
- You shouldn't settle for expensive limited function accounting systems £8-12,000
- You probably don't need a Minicomputer-Mainframe at £15-50,000 + +
- Many firms, large and small, are fully served by flexible microcomputer systems:  
Today's technology at a fraction of mainframe costs: typically only £5-15,000!
- The Government Department of Industry wants you to know the facts by way of:  
A Mapcon registered consultant: non-believers are invited to ring  
Dept. of Industry Mapcon at Stevenage (0438) 3388 for the attention of Mr. Nish

## NEWCASTLE UPON TYNE'S OWN

MICROCOMPUTER SYSTEMS HOUSE: MULLER (ANGLO AMERICAN COMPUTERS) LTD.

- **CONSULTING:** Microcomputer Systems Analysis & Feasibility Studies NATIONWIDE MAPCON  
Registered Consultancy: See above: Why do without the facts?
- **SYSTEMS DEVELOPMENT:** Integrated Software & Hardware TURNKEY Systems  
Start-to-finish Professional Design, Development, and Maintenance  
Fully-customised Programming and System Integration  
Low-cost Standard Business Software: Specialists in low-cost computerisations  
Give us the TOUGH Jobs: the ones that Increase Business & Profits:  
Automated Estimation-Tendering, Process Control, Production Management  
Distributed Processing (Multiprocessing), Management Information
- **EXPERIENCED DEALER:** We feature the SDS-200 Maximum Capacity Business System  
See UK Distributor's Advert AIRAMCO in this and previous issues of Practical Computing.

E FLOOR, MILBURN HOUSE, DEAN STREET, NEWCASTLE ON TYNE (0632) 29593

• Circle No. 180

WALES LEADING  
SYSTEMS HOUSE



14 CHEPSTOW ROAD  
NEWPORT, GWENT.  
50528 / 841691 / 63310

Incorporating (Microcourier)

At Micromedia we are usually asked for Complete Business Systems, here are a few examples.

	Purchase Price	Lease P/M
Accounting Package Sales Invoicing / Credit Controls Payroll on Alpha Micro, with 10 Megabyte Disk, visual display unit and printer.	17.950	448.75
Purchase Accounts, Sales Accounts, Payroll on Cromemco System III with work station, visual display unit and 180 c.p.s. printer.	7.950	198.75
Word Processing, Payroll, Accounts, on North Star Horizon with printer visual display unit and additional monitor.	5.500	137.50

Call us for a quotation on :

Cromemco II & III

North Star Horizon

Alpha Micro

Compucolour II

Commodore Pet

S W T P 6800

Microstar 45

#### APPLICATION SOFTWARE

Mailing Lists  
Data Base Management  
Accounting Suites  
Stock Controls  
Simplex Linear Programming  
Personel Records  
Fleet Maintenance Records  
Word Processing  
Pert (Critical Path Analysis)  
Purchase Ledger  
Sales Ledger  
Medical Records  
These are a selection from the range please call us to discuss your particular application.

We specialize in systems for Business Industry and Education and have specialist staff to discuss your applications.

Visual Display Units	From £	Printers	From £	Odds 'n Sods	£
Adds Regent 20	605	Anadex DP800	575	M22 Paper Tape Reader Punch	975
Adds Regent 25	645	S W T P PR 40	250	M33 Paper Tape Reader	450
Adds Regent 40	865	OKI E T 5200	485	M63 Paper Tape Reader Punch	1495
Cifer 2600	600	Teletype 43 KSR	840	Servogor Graphic Plotter	2750
Dec VT 100	1100	Dec LA 34	895	Sigma Graphic Option Controller	2168
Elbit 1920/30	725	Dec LA 36	905	Single side mini Diskettes Per 10	30
Elbit 1920/30x	750	Dec LA 120 KSR	1675	Single side 8" Diskettes Per 10	35
Infoton	610	Diablo 1640 RO	2098	C12 Cassettes Per 10	475
Lear Siegler ADM 3A	595	Diablo 1640 KSR	2292	Large range of computer books send SAE for list.	
Newbury Lab Range	From 495	Texas 743	1195		
Pericom 6801	985	Texas 810	1450		
Pericom 6802	1085	Tally Range from	1895		
Pericom 6803	1285				

OEM TERMS & QUANTITY DISCOUNTS AVAILABLE WRITE FOR DETAILS

• Circle No. 181

# The language dilemma

OVER THE LAST YEAR there has been talk about a wonderful new language called Pascal. It is said, by those who favour it, that it is much better than Basic in every way; that everyone should immediately learn it; and that when they have done so, a new era of light and harmony will settle on the micro-computing world.

It is further suggested that *Practical Computing* should publish a course on Pascal, as was done for Basic, and that listings in that language should be published exclusively.

If the suggested end-results of peace and harmony were certain, one would have no doubts but that is far from being the case. There is one striking fact about the microcomputing scene — there is far too much of it. There may well be too many types of computer, too many peripherals, and far too many languages — including some 20 dialects of Basic. We could all probably find satisfaction with only two of three of each item, and far fewer languages.

Basic has many faults. It is slow, badly adapted to building hierarchies of program. One can, no doubt, use five lines of Pascal for what it takes 50 lines of Basic to accomplish, and the result will run in one-tenth the time. The supporters of Pascal say that it is elegant, compact, quick, and so designed that it forces habits of clear thought on to the user.

That comparison ignores the best thing about Basic, that almost everyone in microcomputing understands it. It is the *lingua franca* of microcomputing — pidgin Fortran, perhaps — but a most powerful and welcome unifying force.

That was obvious from perusing the first results of our readership survey. We asked what languages people used and you answered in the following percentages:

Basic 74; Fortran 27; Cobol 16; Algol 11; Pascal four; Pilot three; APL two; LISP one; SNOBOL nought; others 20.

So that people write roughly one-and-a-half languages each, of which Basic is the one.

Is it worth sacrificing this surprising degree of unanimity for the sake of yet another language, however elegant? It is as if Caxton, with his first printing press running, was visited by a clever fellow who said he thought Olde Englysshe was a load of rubbish and why not publish books in Sanskrit, which is such an elegant language; and when Caxton replied that his readers and authors all read and wrote Olde Englysshe but did not know Sanskrit from a dog's calling card, his visitor said: "They can learn it and then write their own books."

It is little appreciated at this stage in microcomputer development how like it is to a printing press. People can and do write English in small amounts but they do not expect to be called upon to write their own newspapers, magazines, novels, histories and scientific texts. The point of written language would be lost if they did.

The first requisite for a culture is a common language and, to a large extent, we already have that. Surely we should be more concerned with standardising Basic than with fragmenting our means of communicating with each other?

It is amusing that while everyone admits that the most serious disadvantage to Pascal is the difficulty of learning it, the people keenest about it are academics in computer science. Can it be, one asks cynically, that they are making work for themselves? No doubt they would answer that the hard work needed to learn Pascal is imposed, not by the language, but by

the principles of clear thought which it embodies which would be difficult to learn in any guise.

While those habits may be satisfactory for the professional whose failure to think clearly may cost important computing resources, they may prove an insuperable barrier to the lay recruit. Naturally, perhaps, computing professionals under-estimate the second great virtue of Basic, that it is easy to learn. It was designed specifically to free the computer from the custody of professional programmers, and in that it has succeeded to admiration.

The microcomputer provides anyone with a few hundred pounds and a modicum of common sense access to a machine of enormous power. This machine is activated not only by the programs he can write himself but it draws on millions of man-hours of work by people all over the world during the last 10 to 20 years.

The newcomer is wary. He has been conditioned by two decades of ecstatic publicity for the wonder machines and the new breed of supermen who program them and it is hard to shake off the awe. It is vital to the whole development of microcomputing that the first 10 minutes a newcomer spends at the keyboard should be easy, fruitful — and fun.

Basic meets those needs. Turn on any micro, load Basic, and in a few keystrokes anyone should be able to make the machine do something. This first foothold in the edifice of computing is of immense importance.

After that, using Basic, there are few difficult ascents to bar one's progress. In my experience, the hardest single step was understanding disc files but by that stage I was not to be deterred. In retrospect, learning Basic was about half as difficult as learning to drive a car.

Can those who favour Pascal say as much? Can a complete novice write even five lines of program which will run? Because if he cannot the language is not suitable as a *lingua franca* for micros.

The key test is perhaps the frequency of how one hears people complaining: "If only I had wonderful Pascal, I could write this terrific program; but as it is, I'm stuck with Basic and it's all hopeless." That does not happen often. There are plenty of things one would like to do which need something better than Basic but they need something more drastic than Pascal, too.

If we must have a second language, what characteristics should it have? It should:

- Do things Basic cannot do, rather than the same things perhaps a little better.
- Be an interpreted language so that inept programmers like me can debug more or less as they write.
- Be available for at least several micros.
- Open a mass of existing but hitherto inaccessible software.

Even though those criteria are loaded slightly, they lead to only one answer — LISP. As those who read Mike Gardner's article in October will appreciate, one can easily do things in LISP which would be a real performance in Basic. Since textual information will increase rapidly in importance, because of the impact of affordable hard discs and Prestel, we need a language to cope with them rather than one to cope slightly better with what we already have.

If there is a vote, mine would go to LISP rather than Pascal. What do you think?

P.L.

## Program of the Year Competition

CONGRATULATIONS to Drs Georgina and Geoffrey Jolliffe on their winning entry, which appears in part in this issue. It was a pleasure to be able to award the prize to an entry which was immaculately conceived, executed and presented, and which uses a microcomputer for an eminently-useful and humane purpose.

**NRDC and NCC announce the**

# **BRITISH MICROPROCESSOR COMPETITION**

**A competition for the best invention  
incorporating a microprocessor**

**£20,000 total cash prizes  
First prize £10,000 ...**

... and NRDC will give favourable consideration to investing up to £½ million in any of the winning projects.

The competition closes on 14 December 1979. For full details, including entry form and rules and conditions, complete the coupon and post it to:

British Microprocessor Competition,  
c/o The National Computing Centre Ltd,  
Oxford Road,  
Manchester, M1 7ED.

Sponsored by the

**National Research Development Corporation  
and The National Computing Centre**

To: British Microprocessor Competition.

Please send me full details and entry form for this competition.  
BLOCK CAPITALS PLEASE.

Name \_\_\_\_\_

Address \_\_\_\_\_  
\_\_\_\_\_  
\_\_\_\_\_

PC

• Circle No. 182

**Our Feedback columns offer readers the opportunity of bringing their computing experience and problems to the attention of others, as well as to seek our advice or to make suggestions, which we are always happy to receive. Make sure you use Feedback—it is your chance to keep in touch.**

## Text packing

FOLLOWING my letter in the May issue seeking a text packing scheme to reduce the Adventure II data base, I had several interesting replies but only one detailed suggestion from Kay Dekker of Coventry.

In the meantime, I had devised my own simple scheme and programmed it in Fortran IV. It uses four bits for the common characters — Space E and the like — and eight bits for the rest, including several common two- and three-character combinations. Applied to the 63K characters of the Adventure II database it gives a mean bit rate of 4½ bits/character, which is probably slightly inferior to Kay's scheme, and reduces the total storage requirements of the program from about 50K 16-bit words to about 37K.

Several people now have this version in regular use, and it appears to run without noticeable disadvantages.

If anyone is interested in my scheme, or better still if they think they can improve on it, I would like to hear from them. I am sure that mean bit rates of less than four bits/character can be achieved and possibly even three bits/character, without introducing the unacceptable overhead of a very large word dictionary.

My aim is to promote an improved version of the Fortran subroutines PACKIT and WRITIT used in Adventure II. I am willing to test the efficiency of any version of these routines in packing the Adventure II database, and to include the routines in the program, with due acknowledgment, if they give a substantial improvement.

Incidentally, has any Adventurer yet found the secret of the chalice?

**Jack Pike,  
Chawston,  
Beds.**

## Bugs in the solder

I AM PROMPTED to write by Nick Laurie's comments on home construction in the August issue. Some time ago I had the task of building a Nascom I for a friend and after the problems we had I would hesitate to buy another kit.

Before soldering anything I took the precaution of checking all resistors, capacitors, diodes, and transistors with a multimeter and battery. That revealed that the 3.3V zener diode for the character generator had no zener characteristics. After replacing it, construction was completed, the soldering checked meticulously, and miraculously on powering-up everything seemed to work.

It was soon obvious, however, that all was not well. Like Laurie's Nascom, ours kept writing its own software throughout RAM. Typically this happened four to five minutes after power-on, just as one had typed-in a program or loaded a tape. We were using the Mark I PSU and although the current being drawn was less than 2A, the power transistor became very hot. It was fitted with a much larger heat sink but the problem remained. No other components appeared too hot. The most annoying thing was that although the computer usually failed after about five minutes,

occasionally it would work for hours before dying. The symptoms of death were wobbly screen, loss of keyboard response, followed by refusal to respond to re-set and a blank screen.

We wrote to Nascom describing the fault last January. Six months later the company replied, apologising for the delay, but with no useful suggestions. In the meantime we eventually traced the fault to the bridge rectifier in the PSU. Although it became warm it had not seemed too hot. When it was replaced by a bigger one on a large heatsink, the problem disappeared. Somehow the voltage on the +5V line must have been jittering enough to upset the CPU when the rectifier warmed-up.

**Anthony Short,  
Coulson,  
Surrey**

## African plea

THIS is a plea from the barren lands of Africa to the manufacturers of minicomputers. The development of small computers was aimed originally for the markets of Europe and U.S. Another area of great sales potential, however, must be Africa. Low-cost desk machines, such as the Pet series, have enabled many higher education institutions in Africa to buy their own small computers to increase their teaching options and widen research fields.

Users in countries like Sudan are faced with many difficulties, of which manufacturers may not be aware. Will the machine operate reliably under the prevailing atmospheric conditions — high temperatures, constant exposure to dust or high humidity? A low-cost machine becomes very expensive if a sealed, air-conditioned room is required for it.

Who will service and repair the machine in a country with few, if any, electronic engineers? It would be a great help if makers would find out the problems and provide the answers in their sales information.

One very aggravating problem is the mains voltage supply to a machine. Unlike the U.K., many countries do not have a reliable power supply. In Sudan, where the supply is supposed to be 240 V, the supply over a 12-hour period fluctuated between 180 and 215 V. All areas are also subject to irregular power cuts — extremely frustrating if one occurs during programming.

During a recent visit to the U.K. several possible solutions were investigated. They included using a DC supply from car batteries either by rectifying and then feeding direct or passing through a DC-AC converter, since car batteries are not subject to cuts and fluctuations and can be re-charged from the mains between cuts.

With the former, installation requires electronic expertise and appears incapable of powering a VDU; with the latter high power consumption limits the life of the batteries drastically. Apparently, the problem of power cuts will have to be accepted as part of life, and for the voltage fluctuation we are having to use a voltage stabilising unit at a cost of £150 — a substantial amount relative to the cost of our Pet 2001.

It would be a great help to African users, and

also a good sales feature, if manufacturers were to produce a simple, optional device to enable a DC power supply to be used to power minicomputers.

Finally, is there a user group for people outside Europe?

**Michael Robertshaw,  
University of Gezira,  
Wad Medani,  
Sudan.**

## Those dialects

YOUR SEPTEMBER editorial referred to the difficulty of moving Basic programs between machines. Although the use of Basic is unavoidable because it is by far the most common language supported on microcomputers, I have often felt that it is a mistake to publish complete programs instead of algorithms.

People tend to become too involved with the trivial details of Basic dialects and the attempts to transfer Basic A on to machine B lead to much tearing of hair and wasted time.

Would it not be more sensible, except in specialist cases, for Pet Corner to publish well-documented, structured algorithms and let interested parties re-write the algorithm in their particular dialect of Basic. This method has the advantage that the coder has thorough knowledge of the solution to the problem, and that a structured algorithm generally will result in better final programs.

I think that your magazine could be much-improved if you had more articles on teaching programming and less on teaching Basic dialects. As Dr Barry says, the details of the final language in which a program is to be coded are probably the least important factors in designing a solution to a particular problem.

Apart from this criticism, I find your magazine very interesting and informative. Keep up the good work.

**David Birch,  
Southampton University.**

## On target

THE EDITORIAL in September is the only thing I can remember seeing in any computer magazine that came close to portraying the "real world". You are to be congratulated, not just because of its good sense, but also because you had the courage to bite the various hands that feed you — the targets for your criticisms presumably being the same people who provide you with advertising revenue.

At least you will be loved by those among your readers who are engaged in trying to do the job properly either as dealers in micros, or in writing software for them.

Your analogy to the early 'bangers' can be extended. There is one well-known name which looked set to be the Model T of the micro world and certainly it has sold in vast quantities. Unfortunately, it does not work very well and the manuals issued so far contain so many errors that it is almost better to ignore them.

Those attending a dealers' meeting recently

*(continued on page 55)*

# SORCERER™

Now becomes a professional word processor...as well!



The Sorcerer Computer is a completely assembled and tested computer system ready to plug in and use. The standard configuration includes 63 key typewriter-style keyboard and 16 key numeric pad, dual cassette I/O, with remote computer control at 300 and 1200 baud data rates, RS232 serial I/O for communication, parallel port for direct Centronics printer attachment, Z80 processor, 4K ROM operating system, 8K Microsoft BASIC in separate plug-in Rom Pac™ cartridge, composite video of 64 chars 30 lines, 128 upper/lower case ASCII character set and a 128 user-defined graphic symbols, up to 32K on-board RAM memory, operators manual,

BASIC programming manual and cassette/video cables, connection for S100 bus expansion unit.

The Word Processor Pac creates, edits, re-arranges and formats text. Features include auto wraparound, dynamic cursor control, variable line length, global search and replace, holding buffer for re-arrangement of text, right justification, line width and line to line spacing, underlining or boldfacing, text merging and a macro-facility permitting tasks such as form letter typing, multiple column printing or automatic forms entry.

NOW CONTACT YOUR LOCAL DEALER



OR SEND COUPON FOR FURTHER INFORMATION



PRICES	£
8K Sorcerer	650.00
16K Sorcerer	760.00
32K Sorcerer	859.00
630K Dual Disc Drive	1,200.00
143K Single Disc Drive	500.00
S100 Expansion Unit	210.00
Line Printer	850.00
Video Display	240.00
Development Pack	70.00
Technical Manual	8.95
Daisywheel type printer	1,900.00
Word processing pack	80.00
Video/disc unit	1,800.00
16K Memory expansion	110.00

LANCASHIRE  
051-2272535 MICRODIGITAL 25 Brunswick St., Liverpool L2 BJ

WEST YORKSHIRE  
0535 65094 BASIC COMPUTING Oakville, Oakworth Rd., Keighley

SHEFFIELD  
0742-668767 E.S. MICROCOMPUTERS 7 Berkley Precinct, Ecclesall Rd., S11 8PN

NORTH WALES  
0248-52042 TRYFAN A/V SERVICES 3 Swifts Bldgs., High St., Bangor, Gwynedd

AVON  
0272-292375 ELECTROPRINT 5 Kingsdown Parade, Bristol BS6 5UD

NORTHANTS  
0536-83922 H.B. COMPUTERS LTD., 22 Newland St., Kettering

LONDON & Counties  
BERKSHIRE  
0635-30505 NEWBEAR COMPUTING STORE, 40 Bartholomew St., Newbury RG14 5LL

0753 22855 SLOUGH MICROSHOP, 120 High Street, Slough

KENT  
01-300 0380 INFORMEX 61 Harland Avenue, Sidcup, DA15 7NY

SURREY  
0276-34044 MICROBITS 34b London Rd., Blackwater, Camberley  
01688 0088 EMG MICROCOMPUTERS LTD. 30 Heathfield Road, Croydon  
0276-62506 T. & V.J. MICROCOMPUTERS 165 London Rd., Camberley

CHESHIRE  
061-445 8588 MICROPUTE 7 Westbourne, Manchester M20 8JA

Geoff Wilkinson, **FACTOR ONE Computers Ltd.** 11-17 Market Place, Penzance, Tel: (0736) 66336 or 66565

Please send me details of the SORCERER COMPUTER

Name \_\_\_\_\_

Address \_\_\_\_\_

Tel. No. \_\_\_\_\_

(continued from page 53)

were horrified to find that none of the company's staff in this country knew very much about how to use the disc drives which had been released, a situation improved only marginally by subsequent issues of copious notes and amendments. The same criticisms apply to the printers, although you cannot buy the tractor feed printer which has been advertised extensively.

It is as though Henry Ford has started the assembly line before he had found out how to fit the engines and wheels, in the hope that his customers would have the skill and patience to do the work themselves.

Incidentally, the three-way telephone conversation you mention arouses a certain amount of envy. We find that communicating with this particular company could not be more difficult if it was located on the dark side of the moon.

One of many letters to it ended with the exasperated question "Is there anybody there?" After three months there has been no reply and the subject of the complaint still sits lifeless, minus cassette drive and chips.

**Graham Garner,**  
Computer and Design Services Ltd.,  
Broadstone,  
Dorset.

## Joystick improvements

DAVID ANNAL'S article on home-made joysticks has a version using four microswitches operated by a moving washer attached to a knob. He says that this does not allow for any special codes to be generated, for instance, to produce a "FIRE" command. If the central washer is replaced by a thin square block (see diagrams) the code generated by all four switches being closed can be produced if the knob is rotated.

The first diagram shows the null positions of the switches. The knob can be moved up, down, left, right and diagonally to give the

same results as the original design. By rotating the block as shown in the second diagram it should be possible to make all the switches close.

With practice, and a carefully-made device, it may also be possible to make any three switches close. This would be done by moving the knob away from the switch which is to remain open, and rotating it to close the two switches on the sides of the block.

For this to be possible, it may require switches with a large amount of travel to enable the block to move far enough away from the switch which is to remain open, so that it is not closed when the block is rotated.

The third diagram shows the shape of the block. It is a thin square with a cut in each corner into which is placed a small piece of metal or anything else suitable to act as a stop, so that the operator has an indication when the switch arms are at the corners of the square. Otherwise the arms may flip the knob round suddenly when they pass the corners.

When the knob is at rest the springs should be pressing the sides of the block. The flat sides of the block will also mean that the arms press on the sides evenly as the block moves down. This should produce a more even feel, as the original design would have the side pressure lowered as the knob moves down and the arms move round the circular washer.

I have not as yet built this modified joystick and would be interested if anyone manages to make it work reliably.

**S. Goudge,**  
Eastbourne.

## Rental charges

AS A company dealing in both television and microcomputers, I feel well-qualified to provide an explanation on apparent high rental charges on small computers.

First and foremost the quoted charges are for short periods. Our hire models spend up to half their life on the shelf, and a considerable proportion of the cost is in the once-only

administration associated with a rental.

In addition to the machine, we provide at no extra cost manuals, text books, demagnetisers, tapes and sample programs, not to mention lengthy demonstrations and advice.

We are always pleased to provide computers for long-term hire on the same basis as television, namely an annual rental of about half the new cost, including full maintenance. Nevertheless, it appears that some firms overcharge and require too high a deposit.

With regard to maintenance, our experience is that microcomputers are more reliable and robust, and easier to repair than TVs — U.K. models anyway.

**M. M. Zepler,**  
Super-Vision  
Southampton.

## Know your rights

IN several recent issues of your magazine, many readers comment on the computer warranty problems they have encountered. A common complaint is the distance they have to travel to return goods to the retailer.

Your readers cannot be aware of recent Consumer Legislation which is summarised in a Retailers' Guide, printed by HMSO.

With bulky purchases it is clear that the consumer does not have a responsibility to return the goods to the retailer. Rather is it the duty of the retailer to provide the service at the house of the purchaser. This legislation has to be interpreted reasonably, but when spending £1,000 or more on a computer, it is not unreasonable to expect the retailer to provide a service over a distance, in return for the very high markups of between 25-60 percent which exist in the trade.

Finally, I would suggest that readers ignore the 30- and 60-day warranties seen on some computers; these statements would not be of any consequence in law.

**G.G. Grover,**  
Brighton.

## Complexities

I WOULD like to correct a few serious misrepresentations made by Nick Hampshire in the September *Practical Computing* about the Zilog Z-8000 microprocessor.

His comparison with the Texas 9900 is inaccurate. The Texas machine has a 15-bit address bus and is therefore capable of addressing 32,768 words, each of 16 bits. The Zilog Z-8000 is a byte-addressed machine and can address 8,388,608 bytes of store in each of six possible address spaces, namely for both system and user mode the cpu and an associated memory management unit (Z-8010) can address a code, data and stack storage space each of which would be as much as 8,388,608 bytes.

Thus the total possible memory address space is 50,331,648 bytes (48 Mbytes). The large address space is not, however, linearly addressed; the program counter in the segmented version (Z-8001) of the cpu is divided into a 16-bit offset which points to an even-numbered byte in one segment of the memory, which is chosen by the segment number which is stored in the HIGH byte of the second word of the program counter. This segment number is of six bits only and chooses one of 128 segments — 64 per memory management unit which, with the aid of the

(continued on page 57)

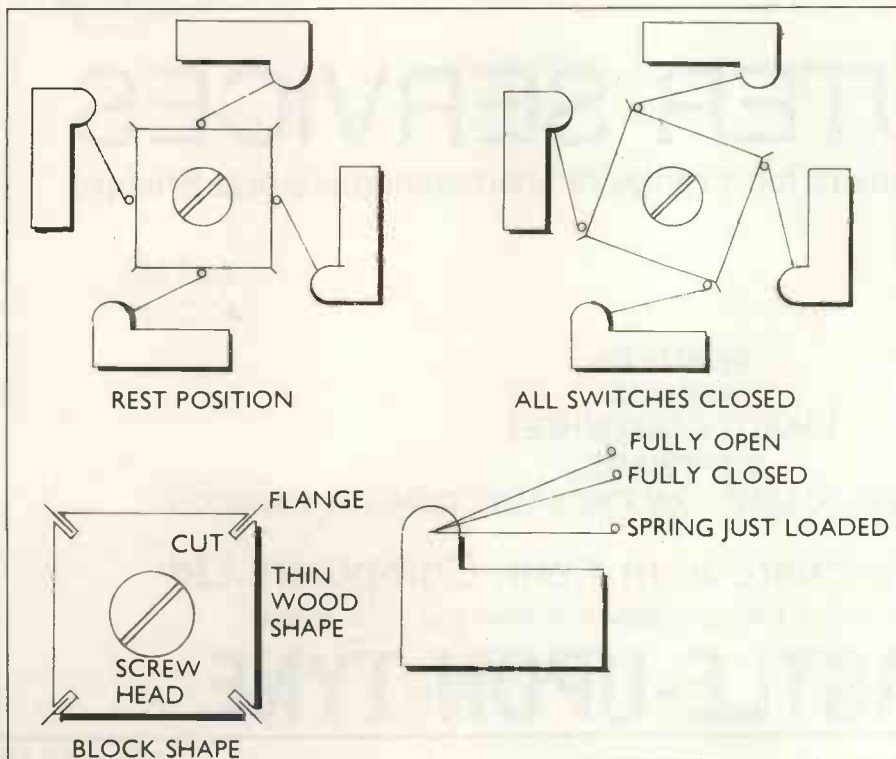

The microcomputer for those who need more than the minimum. The right processor for business, scientific and educational use. Proven applications include Games • Educational • Word Processing • Invoicing • Stock Control • Sales Ledger • Purchase Ledger • Mailing • Scientific.

# THE NEW HORIZON

## Languages

Powerful Basic including sequential and random access disc files • formatted output • strings • line editor • machine language CALL • many other facilities. Optional additional software (under CP/M operating system) includes BASIC

compiler, FORTRAN and COBOL.

Horizon Z80A computer with 2 double-density disc drives and 24K RAM £1,823 (exclusive of VAT and carriage).

## The Horizon computer includes:-

### Specification

Zilog Z80A MPU • S-100 bus (12 slots) • Solid well-built case • Up to four Shugart mini-floppy disc drives, 180KB each • Serial port for CRT or Teletype • Real-time clock on motherboard.

Optional additional serial port and parallel port • Powerful operating system and monitor • Access to wide range of S-100 special application boards.

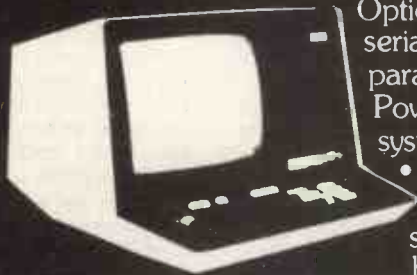

Equinox Computer Systems Ltd.  
"Kleeman House"  
16 Anning Street,  
New Inn Yard,  
London EC2A 3HB.  
Tel: 01-739 2387/9.  
01-729 4460.

• Circle No. 184



# P.I.P.S.



## COMPUTER SERVICES

North-East England Dealers for a range of Microcomputers and Printers

### HARDWARE:

APPLE II  
ZENTEC ZMS-70

AIM 65  
ACORN

### PRINTERS

ANADIX  
DIABLO DAISYWHEEL

### SOFTWARE:

INVOICING PACKAGE, CASHFLOW PACKAGE, DENTIST PACKAGE

Selection of Software from Keen Computers Ltd

Tel: John Page on (0632) 482359 482984 to discuss your requirements.

# NEWCASTLE-UPON-TYNE

• Circle No. 185



(continued from page 55)

processor status lines, maps the software address into a physical address.

Also, contrary to Hampshire's assertion, the Z-8000 does not use a pipelined architecture and there is no overlap of fetch and execute cycles of an instruction. For anybody who would like a closer insight into this very powerful processor, the preliminary specification from Zilog or a pair of booklets from Advanced Micro Devices, which is second-sourcing the device, are very informative and may clear any confusion in the minds of anybody thinking of purchasing this extremely powerful processor.

The Z-8000 seems to be the kind of processor needed to take personal computing out of the age of expensive toys and allow individuals to realise their own really powerful machines. Zilog compares the power of the Z-8000 to a Digital PDP 11/45 and it has more memory address capability than a PDP 11/70. It also has all the memory segmentation and protection features necessary to run really advanced operating systems and compilers for languages which are more than the bad joke which Basic has become.

It should be possible to implement languages like Algol 68, which is not dissimilar to Pascal but considerably more powerful.

They offer the micro user the opportunity to implement systems much more complex than is possible with today's 8-bit machines.

A R Kidson, Bromley, Kent.

●The Z-800 sounds terrific but does it offer any great advantages over 8-bit machines unless it has all that memory to address? Isn't the problem there the old one of hard cash?

Little Sir Echo

ECHOING the complaint of M G Hummel in your September Feedback, I and my colleagues have been attempting to buy a Micropolis dual floppy disc system for use on the Exidy Sorcerer for the last two months.

Among the excuses given for non-delivery have been:

"We've just sold the last of our consignment"; "Micropolis has just re-located its State-Side factory and supplies are a bit disrupted"; "The demand exceeds supply so we are allocating on a queue basis"; and "Oh yes, Tandy has bought the whole of next year's consignment of these systems and its version of the Micropolis disc system is not Sorcerer compatible".

I might say we have reached the depth of cynicism where we image that our supplier plucks his excuses from a tombola so that we don't get bored with having the same story twice.

A.C.J. Pepper, IIT Components Group, Harlow, Essex.

North Star game

YOU PUBLISHED my noughts and crosses game and have my 6502 disassembler program. I enclose text of a super game for North Star systems which I have been developing for some time.

It is definitely an adult game and is difficult to play but it represents a genuine challenge.

D.N. Sands, Intelligent Artefacts Ltd., Orwell Royston, Cambs.

```
1 REM G00A OFCODE DISASSEMBLER IN BASIC
2 REM WRITTEN D.N.SANDS 1979
10 PRINT"START ADDR";INPUTA:A=A0
20 FOR K=LTO4
30 IF MID(A;K;1)>"A" THEN 50
40 A=MID$VAL(MID(A;K;1));GOTO 60
50 IF MID(A;K;1)="" THEN A=AA 16+10
51 IF MID(A;K;1)="" THEN A=AA 16+11
52 IF MID(A;K;1)="" THEN A=AA 16+12
53 IF MID(A;K;1)="" THEN A=AA 16+13
54 IF MID(A;K;1)="" THEN A=AA 16+14
55 IF MID(A;K;1)="" THEN A=AA 16+15
60 NEXT
70 INPUT"NO. LINES "NL
80 FOR LN=1 TO NL
90 N=0:L=A:GOSUB 2000
91 D=PEEK(A):L=PEEK(A+1):H=PEEK(A+2)
92 F=D AND 28:PRINT TAB(10);
93 REM INTERPRET MAIN OPCODE
100 IF D AND 227=97 THEN PRINT "ADC";GOTO 1000
105 IF D=32 THEN PRINT "JSR";N=3:GOTO 990
106 IF D=76 THEN PRINT "JMP";N=3:GOTO 990
107 IF D=106 THEN PRINT "JMP INDIRECT";N=3:GOTO 990
110 IF D AND 227=33 THEN PRINT "AND";GOTO 1000
120 IF D=144 THEN PRINT "BCD";N=2:GOTO 1100
130 IF D=176 THEN PRINT "BCS";N=2:GOTO 1100
140 IF D=246 THEN PRINT "BEQ";N=2:GOTO 1100
150 IF D=88 THEN PRINT "BNE";N=2:GOTO 1100
160 IF D=208 THEN PRINT "BNE";N=2:GOTO 1100
170 IF D=18 THEN PRINT "BFL";N=2:GOTO 1100
180 IF D=90 THEN PRINT "BVC";N=2:GOTO 1100
190 LFD=12 THEN PRINT "BVS";N=2:GOTO 1100
200 IF D=24 THEN PRINT "CLC";N=1:GOTO 980
210 IF D=216 THEN PRINT "CLI";N=1:GOTO 980
220 IF D=88 THEN PRINT "CLD";N=1:GOTO 980
230 IF D=180 THEN PRINT "CLV";N=1:GOTO 980
240 IF D=202 THEN PRINT "DEX";N=1:GOTO 980
250 IF D=156 THEN PRINT "DVS";N=1:GOTO 980
260 IF D=232 THEN PRINT "INX";N=1:GOTO 980
270 IF D=200 THEN PRINT "INY";N=1:GOTO 980
275 IF D=6 THEN PRINT "BRK";N=1:GOTO 980
280 LFD=234 THEN PRINT "NOP";N=1:GOTO 980
290 IF D=72 THEN PRINT "PHA";N=1:GOTO 980
300 IF D=6 THEN PRINT "PHR";N=1:GOTO 980
310 IF D=104 THEN PRINT "PLA";N=1:GOTO 980
313 IF D=40 THEN PRINT "PLP";N=1:GOTO 980
320 IF D=64 THEN PRINT "RTI";N=4:GOTO 980
330 IF D=56 THEN PRINT "RTS";N=1:GOTO 980
340 IF D=56 THEN PRINT "SEC";N=1:GOTO 980
350 IF D=248 THEN PRINT "SED";N=1:GOTO 980
360 IF D=120 THEN PRINT "SEI";N=1:GOTO 980
370 IF D=170 THEN PRINT "TAX";N=1:GOTO 980
380 IF D=166 THEN PRINT "TAY";N=1:GOTO 980
390 IF D=186 THEN PRINT "TSX";N=1:GOTO 980
400 IF D=138 THEN PRINT "TXA";N=1:GOTO 980
410 IF D=194 THEN PRINT "TAS";N=1:GOTO 980
420 IF D=152 THEN PRINT "TIA";N=1:GOTO 980
430 IF D AND 227=2 THEN PRINT "ASL";GOTO 999
440 IF D AND 227=32 THEN PRINT "BIT";GOTO 1000
450 IF D AND 227=192 THEN PRINT "CMP";GOTO 1000
460 IF D AND 227=224 THEN PRINT "CPX";GOTO 998
470 IF D AND 227=192 THEN PRINT "CPY";GOTO 998
480 IF D AND 227=66 THEN PRINT "EOR";GOTO 1000
490 IF D AND 227=194 THEN PRINT "DEC";GOTO 1000
495 IF D AND 227=226 THEN PRINT "INC";GOTO 1000
500 IF D AND 227=162 THEN PRINT "LDX";GOTO 997
510 IF D AND 227=146 THEN PRINT "LDY";GOTO 998
520 IF D AND 227=164 THEN PRINT "LDA";GOTO 1000
530 IF D AND 227=166 THEN PRINT "LSR";GOTO 999
540 IF D AND 227=16 THEN PRINT "ORA";GOTO 1000
550 IF D AND 227=34 THEN PRINT "ROL";GOTO 999
560 IF D AND 227=98 THEN PRINT "ROR";GOTO 999
570 IF D AND 227=222 THEN PRINT "SBC";GOTO 1000
580 IF D AND 227=129 THEN PRINT "STA";GOTO 1000
590 IF D AND 227=130 THEN PRINT "STX";GOTO 997
600 IF D AND 227=128 THEN PRINT "STY";GOTO 1000
610 PRINT "UNDEF";N=1
620 L=D
630 PRINT TAB(25);:GOSUB 2000
640 PRINT"==NEXT LN
650 GOTO 70
660 PRINT TAB(25);:GOSUB 2000
670 GOTO 980
680 REM INTERPRET VARIATION OF CODE
690 IF F=20 THEN PRINT "Z-P-Y";N=2:GOTO 990
700 IF F=0 THEN PRINT TAB(24);:N=2:GOTO 990
710 IF F=8 THEN PRINT "ACC";N=1:GOTO 980
720 IF F=12 THEN PRINT "ABS";N=3:GOTO 990
730 IF F=3 THEN PRINT TAB(24);:N=2:GOTO 990
740 IF F=4 THEN PRINT "Z-P";N=2:GOTO 990
750 IF F=0 THEN PRINT "(IND);X";N=2:GOTO 990
760 IF F=16 THEN PRINT "(IND);Y";N=2:GOTO 990
770 IF F=70 THEN PRINT "Z-P-X";N=2:GOTO 990
780 IF F=26 THEN PRINT "ABS-X";N=3:GOTO 990
790 IF F=24 THEN PRINT "ABS-Y";N=3:GOTO 990
800 PRINT "UNDEF";GOTO 990
810 REM RELATIVE ADDR
820 H=L
830 IF L<127 THEN H=L-256
840 PRINT TAB(25);
850 L=L+H:GOSUB 2000
860 PRINT "(*)";
870 GOTO 980
880 REM DEC-HEX
890 IF N=3 THEN L=L+256*N
900 G=INT(L/4096):GOSUB 2500
910 L=L-4096
920 G=INT(L/256):GOSUB 2500
930 L=L-256
940 G=INT(L/16):GOSUB 2500
950 L=L-16:GOSUB 2500
960 RETURN
970 IF Q=10 THEN PRINT "A";:RETURN
980 IF Q=11 THEN PRINT "B";:RETURN
990 IF Q=12 THEN PRINT "C";:RETURN
1000 IF Q=13 THEN PRINT "D";:RETURN
1010 IF Q=14 THEN PRINT "E";:RETURN
1020 IF Q=15 THEN PRINT "F";:RETURN
1030 M=STR$(Q)
1040 PRINT RIGHT$(M,1);:RETURN
```

Improvement

I WAS most interested to read your September review of the Anadex DP-8000 printer. To bring your readers up-to-date, however, I should mention that all DP-8000s are now supplied with adjustable paper feed sprockets to accept any paper size up to 9.5in. wide and a self-check facility to print the complete character set, together with a diagnostic routine, is incorporated.

Also, a complete servicing facility is available from our main distributors, Peripheral Hardware Ltd, at East Molesey, as well as from a number of our recognised dealers. In addition, for those customers who require on-site support, a service contract is available from Kode Services Ltd, Calne.

For users who would like to carry-out their own servicing, a maintenance manual is now available from Anadex and we have recently increased our technical services staff to make information of this kind more readily available by telephone.

Finally, we have established that it is possible to stand a cup of tea on the DP-8000 — our service people are now insisting on a re-design of the case.

M.S. Hayward, Managing director, Anadex Ltd.

Unhappy

I DO not know how many of your readers have encountered difficulties in dealing with firms in the United States but would like to draw attention to my experience.

At the end of February, I sent a bankers' draft for 21 dollars to Jade Computer Products in California. It was for three months' trial membership of its software exchange (20 dollars), plus one dollar for an air mail reply. I would state that postage was not mentioned in the advertisement. I had no reply.

In April I wrote again, enclosing a photocopy of the original letter and a photocopy of the bankers' draft. I still received no reply.

I contacted my bank, which made enquiries on my behalf, and on June 21 received a reply that the draft had been paid to Jade on March 15. On July 10 I wrote again to Jade, stating that the position was unacceptable, and asking for a refund of my money, or details of the library before the end of the month. I have no goods, no money — and no more patience.

It would be interesting to hear if any other reader has experienced similar difficulties.

John D. Lee, Loughborough.

Exchange

I INTEND to set up a program exchange, entitled Micro News, it would be a newsletter, of about 10 pages covering programs for computers such as the Superboard, Nascom-1 & Exidy Sorcerer.

Martin Black, 11 Moorland Avenue, Higher Crumpsall, Manchester, 8;

●BEARING in mind the national shortage of microcomputer engineers and programmers, we think it may be interesting to publish an article on how people first found jobs in the business.

Since the people concerned know best about that, we would be interested to hear how you did it, whether you were happy with the results, what you think of formal courses as opposed to on-the-job experience, and so on. Please write to 'Getting Started', Practical Computing.

# Extra protection now for the customer

THE CUSTOMER for micro-computers looks like having some protection now the Computer Retailers' Association has been formed by 23 microcomputer retailers, including Keen Computers, HB Computers and Microdigital.

The object is to "maintain and improve standards within the industry and to present the

industry case to the outside world, including the Government and the lay Press."

Colin Stanley, of HB Computers, who has been involved from the beginning, says it intends to protect the rights of the customer and to "eliminate the type of company which asks for

money first and sends the computer later."

Conditions of membership are that firms must be microcomputer retailers; they must have a display area where products can be demonstrated; they must have a constantly-manned telephone on their premises during working hours; and they must have "expertise in software and hardware."

The most significant point, is probably that the association will meet the obligations of any of its members who are forced out of business, thus guaranteeing customers of members against loss. It will also continue servicing any machine bought from a company which was in the association and has since failed.

## Line change

THE Disassembler for the 6502 by D. Sands contained an error. The last character in line 2005 should be H, not N.

# Micros to make your car tick

THE MOTOR CAR of the future may well have a micro-computer at the heart of its operation. A simulation of things to come was shown on the BBC television programme *A Right to Work*.

Built by Scicon, it uses a magnetically-coded board with personal identity code instead of an ignition key. Before starting the engine the computer checks the complete car systems and warns the driver of any deficiencies via a single-line alphanumeric display.

The micro also communicates via a radio link to a central computer database to gain information on the best route to take avoiding obstructed roads. Through that link, the driver could also make hotel reservations, book a table at a restaurant, or

receive the latest new headlines.

While driving, the performance of the car, road conditions and journey details are monitored constantly and details written on one of the various displays.

All the features incorporated are geared to safer motoring, energy saving and improved communications.

## Geared to safer motoring.

## Computhink

JOHN BLACKBURN of B&B Consultants, Bolton, says his partner, Peter Binks, has managed to tweak the Computhink drive for the Pet to such good effect that one machine can now control four drives, storing 50MB.

The alteration consists of a piece of hardware and a piece of software. "If you order one now, I can give delivery in two hours", says Blackburn.

B&B Consultants, 124 Newport Street, Bolton, Lancs (0204 26644).

## Construction service

A KIT CONSTRUCTION service with charges of around 10 percent of system value for each kit built is being offered by a Truro company.

Logsign will supply or build kits or construct those the customer wishes to supply. It will also complete kits which customers have started to build and with which they have experienced difficulty.

Popular kits, such as Nascom, CompuKit and 77/68, will be dealt with and large systems, such as the Horizon, will cost around 25 percent of the original cost to build.

Enquiries to A. D. Cann, Logsign, PO Box 33, Truro, Cornwall.

## Conversion

ACULAB has a conversion box to interface a 7-bit parallel ASCII port to any IBM golf-ball printer. The output is slow but it can be cheap and the printing will look good. The interface will cope with five standard golf-balls.

Aculab Ltd., 24 Heath Road, Leighton Buzzard, Beds, (0525 371393).



## Help for CP/M users

WITH disc systems rapidly gaining ground, news about CP/M, the standard operating system for 8080 and Z-80-based machines, is of interest.

Peter Norman, of the Computer Centre, Swansea, says it recently received a new version CP/M 2, which will handle up to 128MB on hard disc. While that is of little use to people who already have CP/M 1 for floppy discs, it will be very useful to those who intend to acquire the 10MB drives.

Norman expects those drives, from DRI, will sell for about £1,500 for the 10MB version and £2,000 for 30MB, with the price falling after two years to about £500 at today's prices.

Incidentally, while the Computer Centre holds the 38 volumes of American software for CP/M, it has also accumulated two volumes of British material.

The Amateur Computer Club has also made an arrangement with Digital Research, owners of CP/M, and will be offering its library and systems at a discount to members. Contact is Alan Secker (868 1144).

## Lifeboat compilers

LIFEBOAT ASSOCIATES offers two compilers for "C" language and Version 5 Microsoft ANSI Basic. The compiled version runs five to 10 times faster than interpreted Basic.

Lifeboat has also released CP/M for the Altair disc system, which makes a large library of software available to users. Lifeboat Associates, 2248 Broadway, New York, NY 10024 (212 580 0082).

## Petite

PLESSEY has reduced the price of the Petite and Inpet expansion memories for the Pet, because increased demand has led to volume production. Petite will now cost £289 and the Inpet, an add-in card, £249.



**WINNERS** of the *Practical Computing Program of the Year* competition, Drs Georgina and Geoffrey Jolliffe, with their trolley-mounted Tandy system in a lecture theatre at Chelsea College, where they teach pharmacy.

## Impressive winning entry

THE Program of the Year award was won by Drs Georgina and Geoffrey Jolliffe, of the Department of Pharmacy at the University of London.

Entries were invited in five categories — business and administration; science and mathematics; computer art; games and simulations; and education projects.

The program which was judged by Jim Wood, a consultant of several years' experience, and the Editor of

*Practical Computing*, to be worthy of the main award is to aid the analytical identification of powdered vegetable materials used in goods and medicines. It would supersede the necessity for lengthy record retrieval by an experienced analyst.

The judges were impressed because the entry was well-thought-out and extremely well-presented, and because the application is a good and useful one.

## New colour board

THE Corvus 10MB disc available from Keen is, at £3,500, considerably more expensive than the promised but not yet available 10MB unit for the Pet.

Keen also has a new colour board for the Apple II, which improves on rather impure colours and defective control signals of the standard board.

The new board is designed for use with a 14 in. Sony, which has to be modified slightly. Two new utilities packs at £50 each are also available, including Sort, Search, Editor, Text Editor, and Super List for Basic programs.

## Easier code for Z-8000

ZILOG now has a package of programs to make it easier to write Z-8000 code. You need a simple Z-8000 satellite system connected to any Z-80-based microcomputer with discs.

The software suite contains a Z-8000 assembler, a linker, a translator to turn Z-80 Assembler into source files of the assembler, a macro pre-processor, an imager program to produce loadable binary files containing executable Z-8000 code, ROM programming package, and utilities to transfer data between files in the Z-80 host and the Z-8000 satellite.

Zilog U.K. Ltd., Babbage House, Maidenhead, Berkshire. (0628 36131).

The prize in the games and simulations category was won by Alan Baylis for his American Election Game, while J J Waters took the laurels in the science and mathematics section for his Analysing Linear Potential Flow problems.

There was no entry in the category for computer art and none of sufficient quality to win a prize in the section for education projects.

**Peter Sommer looks at the background to the use of microcomputers in amateur radio and reviews some hardware. He is deputy editorial director at Granada Publishing and a radio amateur — call sign G8PRR.**

AMATEUR RADIO was the first electronic hobby. Until the arrival of the solid-state diode and transistor made reliable low-power 'logic' switching possible, radio in its various guises was almost the entire content of electronics.

Amateur radio shares with astronomy, natural history, archaeology, computing and a few other activities an opportunity for talented non-professionals to make a real contribution to the advancement of knowledge.

Even for the less than highly-skilled, the process of learning about the hobby amounts to valuable self-training, which can be put to good use in other spheres. Some of the more advanced third world countries, for example, encourage 'hams' because it's an amazingly cheap and effec-

new form of modulation which occupies less space on the crowded airwaves and causes less interference to others? Or an audio filter which digs-out fading signals and eliminates heterodyne whistles from the background hash?

More ambitiously, can you contribute to a VHF or UHF repeater which, sited on a hill top, will boost low-power signals from a poor location so that they can be heard over a 20-mile radius, or even help with one of the amateur radio satellites? How about bouncing a signal off the surface of the moon, or waiting for a meteor shower or aurora which ionises the upper atmosphere for brief periods to permit freak VHF contacts?

Can you send TV pictures around the world, without recourse to the satellites

approaching or receding from the operator; forecast of meteor showers, forecast of propagation conditions — which at high frequency or short wave, to give it the older name, vary with time of day, time of year, and time in sunspot cycle.

- driving the station equipment through micro-control. There are now a number of off-the-shelf transceivers advertised as microprocessor-controlled, and though most readers would find such descriptions rather exaggerated, advances in methods of frequency derivation have made the interfacing of micros with rigs much more worthwhile.

Until recently the standard method of generating a radio frequency signal was via a parallel-tuned oscillator consisting of a variable capacitor and a coil, and driven either by a valve or a transistor. Today the basic oscillator remains unchanged but the variable capacitor can be replaced by a varicap diode, a device whose capacitance changes according to a bias voltage placed across it.

The level of the bias voltage is determined by a multi-turn variable resistor — a typical consumer version are the pre-sets on a domestic TV.

### More promising

Now it is easy for a micro to deliver measured bursts of voltage, particularly if there is a circuit with a built-in reference voltage and the appropriate 'comparing' logic.

More promising though, is the device of frequency by mixing the results of several oscillators. Dedicated chips perform all the desirable mixing functions — many chips, incidentally were developed for citizen band equipment — and the choice of frequency depends on feeding the appropriate chain of pulses to the correct pins on the chip.

The microprocessor can store frequencies in a 'memory' so that they can be summoned back at will. It can scan those frequencies to see if there is activity on the air. In one popular version, and in a number of mobile transceivers, the equipment runs up and down between two pre-determined frequencies looking for activity. When it finds a 'busy' channel, it stops, giving the operator an opportunity to decide whether to break in or to respond, and then, unless told to do otherwise, resumes scanning.

It is easy for a micro to display on its VDU all the activity within given frequency limits. It would also not be difficult to switch such transceivers into the frequency-hopping mode beloved of clandestine operators, except that the

# Computer aid provides new dimension

tive way of creating a pool of skilled electronics engineers.

It is not surprising that strong links exist between computer buffs and radio hams. Some of the earliest home computer constructors also held transmitting licences; the American magazine *Kilobaud* was spawned from a ham magazine called *73*. In the last 12 months many amateur radio stations have acquired micros with fascinating results.

Perhaps the least significant activity of hams is talking on the air. Given a reasonable amount of money, tolerable competence in setting-up and operating equipment — say a grade or so above soldering together hi-fi components and a modest knowledge of propagation — it is no great achievement to talk to someone on the other side of the world.

Hams explore the edges of what is technically feasible. Can you make contact on only five watts of power, or when conventional wisdom insists that a propagation path cannot exist? Can you develop a new antenna design, or adapt the newest transistor and integrated circuit technology to produce equipment which is more efficient, has more facilities, and is lighter in weight than ever before?

How about a speech processor which increases the intelligibility of a signal, or a

used by the broadcasting professionals? The picture is compressed into the same bandwidth used for speech — less than 3KHz compared to the 6MHz needed for standard colour TV — and a special slow scan rate used which changes the picture only every eight seconds or so, rather than every 1/25th or 1/30th sec; the mode is called SSTV.

### Specialisations

Many of these specialisations can be helped by a computer. In some cases the micro is doing more flexibly and graphically what the calculator did two years ago and what a few years before that was derived from tables, nomographs and slide rules. The amateur station with a micro can perform feats and conduct investigations and experiments which previously were not possible. They fall into the following categories:

- collecting, collating, and recording data which enable an amateur to be aware of advantageous conditions under which to carry-out experiments; movement of the various amateur satellites, calculation of doppler shift — amateur satellites are not geostationary so that the appropriate transmit and receive frequencies vary according to whether the satellite is



**Peter Sommer at work in his lair shack. Note the Pet in the foreground sending morse.**

transmitting and the receiving station, provided it is locked in step, can hear each other because their frequency changes constantly according to a pre-determined cycle. It is not difficult, it is not legal, but it is difficult to enforce.

Plenty of equipment already allows the input of frequency to be executed from keyboard, rather than a tuning knob. Soon-affordable receivers which cover everything, not only the amateur bands, will have similar facilities; items now being offered to the military/diplomatic market have such arrangements already.

The Bearcat VHF/UHF scanner, popular in the States, will scan and search like amateur transceivers but over a much wider range — the 220 covers 32-50 MHz, 118-136 MHz (airband), 144-176 MHz VHF and UHF frequencies from 416 to 512 MHz.

## Twenty channels

It can also store up to 20 discrete channels which can be scanned individually at either of two rates, and will also, on the striking of only one key, scan the entire air band and, on striking another, do the same for the marine VHF bands.

Unfortunately there is no direct interface for a micro.

Similar facilities on high-frequency — short wave — equipment would mean that the listener could take advantage of the fact that many signals are sent simultaneously on a number of frequencies to overcome the vagaries of ionospheric conditions.

A computer-controlled HF receiver could sample continuously all the likely frequencies of a given station and present the listener with the best one; the technical named for this is frequency diversity.

The other aspect of equipment control is antennae. For individuals concerned with the tracking of celestial objects, pointing the antenna in azimuth and elevation is essential — professionals have been using computer-driven servos for years. Now, prosperous amateurs can think in the same terms. It should also be possible to control the tuning of an antenna from a micro. Antennae used for transmitting need to resonate precisely in sympathy with the radio frequency in use if they are to work at their most efficient — and if the transmitter is not to be damaged, for RF power which does not reach to the ether tends to re-appear as

heat in the final stages of equipment.

It is normal practice to vary the electrical 'length' of an antenna by means of a passive tuning unit consisting of two capacitors and an inductance. This is done by hand these days; soon, direct output from a rig will send instructions to an antenna unit — probably placed in the air where it is most used — to tell it how to adjust itself. These developments are just around the corner:

- Using the micro to create an intelligent signal. Besides speech — or telephony, to use the proper name — other methods can be used to send information over the air. The oldest of the alternatives, and one which pre-dated speech, is the encoded stopping and starting of a continuous radio wave — CW. The best-known form of encoding is, of course, Morse, and because of its simplicity and the ability of CW to 'get through' where other transmission modes would be unsuccessful, it is unlikely to disappear for many years.
- There is no need for Morse, which depends on short and long bursts, as well as properly-timed silences, to be generated by hand and one of the more attractive add-ons instantly available to the micro/radio enthusiast is automatic encoding and decoding of Morse.
- The hardware/software device does more than relieve the operator of the burden of learning Morse Code. The micro can generate and decode at speeds beyond the ability of a human operator. The applications for military/ clandestine operations have been known for years, but for hams concerned with, say, meteor scatter, where a propagation path may last only a few seconds, a burst of high-speed Morse may be the only way to establish a worthwhile contact, so that both stations know enough about the other — location, type of equipment, power output — to make the exercise worthwhile.

The other frequently-used encoded transmission mode is a radio version of Teletype (RTTY) which uses a 5-bit code of pre-selected high and low tones to signify 'mark' and 'space' or binary 1 and binary 0, known as the Murray/Baudot Code. The 5-bit format is enough to give capitals, numerals and a few punctuation and instruction symbols, but lacks the versatility of ACSII.

On the other hand, in terms of transmission time, it is more economical. People have tried transmitting ASCII but the value for most applications is questionable. In addition to more dedicated RTTY terminals, one of which operates in Japanese as well as Morse, hard & software packages for a variety of micros are available for such popular

*(continued on next page)*

(continued from previous page)

models as Pet, TRS-80, KIM, Apple/ITT, and Nascom.

There are also micro-assisted devices to generate video for slow-scan television, particularly in association with the Apple/ITT computer. There are a number of experiments in other forms of data transmission, ultimately amounting to the sending, if need be, of computer programs over the air and getting micro to interface with micro by wireless.

Until the American regulatory authority, the FCC, is prepared to relax its restrictions, radio transmission of data — the concern is about encrypted signals which the National Security Agency may not be able to understand — progress in this area may be slow, because both the money and skills needed for expansion are concentrated heavily on the other side of the Atlantic.

Incorporating a micro into a radio station creates a number of difficulties, not all of which are obvious, so I will detail my experiences over the last month or so.

## Office test

While most magazines in the business of reviewing expensive hardware or consumer durables would have you believe that their offices are lined with glowing banks of sophisticated measuring equipment and populated by the kind of white-coated, clipboard-clutching laboratory denizens who advise you about headache pills in TV advertisements, that is not always a reality at *Practical Computing*. Experts are available and so is appropriate measuring gear but some reviewers are consultants or enthusiasts not so far removed from readers.

I wanted to review a small piece of interfacing hardware which links a micro — in this case a Pet, but a TRS-80 variant is available — and a transceiver to provide automatic encoding/decoding of Morse and RTTY signals.

The device is the Macrotronics M-65 and it is available either as a kit or assembled, together with software on cassette, well-presented and with comprehensive documentation. The device works as it is intended to do, so what follows is not a product review in the ordinary sense of the term.

My first intention was to set up a receiving station at *Practical Computing* offices in a vain attempt to startle a staff who reckon that, by and large, they have seen most miracles. I arrived with a popular communications receiver covering the short wave bands from 0.5 to 30 MHz — up to 10 metres — known as the Yaesu Musen FRG-7. It had had some fairly standard modifications. There is a digital (A-D) readout, narrow-band filtering for side-band and CW signals,

and discriminator for frequency modulation. To feed it with a signal, I erected a Datong active antenna, which while useless for transmission, is excellent for reception because of its short physical length and the lack of need to tune as the reception frequency is altered.

## Connections simple

The electrical connections were simple. Mains power for receiver, transformed and rectified low voltage DC for the amplifier in the active antenna, and mains again for the Pet.

The M-65 derives its power from the second cassette interface port on the Pet and the I/O from the unit goes, as one might expect, to the user port. You need some phono connectors to link the receiver audio to the M-65, a connector for a small loudspeaker to check the audio captured by the unit prior to transforming it into a form acceptable to the Pet, and also to act as an audible 'side-tone oscillator' on transmit or for operation of the 'practice' facilities the software also offers.

Yet another connector gives an output for a LED which provides visible indication of reception/capture by flickering in time with the signal. There are also outputs for transmitting, for driving the relays on an electro-mechanical old-style teleprinter and, finally for a Morse key.

So, power up. A great hash of white noise on the receiver audio, and little else. In fact, tuning round the bands, only the most powerful of the broadcast stations, like BBC World Service, was audible. Could it be the neon strip lighting in the office? They were all turned off but the hash remained.

The antenna was taped to a window pointing towards north London; the building was old enough not to have a steel frame, so from where was the noise coming? Answer — the Pet.

Micros need high-speed oscillators to drive their clocks and such oscillators are radio frequency transmitters, operating usually on a number of harmonics as well as a fundamental. In addition, the VDU needs a time-base and you can hear that also, on a receiver. My antenna was all of one metre above the Pet.

## Case asset

Radio Frequency Interference — RFI — is a serious problem for the micro/radio enthusiast. In later experiments I was able to tune my receiver around to pick up the various activities of the Pet. In fact, as I executed the usual clutch of commands, I could hear changes in the audio signal. These changes were not audible, as one might suspect, simply when a cassette program was being loaded; LIST and

RUN produced characteristic changes in signal.

As it transpires, the Pet is not particularly bad in this respect; its great asset is a metal case which acts as screen. Plastic-cased and open-PCB micros are much worse.

RFI works both ways, for the presence of high-voltage RF signals from a radio transmitter can also upset the micro. Such problems can be solved. Antenna need to be removed from the micro and the feed lines have to be coaxial and well-screened — balanced upon feeders are a definite mistake. All power lines should contain the same kind of filtering recommended for hi-fi equipment used near a radio transmitter.

All audio lines between a micro and a transceiver should be screened, should be as short as possible, and preferably should contain RF traps of standard design, since it is only audio in which the M-65 and similar units are interested. As far as possible all units which either emit RF or could pick it up should be encased in metal. Those requirements are much less horrifying in practice than when set down baldly on paper.

## Home solution

Abandoning the idea of Composite Signals Receiving Station (Temporary Location), I moved activity to my home.

Partial solutions to many of the problems indicated manifested themselves gradually, though in the special conditions of equipment review when the goodies have to be returned reasonably intact, perfection was not achieved. Moreover, as my receiver began to produce signals in the way to which I was accustomed and the possibility of having something for the micro to decode loomed on the horizon, another set of difficulties presented themselves.

Amateur radio gear differs from domestic receivers and that produced for military and diplomatic professionals by its multiplicity of knobs. The controls are there to enable you to peak-up various resonant circuits. The domestic receiver has none of them and the professionals have it all done for them almost automatically. Simply to peak-up my modest FRG-7 it is necessary to fix megahertz band, tune and perhaps fine-tune kilohertz knob, peak-up pre-selector, and select transmission mode.

Using a passive antenna, there are two further controls to peak-up its electrical length. After that, there may also be a degree of audio filtering to remove extraneous noise.

Most radio signals, other than very local ones, tend to vary and drift, depending on atmospheric conditions, the stability of the other person's transmitter,

and the sudden appearance of third-source signals.

The M-65 will accept audio signals only of a specific frequency. It is necessary to do this so that the internal logic isn't confused with a multiplicity of noise. The audio is captured by a phase-locked loop (PLL). If there are to be any results at all the radio operator has to deliver the correct audio frequency by adjusting the tuning of his receiver. It would be feasible to design an automatic frequency control (AFC) circuit which would do this, but if there were two signals close to each other — a fairly frequent occurrence — the AFC might be confused and capture first one, and then the other. It is possible to adjust the acceptance frequency of the M-65 by playing with the PLL, but it is not recommended.

## Valuable addition

The micro/receiver arrangement can be made to work, though by this stage it was significant that when I had seen the system demonstrated a few months earlier, all that was being decoded was a hand-key plugged directly into the M-65 board.

As supplied, the review sample fell far short of what I would like to set up on a permanent basis. No real blame can be attached to the supplier and my results convinced me that the system works and is a valuable addition to any station. But I would recommend purchasers to seal the board in a metal case, to locate the LED tuning indicator as close as possible to the receiver, and to replace all the leads with screened audio cable. An RF trap between the receiver and the board and the usual precautions on all power cables should decrease RFI considerably.

Because of RFI and ergonomic problems I found it more convenient to record samples of Morse and RTTY on tape — I listened to commercial as well as amateur traffic — and then fed them afterwards into the M-65 and Pet. The software will accept Morse at anything between one and 100 words per minute, though you have to fix the speed by keyboard command to within  $\pm 10$ wpm, which is not difficult to gauge.

A dedicated Morse encoder/decoder, the Xiter, will track any speed of up to 150 wpm and display the speed as it does so. Most auto decoding devices respond badly to badly-sent Morse, as one might expect.

## Encoding easy

Encoding Morse on the M-65 was easy; it is a matter of typing-in text on the micro keyboard. The current software has a forward buffer of only 10 characters, which means that typing and transmission can get out of step, with characters lost if you are not careful. In addition, a

LETTERS	↑	FIGURES
A	••••	—
B	••••	?
C	••••	: ?
D	••••	WHO ARE YOU
E	••••	3
F	••••	OPTIONAL
G	••••	OPTIONAL
H	••••	OPTIONAL
I	••••	8
J	••••	BELL
K	••••	(
L	••••	)
M	••••	.
N	••••	,
O	••••	9
P	••••	0
Q	••••	1
R	••••	4
S	••••	'
T	••••	5
U	••••	7
V	••••	=
W	••••	2
X	••••	/
Y	••••	6
Z	••••	+
CARRIAGE RETURN	••	CARRIAGE RETURN
LINE FEED	••	LINE FEED
LETTERS	••••••	LETTERS
FIGURES	••••••	FIGURES
SPACE	••	SPACE
LTRS	TAPE	FIGS

International Telegraph Alphabet No. 2.

character is displayed only as it is sent, not when it is typed, so errors are not always easy to detect. There are 10 message stores, giving a maximum of 2,550 characters, so a good deal of routine information can be pre-prepared. The other side of the cassette gives RTTY. Typing 'live' in RTTY is much more difficult, because the ear cannot act as a check for the progress of the message in the same way.

In any case, the standard method of the old 'hardware' approach to RTTY is to pre-prepare a paper tape, as with Telex on the telephone lines. Thus in the RTTY mode, the message stores become essential.

A de luxe version, the M-650, soon to be available in the U.K., overcomes many of these objections. In effect, it splits the VDU into three areas to give a displayed

Macrotonics Ham Interface, including software cassette and documentation		
for 8K Pet	assembled & tested	£61.76
	kit	£47.92
for 16K & 32K Pet	assembled & tested	£67
	kit	£53
for TRS-80	assembled & tested	£82.52
	kit	£66.55
All prices include VAT and postage from Nicomtech, 212 St Stephens Road, Saltash, Cornwall PL12 4NL.		

transmit buffer, a displayed receive buffer, and an indication over two lines of what is being sent over the air.

There is also a Morse practice facility,

which generates either random characters in groups of five, or five-letter words — ideal for preparing for the Post Office Morse test. It works with relentless efficiency.

To become a radio amateur, a Home Office licence is required if you wish to transmit. The present cost is £6.40 pa and you need to have passed the Radio Amateurs' Examination, set by City and Guilds, which should present no problems to those of average intelligence and determination.

That gives you the right to transmit in a number of bands from VHF (144 MHz — 2 metres) through UHF to microwave in a variety of modes, including data, provided that the bandwidth used does not exceed that normally used for speech — about 3KHz.

If you wish to go to the short-wave bands a Morse test at 12 wpm is also required.

## Oddities

There are special frequency allocations for amateurs. One of the oddities of the situation is that although Morse can now be generated and decoded automatically, a proper examination pass using a straight key is needed before you can put it on the air-waves.

Most amateurs at one time or another join the Radio Society of Great Britain (RSGB) 35 Doughty Street, London WC1N 2AE. The annual subscription, now £10, brings the monthly magazine *Radio Communication*, which has articles on micros from time to time.

Two American magazines worth watching are *Ham Radio* and, when it is obtainable, *73*, which is very micro-orientated.

The RSGB publishes a booklet *A Guide to Amateur Radio* — (£1.71 including postage from RSGB) — and many specialised texts. Its American counterpart, *ARRL*, has a particularly high standard of publication. Neither has yet produced anything on micros and radio.

There is, however, *Amateur Micro-computer Newsletter*, at the moment supplied free by a well-known amateur, Graham Knight GM8FXX, who is also a Nascom dealer. His address is 108 Rosemount Place, Aberdeen, Scotland.

## Where to buy

At the time of writing the only dealer to specialise in micros and amateur applications is Nicomtech, run by Nigel Huntley, G4CDU, whose address is 212 St Stephens Road, Saltash, Cornwall.

A number of the big amateur radio dealers are opening micro departments, including Lowe of Matlock, Radio Shack of West Hampstead, and South Midland Communications of Southampton. □

# Data on the air

AT LEAST two methods of data transmission have been available for many years. One is Morse code; the other, a somewhat later development, is Radio Teletype, usually abbreviated to RTTY. Both systems lend themselves very easily to microprocessor control and signal derivation; programs for both are written easily — particularly Morse. Alternatively, commercial programs can be purchased for most types of micro-computer systems.

FSK and AFSK and other methods of data transmission can be super-imposed on the radio frequency carrier in a number of ways. As these forms of modulation are, in general, common to all forms of data transmission, it is as well to look briefly at some of them.

The simplest mode of transmitting Morse code over a radio system is to switch on and off the RF carrier in the appropriate patterns. Thinking in digital terms, we could perhaps consider Morse 'dots' as a simple 1, and 'dashes' as 11; spaces between dots and dashes could be represented by 0 and spaces between letters could be seen as 00.

## Straightforward

Thus the character '.' could be sent as '00110100', including spaces at each end. In our simple interrupted carrier mode of operation, we consider the 0s as 'carrier off' and the 1s as 'carrier on' — very straightforward and incredibly simple.

As an alternative, we could have the carrier 'up' all the time and switch its frequency by a pre-determined amount. This is referred to as FSK or Frequency-shift Keying. If we think of the two frequencies as  $f_1$  and  $f_2$ , with Morse we could send 0 as  $f_1$  and 1s as  $f_2$ .

As an alternative, we could keep the carrier up all the time and impose an audio tone on it — via either frequency or amplitude modulation — and interrupt the tone to represent 0 and 1. This is satisfactory, except that it is subject to errors due to interference, which could confuse tone or the lack of it and thus reduce intelligibility.

A useful alternative, therefore, is to use two tones, one to represent 0 and the other 1. This is known as AFSK, or, sensibly enough, Audio Frequency-Shift Keying. Both FSK and AFSK are standard methods for sending both Morse and RTTY over the air.

The transceiver hardware required to

**Richard Elen, G8RJX, looks at the possibilities available for MPU-based amateur radio data transmission.**

interface a micro in either mode is one or two software-controlled tone generators and, on the receive side, a pair of audio-tuned circuits to pick out the tones received and convert them to logic pulses for decoding.

There are internationally-agreed amateur and commercial standards as regards the frequency shifts for FSK and the tones for AFSK. Amateur RTTY, interfaced originally, of course, with mechanical Teletype units, uses a number of standard baud rates — often slow in computer terms — to facilitate sync with the mechanical governors used in such machines.

The elegance of radio data transmission lies in the fact that the hardware needed to add to your computer and transceiver is minimal, leaving you to concentrate more on the exciting possibilities of software to derive the appropriate mode of

transmission you want to use.

Thoughts of AFSK, of course, lead us to think about the fact the most of our microcomputers already provide an AFSK-type output — the cassette interface. Why not hook your computer to a transceiver via the cassette interface and type away — given an amateur licence? There is, of course, no reason why you should not. You could set up rather an elegant system whereby you type your message, enter SAVE, and then blast the message into the ether via an ordinary transceiver in any mode — AM or FM — you wish.

A little more software and you could route the keyboard straight to the interface and type vigorously in real-time. Going even further, you could control the system by storing the message temporarily in RAM, clocking it out in short data

bursts, switching the transmitter on for the burst and 'resting' in receive mode between times.

That way, a station to which you are talking could 'break-in' or interrupt during the receive part of the cycle, activating the interrupt line on your MPU and bringing-in a secondary interrupt program to decode the message being returned to you. That would facilitate a very fast interchange of information — at least as fast as you could type. Very elegant.

## Language problem

There is a problem, though; very few micros talk the same language. Apart from the encoding of characters by your machine to be sent to the cassette port, there are so many standards for baud-rates, tone frequencies and so on, that while your Pet could talk to your friend's Pet, and my ITT2020 could talk to your Apple II, could your friend's SWTP 6800 system talk to my ITT2020? I doubt it. Not without a good deal of fiddling. What is needed is a real standard for this type of data transmission; either an existing one, which should be adopted universally — Kansas City, perhaps, or something else — or an entirely new one which does the job and which everyone can agree is satisfactory.

Another option is to use a suitable terminal interface system like RS232 and encode it with tones of an agreeable standard. The point is that, at present, there is no agreeable standard.

There is a standard being offered for amateur use but it is a little more complex than we have so far discussed. In the meantime, you can talk to people who have the same hardware as yourself. If

Figure 1. Block diagram of a multi-standard transceiver interface unit.

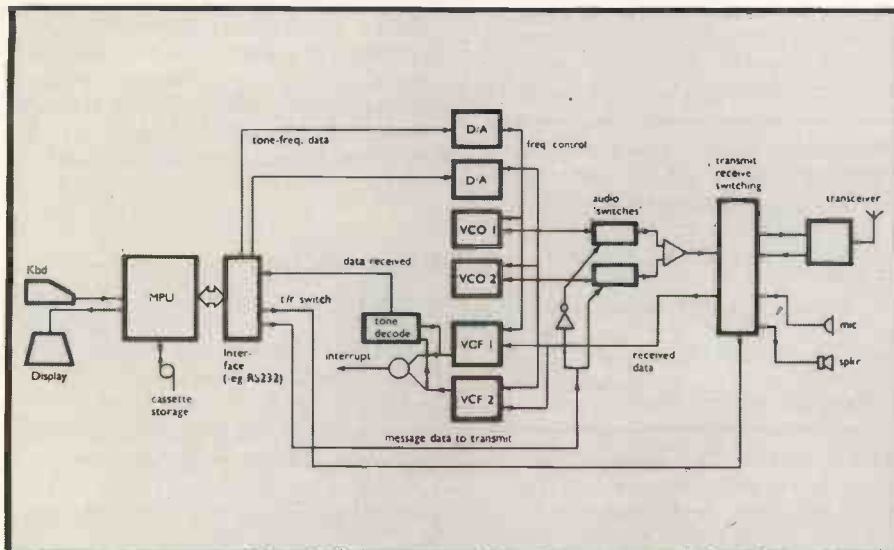



you feel more adventurous you could, no doubt, utilise a program and a bit of hardware which would load the message blocks into RAM, from whatever source you like, and clock them out, at a software-determined baud-rate, into an AFSK encode/decode unit containing a pair of software-controlled, voltage-controlled oscillators and audio filters whose frequencies are determined by the output of a D/A converter or two.

Add a bit of switching and level/impedance matching to cope with the possibility of switching a microphone and speaker into the system to talk direct, and a cassette recorder, if desired, to record messages for reference or store a standard CQ call or whatever for transmission, and away you go (see figure 1).

## Normal contact

Contact can be established via the microphone in the normal way and you can then decide what standard — tone frequencies and baud rates — you will use. When a real standard AFSK interface arrives your box will have to convert your own micro standard to that used for transmission and you can dispense with the VCOs and DAs.

The problem with any system of this nature, before an agreed standard is introduced, is that you have to make the initial contact by telephone. That would be a severe disadvantage when trying to communicate over long distances or in difficult conditions.

This is particularly noticeable with 'interrupted carrier' Morse transmissions, known by amateurs as CW, an abbreviation for Continuous Wave. A CW signal is copied simply by beating the interrupted carrier with an oscillator in the receiver, called appropriately a BFO or Beat Frequency Oscillator, to produce a well-

defined audio tone.

Contact is possible over very difficult paths in this manner because the operator has to listen for the pattern of audio dots, dashes and spaces. In the same way, a data transmission, consisting of a more complex digital pattern, will be recognised by your equipment far more readily than a variable signal like a voice. There may be the odd error but at least you will have something useful unless conditions are really disastrous.

descriptive article in the August, 1979 issue of the RSGB magazine *Radio Communication*.

In brief, the system is based on a master/slave relationship between the stations in touch with each other. The master station sends three characters of message, after which the slave returns a control character corresponding to characters received or not received. A third control character is used during the change-over of master and slave at the end

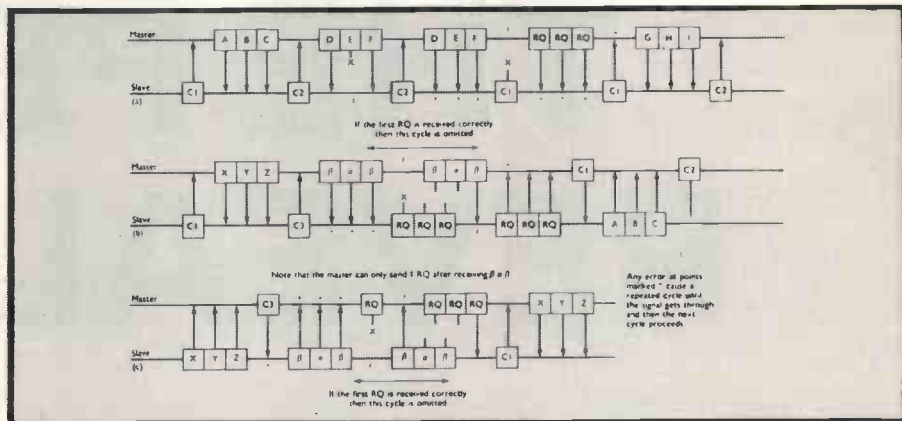

Figure 2. (a) Master sending to slave, with errors; (b) change-over from master to slave sending; (c) change-over from slave to master sending.

This leads the way to developing a beautifully-elegant transmission system in which blocks of data are sent and acknowledged if copied at the other end, or repeated if not.

Such a system had been proposed and is already in use by some amateurs. Called AMTOR — Amateur Microprocessor Transmission Over Radio — it has been developed from commercial systems based on CCIR Recommendation 476, by two amateurs, J P Martinez, G3PLX, and Dave Wicks, G3YYD. The former, who has already done pioneering work on MPU applications for RTTY, published a

of an 'over', and a further three characters referred to as RQ — Repeat Request — Alpha and Beta are also utilised in error-correction and change-over.

The standard teleprinter codes and other characters are translated into a seven-bit digital code with four 1s and three 0s, so an error is detected easily by checking the number of zeros in a character received. A seven-bit code, of course, offers 128 possible variations but as only 32 are recognised as characters, this offers further error-correction possibilities. There are 35 possible variations of a seven-bit code with three 0s and the three which are not teleprinter characters are used as the RQ, Alpha and Beta characters.

Table 1. Translation of CCIR 476 code to standard teleprinter characters. The codes are transmitted right-hand bit first, and logic 1 corresponds to the higher of the two radiated rf frequencies in the frequency-shift-keyed signal.

Amtor code	Letters	Figures	Amtor code	Letters	Figures
100 0111	A	—	100 1110	U	7
111 0010	B	?	011 1100	V	=
001 1101	C	:	010 0111	W	2
101 0011	D	wru	011 1010	X	/
101 0110	E	3	010 1011	Y	6
001 1011	F	%	110 0011	Z	+
011 0101	G		111 1000	carriage return	
110 1001	H	£	110 1100	line feed	
100 1101	I	8	101 1010	letter shift	
001 0111	J	bell	011 0110	figure shift	
001 1110	K	(	101 1100	space	
110 0101	L	)	110 1010	blank	
011 1001	M	.			
101 1001	N		110 0110	RQ	
111 0001	O	9	011 0011	beta	
010 1101	P	0	000 1111	alpha	
010 1110	Q	1			
101 0101	R	4	110 0101	Control 1	
100 1011	S	'	110 1010	Control 2	
111 0100	T	5	101 1001	Control 3	

## Control signals

Control signals 1, 2 and 3 duplicate some of the teleprinter character codes but as controls are sent only in the reverse direction to the actual message, there is no possibility of confusing them.

Figure 2 shows an example of how these codes are utilised in practice while table 1 indicates the seven-bit codes used by AMTOR. G3PLX and G3YYD have used this system in the 144MHz band over a 200km path with 10dB gain antennae and 10W, and reckon that AMTOR has transformed contacts from being practicable on about 50 percent of attempts to 100 percent. The message speed slows below typing speed when conditions are very poor indeed.

**ESSENTIAL READING FOR ALL PET USERS**

# THE PET REVEALED

*ALMOST 260 PAGES OF SOLID INFORMATION FEATURING:*

PET circuit diagrams — How to use the diagnostic routine — PET ROM subroutines and their entry points — Programming in machine code — Using the IEEE and User Ports — Double-density graphics — Uncopyable programs — Page zero locations and their uses — A TRACE program for Basic program debugging — Disabling the keyboard and/or the Stop key — Adding a repeat key — Line re-numbering — Auto line erasing — Making the PET write its own programs — Printer interfaces — Adding new commands to Basic — Interrupts and multiprocessing.  
Plus many more fascinating facts about the PET.



**commodore** APPROVED PUBLICATION

*Send cheque for £10.00 made payable to Practical Computing.*

**PRACTICAL COMPUTING**

**DORSET HOUSE, STAMFORD STREET, LONDON, S.E.1.**

• Circle No. 186



## Rair Black Box has many virtues

PROFESSIONAL is a term used all too frequently in the field of microcomputers. The Rair Black Box microcomputer has been around for about two years and one of its claims is that it is a professional system with good support. It was refreshing, therefore, to find that Rair in London took what appeared to be a responsible attitude, when I was asked to review it. Rair was the first supplier to suggest that I had a showroom demonstration of this equipment, to avoid any possible difficulty in the use of the computer when it was delivered.

### Equipment

The Black Box is a complete diskette-based microcomputer system using the Intel 8085A running at 3MHz. It is configured with memory in 16Kbyte blocks. The version delivered had 64K of RAM.

The operating system supplied as standard has the *de facto* microcomputer standard disc system, CP/M.

Two minifloppy diskette drives (5¼in.) are built into the computer box. This is the minimum number of drives supplied but the system is capable of supporting up to four drives. The recording standard is the IBM soft-sectored format; the version for review had single-density recording of up to 80Kbytes storage capacity. Double-density recording format is available as an option.

### In use

To start up, the Black Box requires the connection of a VDU and powering-on. In theory it should be as simple as that. The terminal delivered with the system was a Rair VDU — a Hazeltine 1410.

On connecting the cable and powering-on, not very much happened. The cursor on the screen remained in the top left-hand corner and that was all. Neither did the disc drives boot-up as shown in the demonstration. The Load button was depressed, drive A became alive, and a

few meaningless characters appeared on the screen. This suggested there might be a baud rate mismatch.

by Vincent Tseng

few meaningless characters appeared on the screen. This suggested there might be a baud rate mismatch.

Remembering that the Black Box runs at 9,600 baud, which I was told in a letter sent with the review equipment, I thumbed through the Hazeltine VDU manual and found how to set up the baud rate.

Powering-on, the disc drives again remained inert but on Load that time, CP/M identified itself and displayed its prompt on the screen. All seemed well, but not completely. Typing on the keyboard produced nothing on the screen and no apparent reaction from the computer.

The RS232C cable was checked and

### Dependence

As the Hazeltine VDU had the conventional pinning, I can assume only that the Black Box either has unconventional pinning, on pins 2 & 3 only, which could be awkward when connecting a VDU if that is not apparent, or the version for test had a wiring mistake to the serial socket.

There was some difficulty delivering a review machine, and in the process it had no CP/M system disc. The other discs can be loaded under CP/M but lacked the various system utilities. That illustrates how dependent on discs the machine is, since there is no monitor to work without discs, and without a disc the system is silent.

A full CP/M system disc was sent quickly. A worthwhile note is the importance of copying and backing-up the CP/M system disc, in case of accidents.

Even with the CP/M system disc, the computer still did not load on powering-on, and throughout the test it was necessary to use the Load button to start the

(continued on next page)

(continued from previous page)

system. As there is supposed to be a power-re-set with an automatic boot load from disc drive. A the review equipment probably had a fault in the power-on-reset circuitry, in the firmware bootstrap or in the re-start jump address to it. That did not affect the operation of the system it was not pursued.

## CP/M operating system

To the user who does not wish to write machine code, a computer running CP/M is almost invisible, and the user deals directly with the operating system. I found that CP/M was easy to pick up, perhaps because it bore some resemblance the Digital Equipment mini systems with which I am familiar. The facilities offered were the proper ones for a disc-based computer, and although it may not be the best operating system in the world, it is certainly more than adequate.

One of the most useful facilities is the ability to create user's own command files by the use of Submit. The Dir — directory-command — was no more than adequate, since it gave only the names of the files on the disc concerned, with no other information. A better method to use would be "STAT \*.\*" which would give not only the file names but also the sizes and the amount of free space remaining.

Files have no particular attributes — they cannot be write-protected, or individually made "invisible", so that they are not listed-out on a directory command — useful for security of files — or declared as a system file, so that they are copied across automatically on formatting a new disc to be a system disc. Those may be minor points in a home environment but could be crucial for a business application.

The useful Submit command can have external parameters so that versatile user command files can be created. One of those tried was to be able to format a new disc and then copy all the files from the disc in drive A to drive B — a disc back-up command.

## File extensions

Admittedly this was really trivial and to do it step by step using the already-available commands would not have taken much longer, but it was a useful exercise. The Submit command, however, did not seem to like a Format strung together with a PIP and it would not work. Using Format alone in a submit command, however, does work, which seems strange.

All file interchanges were via the PIP — Peripheral Interchange Program — command. PIP allowed versatile interconnections, such as reading-in from an external device, so long as it is a device recognised in the CP/M repertoire — a paper tape reader or the console keyboard



Vincent Tseng gets to grips with the Black Box.

straight into a disc file; or from one device to another — the VDU keyboard on to a printer.

In CP/M, files have an eight-letter name, with a three-letter extension which indicates the file type. For instance, all files created by a program in Basic will take the default extension 'BAS'.

File extensions are used to identify the file type for the various compilers supplied and for certain commands. Any extension could be tagged on to any type of file, since the file type was checked only on calling-up the file for use. The extension were also useful as reminders of the file type for the user.

Other CP/M facilities were a text editor "ED" which operated in a fairly basic way but included a string search command "F". There was no line-numbering in the editor. "DDT" is a Dynamic Debugging Technique, a powerful machine-code monitor which included single step and trace, automatic single step and trace to a pre-specified number of steps, and breakpoint setting. There is a single-line direct assembler or mnemonic entry of code, as well as a disassembler for mnemonic display of code in memory. "DDT" is useful for development of further system facilities, or for control programs where timing is important.

There were no line-editing facilities, other than on the current — unentered — line. Once a line is entered there are no facilities to recall the line and modify it, or to repeat the command.

## Software

The Black Box claims extensive software support. Supplied with the test equipment were minifloppy discs with Fortran, Cobol and the expected Basic called MBasic.

The virtue of CP/M is that the machine

can run any of the extensive CP/M software library, which now runs to 40 full diskettes. It is distributed by LP Enterprises of 313 Kingston Road, Ilford, Essex IG1 1PJ.

MBasic is by Microsoft and has an edit command allowing editing by line number. Benchmark runs indicate that this Basic is the same speed class as the Research Machines 380-Z, and slightly faster than the Pet and Apple Extended Basic.

Fortran-80, again by Microsoft, is claimed to be to ANSI 1966 standard with a few extensions added. The compiler seems efficient in compilation time, taking about 22 seconds to compile a 30-line Fortran source, and in the process generated approximately 473 bytes of machine code.

The listings file was good; it gave the Fortran source line statement numbers, listed them and then listed directly underneath the statement concerned the mnemonics of the generated machine code. This type of listing is helpful when debugging a program using "DDT".

## Linking loader

There is a linking loader program and a Fortran library for routines and functions. L80, the linking loader program, needed slightly more than one minute to link in the library to the above program, which had referenced 19 external calls to the library, and to load the executable code into memory. The memory image can be kept by using the "SAVE" command in the CP/M utilities, giving the saved file the extension of ".COM" for command, so that CP/M will recognise it as an executable file.

Cobol-80, by Microsoft again, is said to be to ANS-74 standards. It worked in a

similar way to the Fortran compiler. A Cobol source file may be created using the CP/M text editor, be given the extension of ".COB", and then submitted for compilation.

## Linking loader

The compiler had further overlays and needed approximately one minute to compile 55-lines of source code. Unlike the Fortran compiler, the listing file generated only added line numbers to the source code and there was no display of machine mnemonics, and any indication of program size or external routines referenced.

This type of listing is of little use, except for when there are compile time errors, but once the compile errors are eliminated, one may as well have hand-numbered the source statements. The linking loader is also called L80 and is identical to the one supplied with Fortran. It needed slightly more than one minute to link in the routines from the Cobol library and to load the executable code into memory, for a program with machine-code size of just less than 10Kbytes. Again, the code can be kept as a ".COM" file using the "SAVE" command.

Using the compilers revealed the limited capacity of minifloppy discs. For example, there was not enough room on a CP/M system diskette with all the standard utilities and for either of the compilers with its library files and the

linking loader. It is therefore fussy to work with the compilers, since one has to change discs after editing or creating a file. Double-density recording format would probably be a better proposition for more serious use but even that at about 160Kbytes/drive, is only just adequate.

## Documentation

Each of the software systems had its own manual. Both the compilers' manuals were brief and to the point and were useful for reference. The CP/M manual was again brief but good, and helpful for those who needed to learn how to use the system as well as being a reference manual.

The MBasic manual is similar but not so good as CP/M. There was no hardware manual supplied. Rair does not supply one usually. At least it could supply a trouble-shooting guide, which should list standard procedures to be tried in the event of problems. This could save time to both customers and Rair in solving some of the more minor problems, as well as giving the user more confidence. Omitted also was any setting-up and getting-started notes; for instance simple instructions on connecting peripherals, making sure that signals and baud rates match. Admittedly, Rair gives potential customers demonstrations at its London showrooms, which is to be applauded, but a note for future reference is always useful.

## Hardware

Inside, the Black Box looked neat and tidy. There were only four cards in the 8-slot motherboard. The cards had 86 pins and were not to the S-100 bus standard. There were the CPU card with the 8085A and an 8257 DMA controller, a floppy disc drive controller card, a memory card with 64Kbytes of 4116 dynamic RAMs, and a communications interface card with two UARTs. There was no parallel I/O catered for and the option is not listed in the price list.

## Conclusions

- I liked the Black Box. It offers the proper kind of facilities for a small computer. The main criticism is the low capacity of the minifloppy discs — this is common for minifloppies recording on single-density format and not exceptional to Rair.
- All the software systems worked well and CP/M is a good choice as the operating system. The listing file of Cobol could be improved. I hope Rair will re-consider its policy regarding the supply of hardware manuals, or at least give a trouble-shooting guide as well as setting/connecting instructions.
- The responsible attitude to its equipment deserves praise. Rair was able to offer me four reference sales, as well as applications sold by other companies using the Black Box as the equipment, to support these claims. □

## Practical Computing evaluation

	Yes/No NA	1	2	3	4	5
Ease of construction (where applicable)	N/A					
Quality of documentation				✓		
Dealer support/maintenance						✓
Can handle 32K of memory	YES					
Quality of video monitor (consider resolution and screen size)	N/A					
SS-50 Bus	NO					
S-100 Bus	NO					
Socket for chips	YES					
Numeric, calculator-type pad on keyboard	N/A					
Large amount of removable memory, randomly accessible	YES					
Cassette tape recorder capability: Own	NO					
Built-in recorder	NO					
Communications capability (can talk to other computers)	YES					
Speed of instruction cycle	✓					
Ease of expansion			✓			
Low power consumption	?					
Assembly language	YES					
Basic language	YES			✓		
Other languages	YES				✓	
Compatibility with other systems	NO					
Reputation of manufacturer						✓
Appearance						✓
Portability			✓			
No. of software applications packages available						✓
Hobby use						✓
Business use					✓	
Educational use					✓	
Suitability for: Commercial applications					✓	
Home applications					✓	
Educational applications					✓	
Ability to add printer(s)	YES					
Ability to add discs	YES					
Ability to add other manufacturers' plug-in memory						
<b>Ratings</b> 1 = poor; 2 = fair; 3 = average; 4 = good; 5 = excellent. N/A = not applicable.						

# Tecs the system if you want to be a pioneer

REVIEWING the Tecs system has proved a nostalgic experience. When we started looking at micro-based computer systems 18 months to two years ago we were more concerned with the potential of the system than its immediate capabilities. We expected the documentation then to be incomplete, the software to be a preliminary release — full of bugs — and some hardware capabilities to be “available shortly”.

The challenging part of the review was to assess the capability of the system when it was fully developed, which was likely to be at least six months in the future.

Micro systems have grown-up quickly. We are not impressed now by sophisticated hardware and system software but look also for good documentation, application programs, and hardware and software support. The Tecs system we had for review seemed like the early micro systems because, despite it not being fully developed — and this is particularly true of the Software — it offers a very exciting new application in linking viewdata and Teletext with low-cost computing.

Tecs is “a micro-processor-based Teletex/viewdata recorder with powerful local computing facilities”. The Tecs is two separate systems based on a common microprocessor:

- Teletext/viewdata receiver;
- A 6800 microcomputer.

The system is housed in a low cabinet similar to that used by the Sol computer.

The keyboard, which follows the Post Office preferred layout, contains normal QWERTY keys together with a numeric pad and, optionally, the function keys required for editing data on Prestel. Taking the top off the box reveals two sets of boards; on the left-hand side are those required for interfacing to Teletext and viewdata and on the right-hand side are the 6800 processor, memory, and I/O controllers for the computer peripherals.

The system which we had for review

processor card which contains the 6800, 4K RAM, an RS232 interface and 4K PROM. The next slot was occupied by the Prestel card which contained the modem interface and 1K PROM containing the software required for handling the Prestel data.

That left four spare slots which could be occupied by the following boards:

General purpose interface card which occupies two slots and provides: RS232 interface; floppy disc controller; Kansas

**Last month we devoted space to Teletext and computing. At the moment there is only one, or almost, one machine capable of using the computing facilities offered by Teletext/viewdata. Martin Collins looks at the TECS system and finds some ‘under construction’ signs.**

had the following components on the left-hand side:

Modem, for interfacing via a Post Office telephone to Prestel. This uses the Datel 1200 service which gives 1,200 baud transmission from the Prestel system and 75 baud to it.

Teletext Reception Card/Teletext Display Board, used for displaying both Teletext and viewdata as they use common formats.

TV interface card, which outputs the display to a normal television set and allows software control of TV channel change.

On the right-hand side were the computer cards, plugged into a Tecs bus. The bottom slot was occupied by the

City cassette interface; 4-bit audio interface; two parallel ports and 240-byte bootstrap in ROM.

Memory board which can hold 16, 22 or 48K RAM with 8K, PROM or 56K RAM.

That leaves one spare slot for further expansion.

Technologies chose the 6800 for the system because at the time when the original development was undertaken it was found to be faster than the 8080 for the Teletext software and the Z80 was too new and expensive to be considered as an alternative.

That limits the range of “standard” software available, as the 6800 has lagged behind the 8080 in popularity and therefore in available software.

The software now available is an editor/assembler and two versions of Basic, 3K and 8K. A special feature of both those versions of Basic is that they provide full Teletext colour display functions which allow 24 rows of characters, cursor control, six colours, double-height characters, 80 x 72 resolution graphics in black and white or colour, and any mixture of graphics and characters.

The 2K Basic is a “tiny” Basic with integer arithmetic and 26 variable names. The 8K Basic provides floating-point arithmetic and the normal range of functions. The only disc software available allows display pages to be saved and loaded. Technologies have not decided whether to adopt one of the standard 6800 operating systems or to develop its own.

The system also contains a monitor in PROM which can be used for machine-code programming; that, as is traditional on 6800 systems, is called TECBUG. Finally, the Teletext information is

## Telesoftware from the CAP'GPP group

Telesoftware puts computer programs into the viewdata set.

Special intelligent viewdata sets can function as computers. The programs for these can be stored & retrieved as normal viewdata pages.

These programs could be specialist programs, for closed user groups, or general programs for domestic users.

An example of a telesoftware program is on page 30206, frames a'd (2p each)  
key 0

For more on telesoftware key -

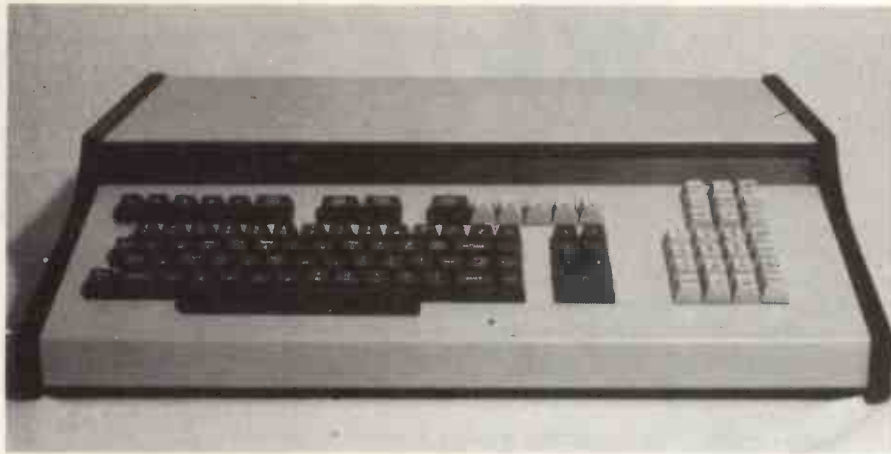

**TECS system box and keyboard. Also needed are a TV set, printer and, at some time, floppy discs.**

displayed from 1K RAM which can be addressed by any program and this allows further processing of information extracted from Teletext or viewdata. Under development are Pascal, Microcobol and Pilot compilers.

The Tecs system obviously can be used either as a Teletext receiver or as a stand-alone computer system but its real

### Configurations and costs

The system is available as a kit or assembled. Some possible configurations are:

	Kit	Built
Teletext system with 3K Basic and 4K RAM	£895	£1,175
As above, with Monitor		
8K Basic and 16K RAM	£1,335	£1,635
Teletext and viewdata system with 2K Basic and 4K RAM	£1,595	£1,995
With sample add-on costs as follows:		
32K RAM	£1,435	£1,735
General purpose interface card with 1 RS232C, 2 cassette ports 2 parallel ports, and Audio OUT	£130	£160
Floppy disc drive with controller card		
Software	£490	£500

potential must lie in combining those capabilities. It could therefore be used to prepare information to be entered into Prestel — that would interest people who supply information, known as Information Providers; store and process information extracted from Prestel/Teletext; run programs extracted from Prestel/Teletext. This is known as telesoftware.

### Limitations

As an editing system for an IP the system has some limitations, for example, the lack of a comprehensive disc operating system, but as this is obviously the most important initial market for the system, Tecs is putting most of its software development effort into this area, and the deficiencies should soon be eliminated.

The second area of use, storing and processing information extracted from

Prestel/Teletext, is a little more difficult to define. One important difference between the two services is that while Teletext is free, Prestel is not. Prestel charges are based on an amount per page displayed — this can be from ½p upwards and 15p is not uncommon plus the cost of a telephone call.

As anyone who has ever used a time-sharing system knows, it is very difficult to control those kind of charges — they mount at an alarming rate.

Information is located in the Prestel system by working through a series of directories until the detail required is reached. There is a charge for each directory page, so using the Tecs system to store the directory structure, or the identity of the detailed page, would reduce the costs of accessing the data. That would work only if you knew what you wanted to look at and if the information structure remained stable.

### Conclusions

- It is interesting to compare the capabilities of Tecs, Prestel and Teletext with a new, lost-cost, time-sharing service called the Source, which was launched at the NCC in New York in June.
- The Source provides off-peak, low-cost (\$2.75 per hour connect time) time-sharing. As well as programming in Basic, Fortran IV and Cobol, Source allows a user to access a wide variety of information, including the UPI data bank, entertainment and New York Stock Exchange information.
- The Post Office Prestel service clearly was designed for the dissemination of information in a visual form and teletext.
- Because of their graphic and colour display capabilities, Prestel/Teletext are better at presenting visual information than the Source. On the other hand, the Source looks as if it will provide a much more effective blend of information service and computing.
- With the exception of the requirements of the IPs, there are no fully-developed ways of combining the Prestel/Teletext capabilities of the Tecs system with its computing power. There are obviously many ways in which they can be combined in the future and the Tecs system is an excellent basis for developing software to link the two areas.
- At present there are no other small systems which provide the same capabilities as the Tecs system. There is development work being done on a Prestel peripheral for the Apple but we have no information on when it will be available.
- In its present state Tecs offers access to Prestel and Teletext, together with reasonable basic computing capabilities. On the computing side the major outstanding problem is the lack of a disc operating system, which hopefully Tecs will resolve by adopting one of the available 6800 operating systems. If you want to become a pioneer in linking Prestel/viewdata with microcomputing, Tecs is the system for you.

As far as storing information is concerned, the easiest way would be to attach a printer and print pages of information as required. Obviously only textual, as opposed to graphics, can be stored this way. The next step would be to store the information on a floppy disc for retrieval as required. To do this effectively, more comprehensive disc software than is available would be needed.

The Tecs system enables programs to access the 1K display buffer and therefore to process data extracted from Prestel/Teletext. One problem is that the pages of data are designed for visual presentation and so make use of the graphic display capabilities to maintain the user's interest. The format of the displayed information is unlikely to remain constant over a period and this will make it difficult to develop programs to extract and process the displayed data.

### Standards

The concept of telesoftware — the ability to obtain programs from Prestel/Teletext and execute them in the receiver — is relatively new and at present there is no telesoftware available for the Tecs system.

At first sight, telesoftware seems to be a good idea. The distribution of programs via a widely-used information utility seems to be attractive, but it raises at least as many problems as it solves. In particular, it requires a widely-accepted set of standards covering programming languages, transmission formats and, most important as far as the potential user of the Tecs system is concerned, the characteristics of the receiving system. Those standards do not exist.

MUCH microcomputer software is advertised by manufacturers and a number of microcomputers use the same processor. For example, the Cromemco systems have Basic, Fortran and a Z-80 macro assembler on mini-floppies at £85 each. They should be sold only to owners of Cromemco computers, and it is a breach of copyright to transfer them to other machines.

Should you attempt to do this illegally, you would be unlikely to succeed. Cromemco uses either IBM-format 8in. floppy discs or 5¼in. soft-sectored floppies and though the latter are the same size as on the Horizon, North Star discs are hard-sectored.

The discs look the same, except that the hard-sectored floppies have a series of 10 holes near the centre which mark the beginning of each sector; and since the North Star Horizon reads and writes information to the discs by sectors, it cannot use soft-sectored discs — which store information in concentric rings on the disc.

An additional complication is that the newer disc control boards may store information on the disc in single-density, double-density, or even quadruple-density formats. So ensure that the software you buy is stored on the correct size of disc, with hard or soft sectoring as required, and written at the appropriate density.

All general-purpose computers, as opposed to dedicated micro-processors, require a program called the operating system to allow interaction between input device(s) — keyboard, disc, cassette, or paper tape reader; the central processor unit and memory; and the output device(s) — printer, cathode ray tube, disc, cassette, or paper tape punch.

Until the operating system is loaded into memory and the CPU is set to read the program, the computer cannot function. The Horizon computer is provided with the North Star Disc Operating System, which supports North Star Basic. While this is a good, robust operating system, it supports few other languages — Pascal is on the way — and relatively few software packages are available to run under this system.

The first step in implementing software from other manufacturers is to replace the operating system by CP/M, a Control Program for Microcomputers, which was written by Digital Research.

## Becoming established

In much the same way as the S100 bus has become the *de facto* industry standard for hardware interfacing, CP/M is establishing itself as the standard operating system for microcomputers. A version of CP/M which has been adapted specially to run on any North Star disc system — the Horizon, or the Sol with North Star discs — costs £130 from The Byte Shop or \$145 from Lifeboat Associates in the U.S.

CP/M is supplied on a diskette and Horizon users must remove the case from their computer and re-locate the memory before attempting to use the diskette. For example, a Horizon with 24K of memory running North Star Basic has its memory (RAM) starting at address 2000 hex (8K) and continuing up to 8000 hex (32K).

CP/M requires that the switches on the memory board(s) be changed so that the RAM starts at address 0 and continues to 24K. Once you have made this change, on flicking the bootstrap switch CP/M is read from diskette into memory. CP/M is divided into four main parts:

- the basic input output system (BIOS).
- the basic disc operating system (BDOS).
- the console command processor (CGP).
- the transient program area (TAP).

BIOS is machine-dependent and so it is essential that this part has been tailored for a Horizon with hard-sectored minifloppy discs in single- or double-density as required. A consequence of the modification for North Star is that though CP/M is supplied and labelled as a 16K program, it needs 4K more than the nominal size — 20K of memory on a Horizon.

BDOS manages one or more disc drives which contain independent file directories and provides for dynamic file construction with the minimum movement of the disc-heads

# Wide range for H

across the disc. It can search for a named file, open or close the file, re-name it, or read or write information from or to it.

CCP allows the user to access various parts of the CP/M system by means of a set of built-in commands which list the file directory, type the contents of files, and save, re-name or erase files. The CCP also has a set of standard transient commands, which load and execute a named file which is part of the CP/M disc.

The working part of the memory used for these programs is called the transient program area. The fact that only the required parts of CP/M are held in memory at any given time is a simple

**John Lee wrote a user's eye view of the well-liked North Star Horizon microcomputer for our July issue. The Horizon does not stop short at the standard software offered with it by North Star. A wide range is now available from proprietary sources: Lee found several languages, systems, software text processing facilities and a range of applications software, including mailing lists, general ledger, accounts and database systems for storing and retrieving general information. Since most of these packages use the popular CP/M operating system, much of this will interest users of other computers too.**

and clever way of saving core. Supplied on the CP/M disc are the following standard transient programs:

ASM — an 8080 assembler.

DDT — dynamic debugging tool.

DUMP — file dumping program.

ED — text editor.

LOAD — a hexadecimal loader.

NSYSGEN — produces a new disc copy of CP/M either from an existing disc copy or from the version of CP/M in memory.

NRELOC — used to change the size of CP/M to fit the available memory, i.e., to make the transient program area as large as possible. Remember that a 28K version of CP/M requires 32K on a Horizon.

STAT — assigns devices, gives statistical information about file storage, and reports the amount of free space on the disc.

PIP — copies, re-names and merges files.

SUBMIT — a batch mode utility.

In addition, CCP will load and execute any users' transient programs you have written or purchased. Examples of such users transient programs include Basic, Fortran, Cobol, word processing, accounts, data-bases and the like.

CP/M is undoubtedly a powerful and sophisticated operating system for micros. I have three minor criticisms. Firstly, it is a pity that the assembler has only 8080 mnemonics rather than the extended Z-80 set.

## Reasonably powerful

Secondly, I found the editor reasonably powerful but it was a little difficult to get used to it. It works by having an imaginary line pointer, and a second imaginary character pointer which may be moved along a line. If it showed with a flashing cursor on a VDU it would be satisfactory, but without it, it is easy to get lost with two imaginary pointers. I prefer an editor which allows you to find the appropriate line and then exchange character strings.

Thirdly, I found the CP/M editor manual difficult to follow. It



# is available Horizon

did not explain or clarify all my problems. It is well worth reading the manual for the Cromemco editor which explains the CP/M editor functions more fully. This manual can be obtained from LP Enterprises.

My version of CP/M — North Star, single-density, version 1.41 — appears to contain a bug. The transient program NRELOC was used to produce a 20K version of CP/M on my 24K Horizon. The version so produced claimed to be 20K but a check on the amount of free space indicated that it was only 3K bigger than the 16K version supplied. This proved to be disastrous to me, since I was trying to load CBASIC, which required a minimum of 20K. Lifeboat Associates proved to be friendly and helpful, and are working on it.

A powerful text processing program called TEX has been written by Digital Research to run under CP/M. It turns a Horizon with a Diablo printer into a sophisticated word processing machine for standard letters, reports or books.

Text is split automatically into pages of any specified size. They are numbered and may carry a heading. Paragraphs may be indented optionally and the spacing of a line may be adjusted to right-justify the lines. The various commands are inserted into the text file using the editor before running TEX. The cost is £55 from The Byte Shop (\$85 from the States).

Minor criticisms of TEX are that you are obliged to number pages at the bottom rather than having the option of top or bottom; and you cannot print two columns of text on a page without using scissors and glue.

## For word processing

The Electric Pencil is a word processing package and is produced by Michael Schrayner Software Inc in the U.S. at prices up to £300, depending on the computer and the printer used. It is debatably the best word processing system for microcomputers because it runs interactively. It will left- and right-justify typed lines, handle any paper size required, indent paragraphs, and number pages, as do a number of other word processors.

Unfortunately, there is a catch — money. You need a memory-mapped VDU board. Two which display 24 lines of 80 characters are the Imsai VIOC board at \$465 and Flash Rider II at \$320. The Processor Technology VM1 board, which displays 16 lines of 64 characters, is less expensive, and though it may still be available it is no longer being produced. A Diablo printer costs more than £2,000. This system is superb but it beyond the reach of hobbyists.

Digital Research also has an 8080 macro assembler, MAC. It includes the Z-80 library; it produces absolute hexadecimal output and a symbols file which may be used by another program, SID. That debugs and provides a symbolic display of memory labels and equated values. MAC and SID cost £65 and £55 respectively from The Byte Shop — \$100 and \$85 direct from the U.S.

Another well-known U.S. software house, Microsoft, offers an interesting range of software for the Horizon. A new version of its Disc Extended Basic is claimed to be compatible with the minimal ANSI specification — earlier versions were not — and costs \$300.

The Fortran-80 compiler produces re-locatable object modules. A standard library of subroutines is supplied and you may also add your own. The compiler requires 24K plus the space for CP/M and provides all the features in the 1966 ANSI standard except for COMPLEX.

Microsoft also markets Cobol-80. It is based on the 1974 ANSI standard and contains all Level 1 features from the ANSI 1974

specification plus some Level 2 facilities. Cobol-80 consists of two parts, a compiler which produces re-locatable object code and a run-time system for interpreting the object code at execution time. The two occupy about 25K bytes, plus about 7K for CP/M plus about 12K for a 500-line program and the extra 4K needed by CP/M, giving a total of 48K. The price is £521 from Xitan in this country or \$625 from the U.S.

MACRO-80 is an assembler which dials with 8080 and Z-80 mnemonics. It produces re-locatable linkable output and together with utilities such as a loader, a cross-reference list and a library manager, costs \$149. Another version called MACRO-80 PLUS includes the Fortran library and costs \$219.

Xitan Disc Basic occupies 16K of memory and is a fast and powerful interactive interpreter which can open a large number of files dynamically for either serial or random input/output. It also has passwords for security. The price from Xitan in Southampton is £121 — \$159 from the U.S.

Super Basic occupies 12K and is a subset, but it does not have random access to files, and costs £76 or \$99 from the same sources. Xitan also markets ASM, a macro assembler designed for the 8080 but with Z-80 extensions (£53 or \$69); the Linker link-loader handles ASM modules for £53. Z-Bug is a debugger at £68 or \$69.

## Text editor

Xitan also sells Z-TEL, a text editor £53 or \$69. A text output processor called TOP, which creates page-numbered, right-justified documents from a source text file, is available only as part of a package: Z-TEL, TOP, ASM and Super Basic for £189, or Disc Basic, Z-TEL, TOP, ASM, Z-BUG and Linker for £311.

The Xitan Fortran IV sells for £286 in this country, which is cheaper than Microsoft Fortran-80.

Software Systems Commercial Basic (CBasic) is sold for £76 by Xitan in Southampton or \$95 from the U.S. It is a disc-extended Basic compiler which works to 14 digits in binary-coded decimal format, thus providing very high accuracy. It will operate in an CP/M system of 20K or more.

From Micropro there are three packages to sort, merge or extract fixed- or variable-length records written in binary, BCD, packed decimal, ASCII or EBCDIC. They are sold as Super Sort 1, 2 and 3 at \$250, \$200 and \$150 respectively.

Micropro also has the Word Master text editor for \$150. It works in either of two modes. The first uses a super set of the CP/M ED commands, allowing global searching and replacement either forwards or backwards in file. The second is video mode and provides a full screen editor for users with a serial addressable-cursor VDU.

CORRESPONDER is a mailing list system which can generate letters and can sort and extract customers by names or addresses. It costs \$95 and requires Software Systems CBASIC.

ISAM is a useful-sounding system with triple-level index filing which meets the full ANSI level II Cobol capability; it costs \$145.

The American software house, Structured Systems Group, offers four programs — General Ledger for \$995, Accounts receivable for \$750, NAD (a name and address selection system) for \$79, and QSORT (fast sort/merge) at \$95. All four require CBasic.

WHATSIT is a very interesting interactive base data system which retrieves information by subject. It requires CBasic and costs \$125. The Byte Shop offers a base data enquiry system also called WHATSIT; it works on a standard Horizon computer with North Star DOS and costs £45.

SOURCE is an 8080 or Z-80 disassembler which converts a binary disc file into mnemonics which may be used with MAC or their Xitan ASM assembler. It costs \$70.

ZASM is a disc-based assembler for mnemonic Z-80 which creates output in absolute hex addresses and costs £45.

Several business programs are available from The Byte Shop. Among them are INVENTORY-1, a stock control program for retailers; up to 1,000 lines may be stored. The package keeps track of items running low, slow-moving items, profitable lines. It costs £85.

# Solving printing problem for Cromemco users

ALL COMPUTER USERS at some time will want a printout capability. For those with a Cromemco Z2-D but not fortunate enough to have a parallel printer, printouts will prove something of a problem.

There are now many relatively cheap serial printers on the market. They can be used with the Z2-D by making a few minor changes to CDOS, leaving all its intrinsic commands unaltered; more important, this can be done without hardware changes.

To add any type of printer to an existing Z2-D system with, say, a disc driver board, 32KB of memory and a processor board, an I/O port, will have to be added. This can be done easily by adding a TUART board to the system. The Cromemco board has two universal asynchronous receiver transmitters, hence the acronym.

by Andy Mead

Each UART has a serial and parallel I/O port. CDOS uses one of the UARTs set at a base address of 50 hex to communicate via the parallel port to a parallel printer. By modifying CDOS, the serial port of that UART can be used to provide printouts. The remaining UART on the TUART board can be set to some convenient base address, which does not clash with any of the I/O ports present in the system. I assumed a value of 60 hex,

Figure 1. Original CDOS jump table

```

0000" C3EE71#    0021 WBOOT: JP    SYBAT ;WARM START
0003" C3517C"    0022 CSTAT: JP    COSTAT ;CONSOLE STATUS
0006" C3597C"    0023 CIN: JP     CONCIN ;CONSOLE INPUT
0009" C36E7C"    0024 COUT: JP    CONOUT ;CONSOLE OUTPUT
000C" C3A17C"    0025 LGUT: JP    PLPOUT ;PARALLEL LINE PRINTER DRIVER
000F" C3C17C"    0026 POUT: JP    PUNOUT ;PUNCH OUTPUT
0012" C3CC7C"    0027 RIN: JP     PUNIN ;TAPE READER INPUT
0028 ;
0029 ; DISK HANDLERS FOLLOW
0030 ;
0035 ;
0027" C3EE71#    0036 RBOOT: JP    SYWDAT ;REEBOOT
002A" C3B97C"    0037 LSTAT: JP   PLPSTAT ;PARALLEL PRINTER STATUS
002D" C38B7C"    0038 CSET: JP    CONSET ;CONSOLE X,Y ADDRESS SET
0039 ;
0040 ; END OF JUMP TABLE
0041 ;

```

This article shows how users of a Cromemco Z2-D system can use a serial instead of a parallel printer for printouts of programs and results. The hardware required is the same. The only changes are to the software printer driver in the Cromemco Disc Operation System (CDOS). All the intrinsic commands of CDOS and those of other Cromemco software packages remain unaltered.

since this is an easy value to remember.

Two features of the TUART board must be taken into account by any changes made to CDOS when incorporating a serial printer into the Z2-D system:

- serial baud rate selection by software;
- base address-swapping between UARTS by software.

The second facility can be disabled by one of the switches on the TUART board. If the swap facility is not disabled, the addresses of the two UARTs can be reversed when the system is turned-on. That can give the unwary many headaches if not spotted quickly!

When any computer communicates with its user, it does so via a driver routine. CDOS is no exception. To add a serial line printer, the parallel printer driver routine in CDOS should be replaced by a serial routine.

## Swap facility

The baud rate and the swap facility of the TUART must be included in the

changes to CDOS. Since we only need to execute those once, they can be included in the initialising routine of CDOS.

Baud rate	Open-stop bit	Two-stop bit
100	81	01
150	82	02
300	84	04
1,200	88	08
2,400	90	10
4,800	A0	20
9,600	C0	40

Figure 2. The baud rate byte for TUART.

CDOS uses a jump table to find the routines it needs to communicate with the outside world. A jump table is a list of jump instructions which tells the computer where to find a particular routine. The original jump table used by CDOS is shown in figure 1. Following the jump table is the CDOS initialising routine INIT, which sets up all the I/O ports used by the Z2-D.

We then have all the information necessary to make the changes to CDOS. The first thing to be done is to set the addressing mode of the TUART to the normal state, followed by the baud rate of the serial port. Those additions can be done using the DEBUG program with most Cromemco software packages.

## Additions

Normal addressing mode is selected by outputting 0hex to the parallel port with base address 60 hex. The baud rate of the serial port is selected by outputting one of the bytes corresponding to the baud rate,

```

0001 ;
0002 ; MODIFIED CDOS INITIALISATION ROUTINE
0003 ; ADDRESSING SHOWN FOR DEBUG
0004 ;
13B3 F3 0025 INNEW1: DI ;DISABLE INTERRUPTS
13B4 3E0B 0026 LD A,00 ;SET UART NORMAL ADDRESS MODE
13B6 D364 0027 OUT 64H,A
13B8 3E01 0028 INCLD: LD A,01 ;ORIGINAL CDOS INIT ROUTINE
13BA D340 0029 OUT 40H,A
13BC AF 0030 XOR A,A
13BD D303 0031 OUT 03,A
13BF 3E52 0032 LD C,52H
13C1 3E09 0033 LD A,09
13C3 ED79 0034 OUT (C),A
13C5 D322 0035 OUT 22H,A
13C7 0C 0036 INC C
13C8 97 0037 SUB A,A
13C9 ED79 0038 OUT (C),A
13CB D323 0039 OUT 23H,A
13CD 3E0F 0040 LD A,0FH
13CF 81 0041 ADD A,C
13D0 4F 0042 LD C,A
13D1 30EE 0043 JR NC,13C1H ;END OF INIT ROUTINE
0044 ;
0045 ; REMAINING MODIFICATION
13D3 3E38 0046 INNEW2: LD A,88H ;BAUD RATE OF SERIAL PORT
13D5 D350 0047 OUT 58H,A ;OUTPUT TO PORT 50HEX
13D7 C9 0048 RET
0049 ;
13D8 (13B3) 0049 END
    
```

Figure 3. Modifications to the CDOS initialisation routine.

```

0000* C3EE71# 0021 WBOOT: JP SYBAT ;WARM START
0003* C3717C" 0022 CSTAT: JP CSTAT ;CONSOLE STATUS
0006* C3797C" 0023 CIN: JP CONCIN ;CONSOLE INPUT
0009* C38E7C" 0024 COUT: JP CONOUT ;CONSOLE OUTPUT
000C* C3587C" 0025 LOUT: JP SLPOUT ;SERIAL LINE PRINTER DRIVER
000F* C3C17C" 0026 POUT: JP PUNOUT ;PUNCH OUTPUT
0012* C3CC7C" 0027 RIN: JP PUNIN ;TAPE READER INPUT
0028 ;
0029 ; DISK HANDLERS FOLLOW
0030 ;
0035 ;
0027* C3EE71# 0036 RBOOT: JP SYWDAT ;REBOOT
002A* C3577C" 0037 LSTAT: JP SLPRET ;SERIAL PRINTER RETURN
002D* C3AB7C" 0038 CSET: JP CONSET ;CONSOLE X,Y ADDRESS SET
0039 ;
0049 ; END OF JUMP TABLE
0041 ;
    
```

Figure 4. New CDOS jump table

shown in figure 2, to the serial port with base address 0. Those additions to the initialising routine, together with that routine, are shown in figure 3.

When making the additions to CDOS, all the routines below INIT should be moved down over the parallel driver routine, leaving INIT and the routines below the paper punch output routine unaltered. That, of course, means that some of the entries to the jump table will be altered. The new entries are shown in figure 4.

The serial output routine (figure 5) starts by SAYing the accumulator, which contains the character to be printed, on the stacks. That protects the character from the following loop, which tests the status port of the UART to see if a character may be printed. When the program branches-out of the loop, the printable

character is transferred back from the stack to the accumulator, and then output to the printer via the output serial port.

The printed character undergoes a further test after it has been printed, to check whether it was a line feed. If not, the printing routine makes a return; if a line feed has been issued, the printer routine enters a simple count-down delay loop. A null is printed on the console device for every pass round the loop.

That loop allows a mechanical printer the time to perform a carriage return and line feed. The timing of the loop can be tailored to the particular printer used. For figure 5, the printer used is the Axiom EX-800; the delay gives a comfortable printout rate of 1,200 baud. The long delay is needed because the printer does not output any characters until it receives a carriage return/line feed pair. For faster printers the delay can be reduced or even omitted.

**It works**

The new jump table contains the entry points for the new line printer driver, as would be expected. Since the old table had a line printer status called, the new one has to retain that call. The status was asked for by the old CDOS routine to check the position of the parallel printer during its printing operation; as that is taken care of by the new line printer driver, the entry in the jump table is a reference to a RETURN instruction.

Does the altered CDOS work? The answer is yes, once the modified version of CDOS has been transferred by a WRSTSYS operation to the boot blocks of the disc. This article is confirmation that it works; it was written using Cromemco word processing software and printed-out using a serial printer. □

Figure 5. Serial line printer driver routine.

```

0001 ;
0002 ; CDOS SERIAL LINE PRINTER ROUTINE
0003 ; ADDRESSING SHOWN FOR DEBUG
0004 ;
13D8* F5 0005 PUSH AF ;SAVE CHARACTER & FLAGS
13D9* D850 0006 OUTP: IN A,50H ;GET OUTPUT STATUS
13DB* E680 0007 AND 80H ;READY TO PRINT?
13DD* 28FA 0008 JR Z,OUTP ;WAIT FOR OUTPUT
13DF* F1 0009 POP AF ;RESTORE CHARACTER TO A
13E0* D351 0010 OUT 51H,A ;PRINT IT
13E2* FE3A 0011 CP A,0AH ;LINE FEED?
13E4* C0 0012 RET NZ ;RETURN IF NOT
13E5* C5 0013 PUSH BC ;SAVE B & C
13E6* 0628 0014 LD B,28H ;DELAY COUNT
13E8* 3E00 0015 DELAY: LD A,0 ;ASCII NULL CHARACTER
13EA* CD697C 0016 CALL 7C89H ;PRINT CONTENTS OF A
13ED* 10F9 0017 DJNZ DELAY ;LOOP UNTIL B=0
13EF* C1 0018 POP BC ;RESTORE B & C
13F0* C9 0019 RET ;FINISH PRINTING
0020 ;
13F1* (13D8) 0024 END
    
```

# Lessons in teaching computers to learn

ARTIFICIAL INTELLIGENCE is a wide-ranging subject, involving problem solving, game playing, pattern recognition, theorem proving, automatic program writing, semantic information processing, robotics and learning. All are attempts, some successful, some not so successful, to mechanise human thought processes. Of these, the last, learning, is still clouded in too much mystery.

It has been long known that animals and people understand and do things better with experience and that the improvement is related directly to the amount and type of the experience they gain. It seems strange, therefore, that so little attempt is being made to apply the same ideas to computerising, that man-made source of excessive information processing power.

In fact, research goes on all the time and many techniques for computer learning are known, even though the programmer is faced with another level of abstraction above the problem the computer is set.

## Great potential

A few examples of learning algorithms are presented, more to show how and what because the "why" is easy, it shows great potential for improved data processing and it stimulates the grey matter. Given the state of the art, a discussion of the social implications of computer learning would be premature but for those interested in very low-grade prediction, science fiction has volumes to say on the subject.

Rote learning is a technique in which some information is stored in a memory, computer or brain, and then recalled verbatim later. Most schools teach multiplication tables in this way. A poem must be learned by heart and repeated word for word. The storing of a byte in random access memory of a computer can be described as rote learning. Data files fall into the same category; one section of code will store some information in a prescribed place and another will recall it.

A practical example of the technique is the 'teach' mode in an industrial robot. A manipulator is required to carry-out repeatedly a sequence of actions with extreme regularity and monotonous accuracy. Before it can do so, it must be told what actions to perform.

One could instruct it by writing a program in machine code, Fortran or one of the languages developed specially for numerically-controlled machines but this is a remarkably time-consuming chore.

More often a skilled worker 'leads' the machine once through the task, using a joystick or hand control to 'teach' it the key positions to which it must go and the actions it must perform.

With this set of co-ordinates in the memory of the controlling computers, the robot will cycle through the sequence in a mindless way, sometimes not stopping if the work fails to be fed to it properly.

Adaption or parameter learning represents the next step up in the ladder. In this case, the overall structure of the problem has been solved already and only the final details remain to be worked-out. One major success of adaptive learning

time. After a number of attempts, the parameters are well tuned and it almost always recognises the pattern.

Rosenblatt's Perceptron is one of the better-known mechanisms of this type. It dates from the early '60s and was intended to model the idea of a neural-net brain mechanism, with neurones and synapses, inhibitory and excitatory connections and synapse facilitation.

Figure 2 shows a pictorial representation of the structure of a perceptron to classify visual stimuli. In theory, it could be used to predict the weather or any other situation where there are examples giving a well-defined state.

**Mark Witowski, a researcher in Artificial Intelligence, looks at Perceptrons and the problems of making machines learn.**

machines has been in pattern recognisers and classifiers. The program will be expected to name a pattern when shown, such as a handwritten letter of the alphabet (figure 1), out of a whole class of possible patterns, such as all the letters of the alphabet.

One trains it by showing the machine several samples of each letter. If it misrecognises the letter, a part of the algorithm is called which adjusts internal parameters so that it will do better next

Figure 1. Some examples of handwritten 'A's and some NOT('A')s.



Connected to the retina — typically 20 by 20 points — would be a number of association-units (A-Units). Each A-Unit would be linked to a small number of retinal points by some excitatory links which would add something to the A-Units if that point was stimulated and some inhibitory links.

## Weighting factor

For any given pattern, each A-Unit would either output a 1 if more excitatory points were activated than inhibitory, otherwise zero. Each of these outputs is then multiplied by a weighting factor and all the results are fed into a summation unit which, as its name suggests, adds all the values.

If the result is negative the pattern did not belong to the target class; if positive, it did. There will be one set of weights and summation unit for each pattern class. If the operator disagreed with the machine's classification, the values of the weights which contributed to the incorrect classification would have to be modified. This 'training' algorithm is very simple.

The perceptron is surprisingly effective with position invariant data and is very tolerant of noise in the image. It will discriminate a hand-written capital letter from the set A, B, C, D, E, F, G and H with about 95 percent accuracy, after being trained with 10 examples of each.

Interesting as the perceptron is, both as a trainable adaptive learning machine and as a brain model, its popularity waned considerably after a series of essays in the late '60s on computation by Minsky and Papert, of the Massachusetts Institute of Technology, in which it received some heavy, if somewhat unjustified criticism.



The theory and practice of the technique, however, are still valid; non-parametric training machines and their descendants live on. They are found not so much in visual pattern recognition but in speech recognisers. Because each speaker's voice is sufficiently different from every other's that it is almost impossible to analyse the waveforms, each speaker is asked to say each of the words in the vocabulary to be used several times before using the machine. This turns out to be a quick, convenient and satisfactory idea, giving good recognition rates in almost all cases, with minimal extra programmer effort.

Interest next passed to more formalised programs in which descriptions are

matched and the differences used to generate more accurate descriptions. Patrick Winston of MIT made his name with a 'concept' learning program. He input to his program descriptions of simple structures made from blocks.

After being shown a number of examples, some of which are the structure and some of which are 'near-misses', the program would augment its internal description of the scene with notes to tell it whether something must or must not be present, to allow any input description to be a member of the class. Figure 3 shows a very simple example.

The program is being taught what a 'tower' is — a cylinder with a cone on top. The teacher shows it one example and

then a near miss. Each generates an internal description, which shows each object and its relationship to all the others — above, below, supported-by.

Every time a new example, or a near miss, is presented to the program a set of differences between the old description and the new is produced. If it is a new example, one of nine possible actions stored in a table is applicable, two of which represent contradictions with previous examples.

A near-miss case means that the description must be updated with one of 10 possible actions, depending on the nature of the observed difference, usually by adding a 'MUST-BE' or 'MUST-NOT-BE' node to the model. Figure 4 shows the description after a few more attempts.

While this program demonstrates a point about learning concepts, it has its weaknesses — and other strengths to which this all-too-brief description fails to do justice; it still requires a trainer or teacher. If it is to work well the algorithm should be shown an example first and near misses should have only a single difference from the hit. Paradoxically, it's strongest failing is in the excessive power of its descriptive ability.

Winston could argue that this has to be the case for effective learning. But this holds true only if the pupil and teacher are interested only in towers and houses and arches and other constructions of toy blocks.

## Descriptions

As soon as discussion moves to all primitive descriptions, such as 'MUST-BE-SUPPORTED-BY', 'MUST-NOT-TOUCH', the previous descriptions would be inappropriate and of very little use. We can then argue that a learning program must either have a large number of powerful descriptive tools at its disposal, or we search for some weaker but more generally-applicable descriptions about the world. They will then be combined to form the wide range of descriptions needed.

In all learning systems discussed so far a human provided the motivation and the correct examples the program required and generally guided things along. Young children learn, partly by being taught, but also by observing the world as it passes

*(continued on next page)*

Figure 2. Basic Perceptron mechanism.

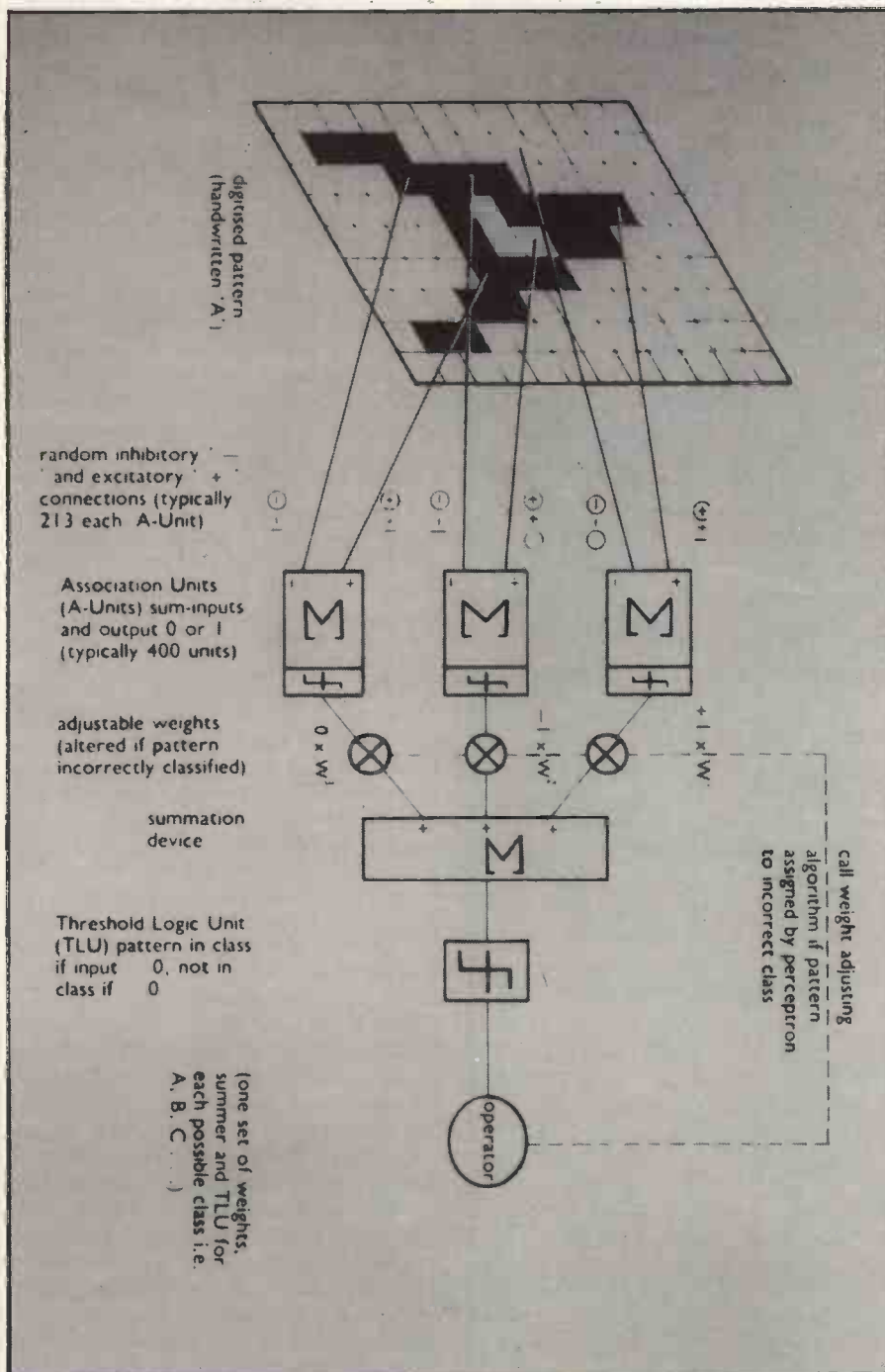

(continued from previous page)

them by, and more so by playing with it, pulling an object apart, dropping it, and by general experimentation and investigation.

Learning by discovery; such power; a program with curiosity; what a curiosity. No longer can a learning algorithm stay in isolation. Now the computer must be able to perceive its environment.

It must be able to move around and discover the effects of doing. It must behave as well as sense and learn; it can no longer be a passive heap of electronics upon which information is deposited and from which ASCII flows.

Laboratory robots provide the right

kind of peripheral for this task. Laboratory robots differ from their industrial counterparts in several ways. They are usually smaller and physically less powerful, but with more sophisticated computers to control them. They must also carry a great many sensors; they will provide the information, the learning, or any other control algorithm will use to make deductions and correct its actions in the world.

Learning programs show enormous potential in the field of robot control. The less you can rely on mechanical accuracy the more the emphasis shifts to using sensory information. A robot's view of the world is egocentric about its own sensory data, which for a typical robot, if

there is such a thing, is different from our own.

### Theorem prover

A number of robot projects involve all the essential human ingredients. One is SHAKEY, the product of a Stanford Research Institute team. Its 'intellect' was provided by a predicate calculus theorem prover called STRIPS, in which information about the world in which the robot must operate is stored as 'well-formed formulas' (wffs).

For instance, CONNECTSROOMS (D1, R1, R2) tells the system that door 1 connects room 1 with room 2. Robot action routines, such as GOTHRU (D1, R1, R2) would cause the robot to go from room 1 to room 2. The power of these constructs is not from the ability to execute them directly as commands but by being able to plan routes and complex actions using them.

Each action, like GOTHRU, has associated with it a list of things which would change if it were to be executed, and a list of things which must be true before it can be attempted — the pre-conditions wff.

The add and delete functions update the model of the environment as though the action had been carried-out. Thus INROOM (ROBOT, R1) is the pre-condition and will be deleted by GOTHRU(D1, R1, R2); INROOM (ROBOT, R2) would then be added.

### Tasks for robot

Every significant object in the robot world and every action it can make are described in this way. Tasks SHAKEY must perform are also described as wffs, for instance:

Goal: ( x ) [BOX(x) INROOM(x, R1)]

asks SHAKEY to produce a plan for moving box x from where it is into room 1. To do it the robot may have to go through some doors to where the box is, push it through some more doors until it is in room 1. STRIPS builds a plan from the basic operator actions, which is then passed to PLANEX (plan executor system) on a PDP15 system, which will then control the robot directly through the planned sequence of actions in real time.

The main force behind STRIPS and SHAKEY was not in learning but rather in the predicate calculus problem-solving. Sensory information from tactile 'whiskers', a range finder and television camera was used mainly to check that the information in the database was correct, rather than to add new data to it.

Learning, however, is achieved in two ways. First, a triangular table can be constructed of all the steps in a plan. The table is triangular because the add-list becomes longer as more actions are taken. This table shows all the pre-conditions, add-lists and operators at each step. The stored plan can be used at a later stage as a fully-computed sub-plan, saving the resol-

Figure 3. A hypothetical example of Winston's 'concept learner'.

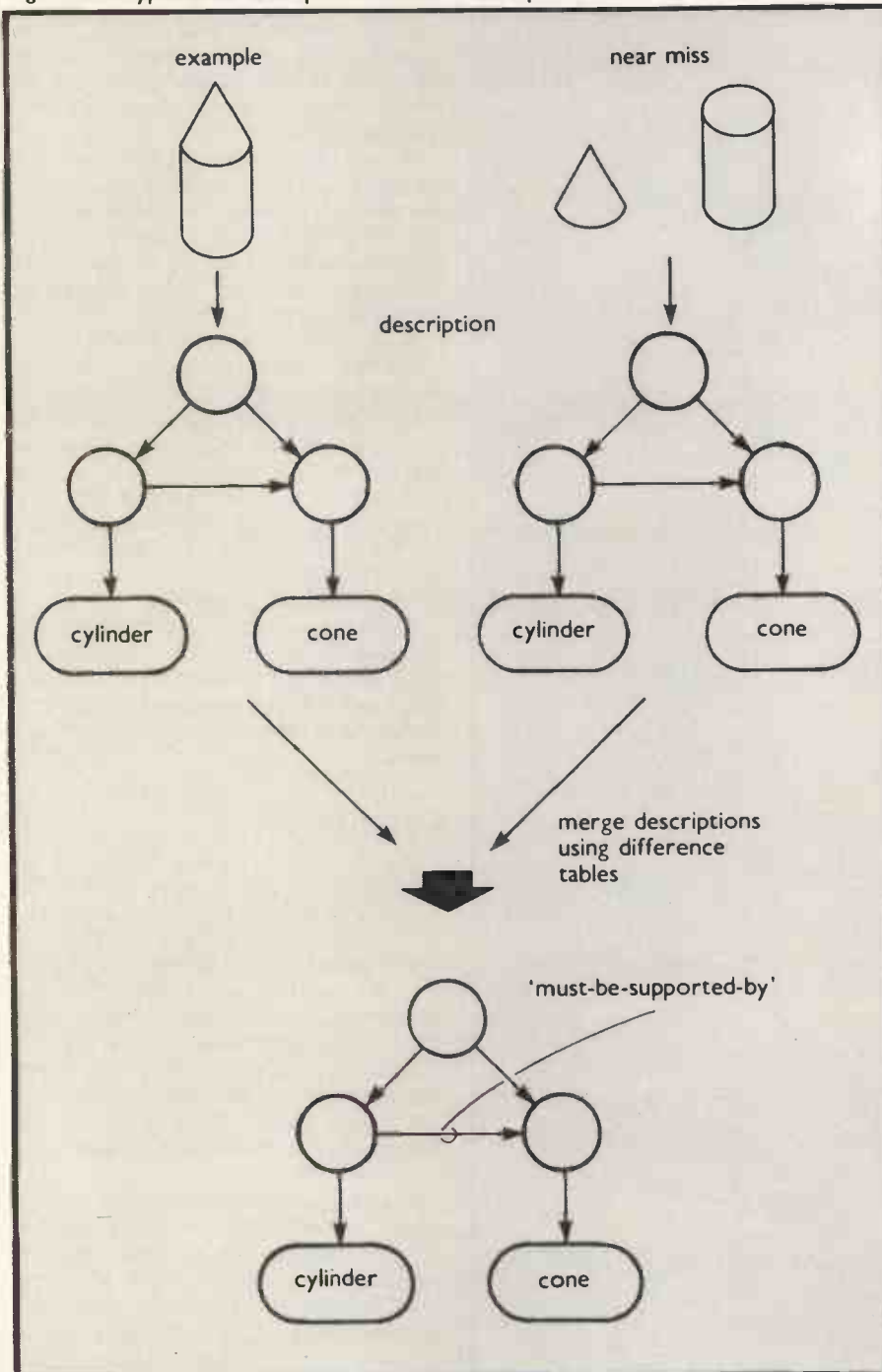



ution algorithm a vast amount of computing.

The second form of learning is one of generalisation. It would replace specific instances of room, box and door by variable names; therefore one plan would fit a number of situations.

All these forms of learning are inadequate, since in them learning must progress by the program and robot doing something, making some action and then observing the effects. It ought still be able to learn passively, by observation, and by imitating a teacher performing the same actions; any final algorithm we devise should take into account all of these forms.

We should be able to command it to do things, only having to specify what should be achieved in the goal state, rather than having to give an explicit instruction sequence. The algorithm would then use a combination of a plan-forming mechanism to work out how to do it, perhaps like STRIPS; and a mechanism which always adds anything new or unexpected into its database memory.

## Penalty

It is not necessary that the robot be engaged actively in any specific goal or task for the learning process to continue. At other times it might make movements and actions to test what happens, rather like a toddler. It might use a previous goal as a model, perhaps one which needed a long time to complete, or one of its sub-goals which proved to be inadequate, which was generated during the planning process.

It might have a list of 'things to try' input by the user. It might take a particular sensor and see how its output changes in relation to actions made and the outputs of all the other sensors. Making even random actions is far better than doing nothing. These processes are equivalent to play and curiosity, well-known when applied to people and animals.

All this adds-up to a robot control program which performs better the next time. As a penalty for these potential gains one must dedicate a substantial amount of computing and engineering facility, since learning programs can be expected to learn, as do people, painfully and slowly. It is very difficult, however, to program robots to do anything interesting and this penalty will probably be worth paying.

Although human intervention is not ruled out in learning algorithms, with the other algorithms — adaptive and concept learning — the user was an essential part of the process. Even with the most general algorithms available somebody, somewhere is still required to specify useful goals.

If this type of algorithm becomes widespread, computers will be 'taught' and 'guided' rather than programmed. With our state of knowledge it would seem as if

it will be a long time before we can expect the acquisition of natural language through learning, which would open the doors to a wide range of interesting possibilities.

ALP is a learning program developed at London University by David Mott which incorporates a significant number of the ideas discussed, albeit at a fairly primitive level. ALP uses a laboratory robot connected to a mainframe in which the learning program resides.

Instead of SHAKEY's world with rooms, doors and boxes, it lives in a simpler world dominated by a light and battery charger. Its task is to 'survive' by not letting its batteries run down.

The formal logic of STRIPS is not suitable in such a situation. Instead, information is stored in SCHEMA, which have a form better-suited to the uncertainty a naive robot has about its environment. Schema are built as information flows from the sensors into Short Term Memory — STM — a term borrowed from psychology — and are stored in Long Term Memory (LTM).

Each time the contents of the continually-updated STM change it uses, its model of the environment stored in LTM predicts what will happen. Schemas are built up from KERNELS — the elemental sensory and motor information which can be received into STM. A schema is set up

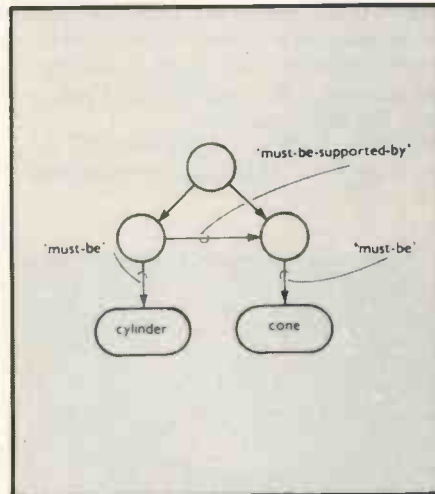

Figure 4. The final description of 'tower' after more 'examples' and 'near misses'.

so that the kernels on its left-hand side predict some kernel on the right-hand side. There are only two kernels known to initially to the system, LOW and HIGH, which the user may include in schema to mean situations which must be avoided and those which should be achieved.

If the contents cause a LOW to be predicted, ALP will use its knowledge in LTM to plan a course of action to avoid this fate; a HIGH would encourage achievement. The progress of the plan is monitored continually because the program has only uncertain information about the effects its actions will produce. If it fails completely to avoid LOW, it must call for help. The environment can

then be 'shaped' by placing the robot in a position where it cannot help but discover the answer.

Starting with little or no information about the environment the program attempts to build schema in LTM so that it can always predict what will happen. At a certain level of proficiency the environment might be changed to see how quickly it coped with the alterations.

The prediction mechanism drives the learning part of the program. If STM has predicted correctly, all is well and good. If no prediction is made, a new schema may be formed from the current and previous contents of STM. This happens more often when LTM is still relatively empty.

If an incorrect prediction was made, the schema which caused it may be modified, either by removing a kernel which was obviously redundant and happened to be in STM when the schema was formed, or by adding a new kernel if it was missing at first.

## More diverse

The algorithm is non-trivial and schema modification is based on numeric information stored with the schema. ALP has learned to find a battery charger using the light when the robot's batteries began to fail, so that it could re-charge itself. The relevant contents of LTM can be converted automatically into code for a low-level minicomputer which will execute the learned code in real time.

There is always a trade-off between the labour of putting specific information into the database by hand and waiting while the computer laboriously finds out things for itself. Which means, in real terms, that the learning computer is not the all-embracing advantage some have promised. Progress is being made in this field, however, and the ability to learn will make computers useful in even more diverse applications.

Some further information about these projects, which, when you realise they all needed several years' work, often by a team of people, can be found in: Winston's book *Artificial Intelligence* (Addison Wesley) and *The Thinking Computer* by Raphael Freeman. Experimentally-minded readers may be interested to know that LISP, the high-level AI language, which is used for the examples in Winston's book is available for the M6800. 

# Rewards to be obtained from lucid approach

READING the newspapers aimed at professional programmers, one cannot help noticing the phrases 'top down design', 'modular programming' and 'structured programming'. These modern programming methods are being used in commercial installations because their implementation leads to substantial savings in the time needed to develop easily maintainable software.

Initially, computing machinery was so excessively expensive that a saving of one second of execution time or 1/4K of core memory could have been worth a considerable amount of a programmer's time. In consequence, programs were judged as much on their ability to use the hardware efficiently as to produce correct results.

Today's computer managers, with cheaper, faster hardware and mounting salary bills, have inherited a collection of incomprehensible and inflexible programs which are awkward to use and very difficult to maintain. It is not surprising that there has been a shift in emphasis to the production of software which is easy to understand and maintain which can be thoroughly tested and proven.

The small user can benefit from the experience of the professionals in this area. The reduction of development time is not unwelcome, neither is the minimising of maintainance — for instance,

when patching old programs to a newly-enhanced system or adapting someone else's program. Since big systems tend to use customised software while the small user often relies on mass-produced packages, the availability of highly-adaptable, easily-understood programs is even more desirable.

In this article I discuss the concepts underlying modern programming techniques. In my next article I will show how the methods can be used to write a games program in both Basic and Pascal. The method is not dependent on a particular language, although implementation is

data carefully. The design process should be completed before any coding — writing the program — is stored. Designing, whether before or during coding, has a trial-and-error element in it. After completing one part, it may become clear that some previous section should be discarded.

The greater the amount of time already spent on that section, the greater the temptation to patch the program instead. If one designs before one codes there is not the same investment in time — when compared to typed-in code — and so mistakes are psychologically easier to

**Susan Eisenbach, of the Polytechnic of the South Bank, explains the use and disciplines of structured programming.**

easier and more natural in a language designed by one of its adherents.

Given a problem to solve with a computer program, the first step is to define the problem clearly. That may sound obvious but it is not uncommon to think 'I'll do something about X' and then expand the problem as one proceeds, at best, finishing only when it becomes uninteresting — the result being, at best, a rather ungainly program.

Once the problem is defined clearly, the next stage is to design the program and

correct. Once the design has been completed it is a more straightforward task to code.

During the design stage of program development, attention is focused on the structure of both the program and the data. Which one is more important depends on the problem.

## Data structures

To design the necessary data structures, one has to consider all the data which is the subject of the program being planned. What are the ways available for representing that data within the program? For example, if your problem is a card game, how should you represent the cards? Three possible alternatives are:

- A  $13 \times 4$  array where the row number gives the value of the card and the column number its suit.
- A  $52 \times 2$  array where the first dimension contains the value and the second the suit.
- A  $51 \times 1$  array where the code of each card is an element in the array.

Should the cards be represented by characters or integers? Time spent at that stage of design, choosing the data structures which best suit the problem, will simplify the rest of the design and coding.

After the data structures have been designed, the next stage is the designing of the program structure. That is sometimes called 'stepwise refinement', because it involves identifying the major problems to be solved and from there expanding the problem progressively into more and more detail, until reaching a low enough level to begin coding.

At the top level, a single block or 'module' — see the hierarchy diagram in figure 1 — solves the entire problem. At

Figure 1. A hierarch diagram.

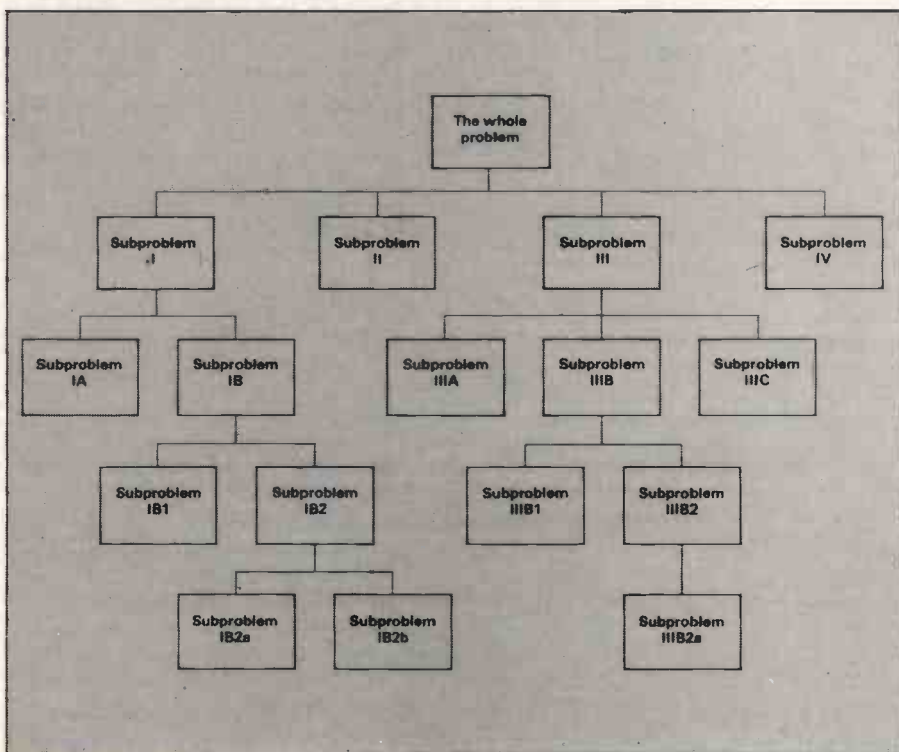



the second level, that is subdivided into several subproblems (modules), which in turn are subdivided, and so on.

How does one subdivide a problem in this way? Each module should accomplish a single function. In a card game there could be a module which deals the cards. It could be broken-down into two modules — one which shuffles the cards and a second which distributes them. The fact that it might be difficult to program the function should not cause any worry at that stage. Instead, attention should be paid to defining the module completely. That consists of a specification of input and output parameters and a description of the function to produce the output parameters from the input parameters.

Eventually one will reach a point where the modules can no longer be broken-down into simpler amounts. It is then time to start programming. The top module is the main program, while all other modules are coded in subroutines or procedures. The first line of each module should contain a clear description of its function — e.g. in Basic 100 REM SUBROUTINE TO SHUFFLE CARDS, in Pascal PROCEDURE CARD SHUFFLER. The last line of each module is its only exit. Having exactly one entry and one exit point for each module, reduces program complexity and makes it easier to trace program flow.

## Use of stubs

Top down coding — of the program in figure 1 — begins by writing the code for the main module as if the second level modules already exist. The code includes subroutine calls to those modules. Next dummy modules, called 'stubs', are written for modules I, II, III and IV. They consist of a first line with the function description, the return to the calling program and a few lines of code which will allow the main module to be tested. That might accept, from a terminal, the values of the output the data module will compute later.

The use of stubs enables the checking of program logic and interface. When the first module is working properly, the next stage is to replace a stub with code. The code written for this level-two module will contain, if needed, subroutine calls to level-three modules, and stubs for those modules must also be written.

Each time another module is written, it should be tested completely. Data should be input which requires every branch to be traversed. Since the new module will be integrated within the rest of the program, it can be seen that it functions correctly as part of the whole program. The process of replacing, and testing, stubs with code continues until the whole program is coded.

There are many advantages of this 'top down programming and testing'. Firstly, only a small section of code is being tested at any time, so it is easy to pinpoint any

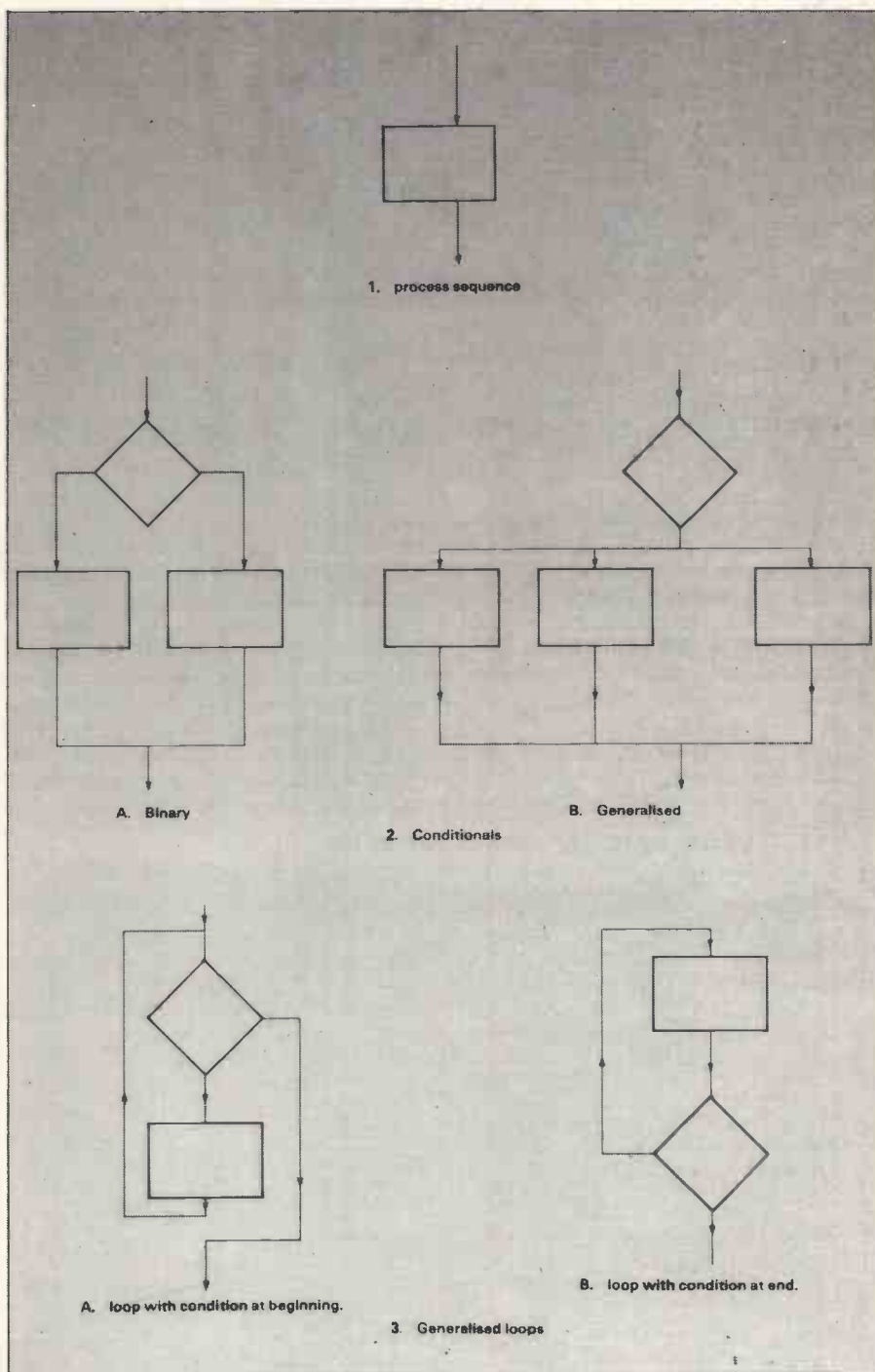

Figure 2. Control structures.

difficulties. Secondly, major errors in program logic are detected before minor ones, because modules are tested in order of importance.

Thirdly, testing is spread throughout the program development, so one is not left with the daunting task of testing a large program, which tends to be tested until it appears to work, rather than until all paths have been traversed. Lastly, the continuous integration of new modules as they are written eliminates interfacing problems between sections of code.

The same type of care and attention used to design the structure of a program is also focused on the coding. Regardless of the language when writing a program,

the same component building blocks are used. They are sequential statements — e.g., Basic LET X = Y \* Z, Pascal X := Y \* Z; unconditional branches — e.g., BASIC GOTO 10, Pascal GOTO LABEL; and conditional branches — e.g., Basic IF X = Y THEN 100; Pascal IF X > 0 THEN Y := Z/X ELSE Y := 0.

Because programs are particularly helpful for solving repetitive tasks, almost all languages provide a loop construct as well — Basic FOR I = 1 TO N ... NEXT I, Pascal FOR I := 1 TO N DO ..., WHILE ... DO ..., REPEAT ... UNTIL ... — even though this is not

(continued on next page)

# Structured programming

(continued from previous page)

strictly necessary, since looping can always be achieved with branching. If a language has the correct type of loop and conditional branch constructs, unconditional branching becomes unnecessary.

Structured programming is a technique which lays down rules about which of those constructs should be used in a program to make it simpler, more readable and easier to change. It can be shown that any algorithm, excluding recursion, can be broken into steps using three basic building blocks — sequence, conditionals and loops. They are the only constructs allowed in a structured program.

## Variations

Figure 2 shows, in flowchart form, the three control structures, with their variations. A process sequence is one or more program statements, or any other proper computational sequence with one entry and one exit, such as a subroutine or procedure, which move forward the program control.

A binary conditional — IF . . . THEN . . . ELSE . . . — causes execution of one of two choices depending on whether a statement tested is true or false. After the

THEN or ELSE branch has been completed, program control moves to the same instruction. The generalised conditional is a logical extension of the binary conditional, in which control switches to one of several alternatives, depending on the value of a test variable. Again, after execution of the appropriate process, control moves to the same instruction.

## Loop test

Although all loops can be implemented by a loop controlled by a test at its beginning, there is no need to be so restrictive. Having three loop control structures makes programs easier to read and write. Indefinite loops, those executed until some condition is satisfied — or not satisfied — can have their test either at the beginning or the end of the process. Definite loops, those controlled by a counter, are also allowed.

Structured programming is sometimes called 'GOTOless programming' as it avoids the use of branches except in certain well-defined cases. The liberal use of GOTOs tends to result in the logic of many programs being difficult to follow. Altering a program which contains indiscriminate branching can lead to

unexpected and unwanted results. Some programming languages, such as Pascal, designed within a structured programming framework, have the constructs necessary for its straightforward implementation. In those languages there is no need to use GOTO statements.

In other languages such as Basic, lacking some of the structured constructs, the implementation of the control structures requires a limited use of GOTO statements. REMarks should be used to highlight the control structures. Unfortunately, using structured constructs in a language which does not have them implicitly leads to an awkward programming style. Figure 3 shows possible implementations of the structured constructs in Basic and Pascal.

It should be noted that whatever the language, program flow always moves forward from basic building block to basic building block. Even within the blocks there is only one backwards jump which occurs at the end of a loop. The lack of complexity inherent in a structured program makes it easy to understand and maintain.

## Rewards

If a program is to have a long life, to be alterable when conditions make changes necessary, it is most helpful for it to be well-documented. Standardisation is one of the essentials of good documentation, because it makes the program easier to follow.

Good structured programs — well-commented if the language does not contain the structured constructs — are nearly self-documenting. Flowcharts, useful for the unstructured program where it is difficult to follow the program logic, do not add any additional information to the structured program. What is useful is a description of each module — subroutine, procedure — and the relationship between modules.

The description of each module should include a list of input parameters, a list of output parameters and a description of the process performed. A hierarchy diagram such as in figure 1 shows clearly the calling relationships between modules.

It is a tenet of modern programming that documentation should be produced during the design stage. A claim that documentation before coding is a waste of time, as it will need changing, is an admission that designing was not completed before coding started.

People who have programmed without these methods often find them awkward and restricting at first. Perseverance, however, brings, with an increasing ease, the rewards of lucid programs and the satisfaction that the job has been well and professionally done. My next article, which will take a game similar to Mastermind from design stage to final coding, should make the ideas detailed here appear more concrete.

Figure 3. Implementation of control structures.

Control Structure	Implementation in Basic	Implementation in Pascal
1. Binary Decision	<pre> 10 IF CONDITION THEN 30 20 GOTO 70 30 REM THEN  : 60 GOTO 100 70 REM ELSE 100 REM ENDIF                     </pre>	<pre> IF CONDITION THEN ... ELSE ...                     </pre>
2. Generalized Decision	<pre> 10 REM CASE STATEMENT 20 ON INDEX GOTO 30, 60, 90 30 REM CASE 1  : 50 GOTO 110 60 REM CASE 2  : 80 GOTO 110 90 REM CASE 3  : 110 REM END CASES                     </pre>	<pre> CASE INDEX OF 0: BEGIN ... END; 1: BEGIN ... END;  : N: BEGIN ... END END (*CASE*);                     </pre>
3. Indefinite Loops A. Test at Beginning	<pre> 10 REM CONDITION DO 20 IF CONDITION THEN 110  : 100 GOTO 10 110 REM END WHILE LOOP                     </pre>	<pre> WHILE CONDITION DO BEGIN  : END (*WHILE LOOP*);                     </pre>
B. Test at End	<pre> 10 REM REPEAT  : 100 REM UNTIL CONDITION 110 IF NOT CONDITION THEN 10                     </pre>	<pre> REPEAT  : UNTIL ...;                     </pre>
4. Definite Loops	<pre> 10 FOR I = 1 TO N  : 100 NEXT I                     </pre>	<pre> FOR I = 1 N DO BEGIN  : (END (*FOR LOOP*);                     </pre>



# Upgrade your PET...

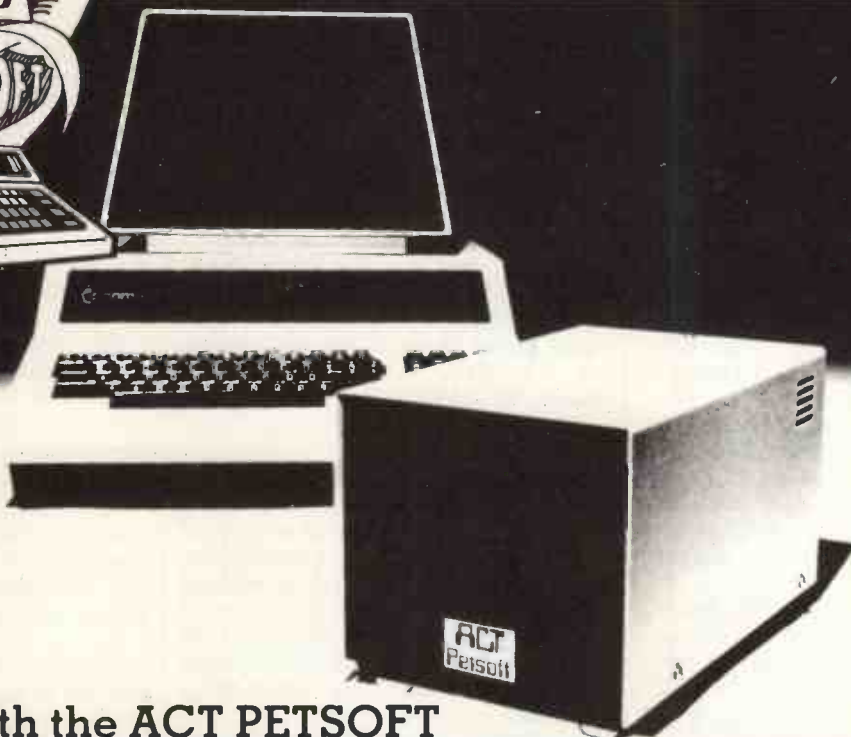

## ... with the ACT PETSOFT PROFESSIONAL DISK SYSTEM

A complete stand-alone system for the Commodore PET allowing up to 800,000 bytes of mass storage online. Designed by Compu/Think for business use, this powerful double density system offers complete random or sequential file access and support.

The Disk Operating System is in a ROM which plugs directly into 16K and 32K (new ROM) PETs, or via an Expandamem memory expansion board for 8K PETs. The Disk Operating System adds 16 extra easy-to-use commands to PETs BASIC. The Disk unit comes with a complete set of utility programs and a comprehensive manual.

★ Supported by PETACTION Business Software: Sales Accounting, Invoicing, Purchase Accounting, and soon Stock Control and Payroll

★ More memory power for your money

★ Reliable and easy to use

★ Languages supported include BASIC, 6502 Assembler, FORTH, FIFTH, PLM, PILOT, CESIL and soon FORTRAN and PASCAL

★ Wide range of PETSOFT programs including Payroll £50 + Stock Control £25

★ Supports the Pagemate Database £299

Prices exclude VAT

*up to 800K online!*

**800K** Dual headed double density dual disk for 16K and 32K (new ROM) PETs **£995**

**400K** Double density dual disk for 16K and 32K (new ROM) PETs **£840**

**400K** Double density dual disk for 8K (old ROM) PETs. Requires Expandamem **£795**

**24K** Expandamem internal expansion memory board **£320**

Prices exclude VAT.

PET is the trademark of Commodore who recommend PETACTION Business Systems.

Try the ACT PETSOFT Professional Disk System and software at your PET dealer or write to us for full details and the name of your nearest stockist.

# actPetsoft

Radclyffe House, 66-68 Hagley Road, Edgbaston, Birmingham, B16 8PF. Telephone: 021-455 8686 Telex: 339396

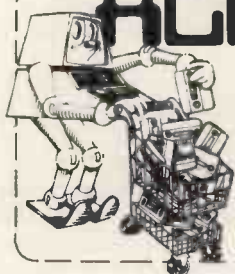

Please send me details of the PETSOFT PROFESSIONAL DISK SYSTEM

My name is \_\_\_\_\_

I live at \_\_\_\_\_

Postcode \_\_\_\_\_

I have a new/old ROM PET \_\_\_\_\_

• Circle No. 187

# Playing with money

A MODEL is a representation of the real thing. Models are used to discover the reactions of the real thing to changing conditions when it would be exorbitantly expensive, foolish, or just impossible to build the real thing and expose it to the stresses and strains it will encounter.

A corporate financial model is a representation of the operations of a company. The operations of manufacturing, selling, buying, investment, can be represented by sets of related mathematical expressions. For example, total sales equals number of units sold times price.

Price then, can be expressed as, say, cost of production, profit component, overheads, and so on. When all expressions are arranged logically and completely, a model of the company from first purchase of raw material to final nett worth is the result.

The value of such a model is apparent at budgeting time and when new ventures or changes to a company's way of doing business are mooted. Then, "what-if" questions can be put to the model and the chain reaction on all the company operations can be examined and the best course of action in the real world can be decided.

It should be obvious that the examination of a corporate financial model is best performed by using a computer. With a computer you can analyse the effects the changes make on the overall operation of the company.

## Try again

Just as quickly, you can change the parameters and provide another result to compare to the first. You continue the process until you obtain the required effect or series of effects which can be examined at leisure.

The use of computers in corporate financial modelling does not have a long history. It was only about 10 years ago that either a system or a language was made available to modellers to ease the tasks involved. Until then it was usual to program the model in a high-level language like Cobol. The handling of time-series of data, as in week-by-week or month-by-month information or calculations, was tedious and subject to error. It was when financial modelling systems and languages began offering simplified notation to handle series arithmetic that modelling was used.

Corporate models produce forecasts of financial reports, such as profit-and-loss or balance sheets but, although their overwhelming use is in financial planning, models are also used to aid marketing decisions, solve problems in distribution or production, and are used also to great effect in the evaluation of capital projects.

Financial modelling, when whole-

heartedly supported by the top management of a company, brings benefits undreamed of before the advent of the computer. It is the primary aid for decision makers.

At Carreras Rothmans in Basildon, Essex, financial modelling on the Rair Black Box microcomputer has become a key part of corporate planning activities.

Carreras Rothmans is a leading tobacco manufacturer in the U.K. and has achieved major growth in worldwide markets over last few years, receiving the Queen's Award for Exports in 1977. It began running its computerised financial model in September last year.

Financial modelling is the responsibility of the corporate planning department and comprises a three-year plan of what to sell — choosing markets, prices, determining overheads in selling — in fact, all financial aspects which could influence the profit achievement over a three-year period. As soon as one year of the plan ends, another year can be added to maintain a continuous planning process.

### Key Floyd looks at an up-to-date tool for corporate planning.

The continual company growth led to a re-structuring last year in which a number of regional business development centres were set up throughout the world. That created a need for a computer system to support the complex repetitive calculations involved in financial planning and to provide the facilities for dealing properly with "what-if" questions, thereby assisting the profit planning activities.

The information services division was given the problem of developing a suitable computer model and choosing a system to support its operation at corporate headquarters. The centralised computer installation, equipped with two ICL 1903Ts, was already utilised fully in handling the wide range of accounting, order processing and other company functions.

## Natural choice

It was also considered that installation, which is remote from corporate headquarters, would not provide the necessary degree of response and interaction through terminal activities. So microcomputers seemed the natural choice.

Ken Sayce, technical support manager of the division, was responsible for implementing the financial model on to a microcomputer. He described the reasons which led to the choice of the Rair Black Box.

"We looked at desk-top computers but decided the micro field was better for us. They were there and they were much

cheaper. We looked at the data volumes we would be using and thought that a micro could cope, so we looked at likely systems.

"The Black Box was the cheapest on the market which could do the job. Most of the others were half as expensive again and didn't have all the facilities. As far as the hardware and software were concerned, it was as good a machine as was available".

The configuration chosen has 64K of storage and is used with a 180 C/S DECwriter, a Hazeltine 1510 screen and two double-density, double-sided mini-floppy discs. Total cost was around £3,500.

The project began in June, 1978 and the financial model was up and running by September. Despite some initial problems with the internal power supply, the project went surprisingly smoothly.

As far as the information services division was concerned, the experiment gave the data processing staff some valuable experience in designing systems and

Basic programming, which none of them had done previously. Carreras Rothmans said that the most noticeable conclusions during the project were that the Black Box offered mainframe computing capabilities on a micro-scale, conditioned development staff to break-down complex problems into simple, small components and enabled programs to be amended interactively, adopting what is in effect the "what-if" approach using the Black Box equipment.

## Installing more

Carreras Rothmans is planning to supplement its existing centralised mainframe system by installing microcomputers in its various locations in the U.K. and overseas. The policy will be to use the facilities of the microcomputer where they offer the most appropriate means of meeting changing needs for business information within the company.

By committing itself to using microcomputers, Carreras Rothmans has realised the importance of using the new technology to support its continued growth.

Director of administration Keith Patterson says: "Financial modelling is important to the company for two reasons. Firstly, in planning and controlling future financial success and, secondly, in providing the knowledge and confidence to take a major step forward in planning and developing a computer service in the 1980s".

# Buy a System...Not just a "Pretty Box"

The SD System\* — From about 97p per hour (40-hour week)



**\*The SD System includes:**

SDS-200 Microcomputer T.I. 810 Printer (or equivalent) i.e., NEC SPIN WRITER £1,899. SDS 200 £4,750, T18 10 £1,499

## The SDS-200 TOTAL System features:

### System Hardware

The SDS-200 gives you features that are not found in systems costing thousands more. State-of-the-Art Engineering. Quality Production and Full Reliability testing make the SDS-200 a dependable, compact and easy to operate data processing system.

- Up to 256K Bytes RAM
- Full Keyboard with Special Accounting Key Pad
- Large 12in. Video Display Screen
- Full Cursor Control including Addressable Cursor
- Blinking, Underlining, Reverse and Protected Fields
- Uses 8in. Flexible Diskettes for Permanent Storage 2 Mbyte on-line
- Forward and Reverse Scrolling
- Capable of up to 160 Special Characters
- Expandable with Memory and Peripheral Equipment
- Will Operate as a Remote Batch Processor for Large Systems
- S 100 industry standard bus
- 4 spare S100 slots.

### System Software

A range of Business Programs are available from CAP-CPP written in Microcobal. The system will support all normal high level languages including:—

Fortran  
Cobol  
Basic  
CP/M

### Authorised dealers are:

Anglo American Computers Ltd  
Milburn House, Suite D, Dean Street  
Newcastle-upon-Tyne.  
Tel: 0632 29593

Bell Computing Ltd  
62 Lowther Street  
Carlisle 0228 43690

Picodyte  
Linton House,  
Catherine Street  
Aston, Birmingham  
Tel: 021-328 4840  
Telex: 335511

Optimal  
142 Britannia Street  
Valletta, Malta  
Tel: 356 21818  
Telex: Malta 683.

Peter McNaughton Ass.  
Anfield, Glenalmond  
Perthshire 073-888 267

Codified Computer Systems Ltd,  
69 Calabria Road,  
London N5 1HX  
Tel: 01-226 1319.

**Barcellof Ltd**  
Kimberley House,  
Vaughan Way, Leicester

UK Distributor:  
**AIRAMCO LTD**  
Unit A2, 9 Longford Avenue, Kilwinning Ind. Est.,  
Kilwinning, Ayrshire KA13 6EX.  
(0294) 57755 Telex 779808

Dealer enquiries invited

• Circle No. 188

**MICRO  
COMPUTERS  
FROM  
COMART  
COME LIKE  
THIS!**

**comart**



**comart**

**SPECIALISTS IN  
MICROCOMPUTERS**

**URGENT**

**SPECIALISTS IN  
MICROCOMPUTERS**

**comart**

**We care about what leaves  
our factory. After all it's got  
our name on it.**

The next time you want  
reliable microcomputer  
products - single card  
computers, floppy disk  
systems and disk systems -  
take a look at what we put in  
our boxes.

**A Comart Computer Catalogue will  
show you.**

Write to



**Comart Ltd., P.O. Box 2, St. Neots,  
Huntingdon, Cambs.  
Or telephone (0480) 215005.**

• Circle No. 189

# Solving the interface transfer problem

ONE LIMITATION of the Commodore Pet 2001 is that it cannot accept or transfer analogue data. The Pet interface unit described here overcomes this problem, allowing analogue information to be transferred into Pet memory and on to an XY plotter or YT pen recorder. Facilities are also available for inputting data from eight multiplexed channels and from a peak height chart reader unit.

By utilising the IEEE bus and user port lines, available at the rear of the Pet, control and data lines are formed to operate the interface unit. The user port is used for output control lines and the IEEE bus for data transfer and input control lines (figure 1).

The cost of the unit has been kept to a minimum by using slower and less accurate devices for data conversion. The ADC and DACs can, however, be uprated according to need.

## Improved reliability

The ADC can be switched to accept analogue voltages from two different sources. Firstly, from a chart reader (CR) via an offset and gain amplifier, and secondly, from an eight-channel multiplexer. A de-bounce circuit is incorporated to improve the reliability of data entry and provision is made for control of the pen lift on the XY recorder.

The ADC was built around the Ferranti ZN425E DAC, using a LM318 high slew rate op. amp as a comparator (figure 2). Once a convert command pulse has been received, the DAC counts up to the value of the analogue voltage applied to the comparator.

The comparator flips and generates a convert complete pulse. A variable attenuator is connected to the comparator

as a Full Scale Deflection (FSD) control. The clock pulses are generated by an astable CMOS chip (CD4047). A clock frequency of 250KHz allows a maximum conversion time of about 1ms.

An 8212 buffers the outputs of the ADC and controls the transfer of data on to the data highway.

The CD4051 is an 8-to-1 multiplexer with a three-bit binary counter (CD4520) connected as a decoder (figure 3). Each multiplexed input is provided with an attenuator control to prevent the multiplexer being overloaded. The various inputs are selected by pulsing the re-set and clock lines of the decoder.

## Simple switch

The simple switch de-bounce circuit uses cross-coupled gates to produce a latch which is re-set by the convert-complete pulse from the ADC. This ensures correct data entry.

An offset and gain circuit is incorporated for calibration purposes when the chart reader is in use.

To output X and Y information simultaneously, three 8212 line buffers are used (figure 4). X information is output on to the data highway and buffer 2 is clocked, storing the X data. This data is also stored in buffer 3. Y information is then transferred on to the data highway and is stored only in buffer 4, since buffer 2 is not clocked. The outputs of buffers 3 and 4 are then enabled and the data is converted via the DACs to the X and Y outputs. Internal pre-sets set the FSD of the DACs.

A read relay driven by a transistor buffer (BC182L) allows remote control of the pen lift on the XY recorder. Power supply rails are derived from a Vero 3 rail

power supply providing +5V at 500 mA and -5V at 50 mA.

The software to control the Pet interface unit is written as subroutines which can be added to any Basic program. They are:

- **Output routine** — GOSUB 2000 (See GOSUB 2300). Allows the pen to move to any position, set by X and Y.  $0 \leq X \leq 255, 0 \leq Y \leq 255$ . Variable N9 is set automatically, depending on whether the pen up or pen down routines are executed first.
- **Pen down** — GOSUB 2100. The pen is put down and N9 is set, allowing the pen to stay down while executing the output routine.
- **Pen up** — GOSUB 2200. Similarly the pen is put up and N9 set accordingly.
- **Zero start for output routine** — GOSUB 2300. To be executed before output routine. It sets all control lines for output mode and need only be used at the beginning of a program.
- **Delays** — GOSUB 2400, GOSUB 2410, GOSUB 2420. These are loops which act as delays. They enable the XY plotter to draw lines and dots at the correct time. To change the delay, alter the final value of J9. The delay lengths are short, medium and long respectively.
- **GOSUB 2410** is also used in other sub-routines.
- **Axis routine** — GOSUB 2500. This draws the axes of a graph with calibration markers. A choice of three positions for both X and Y are available — X axis — top, centre, bottom; Y axis — left, centre, right.

To obtain the calibration markers, enter the maximum value and number of increments for each axis. If not

(continued on next page)

Figure 1. Block diagram of Pet interface unit.

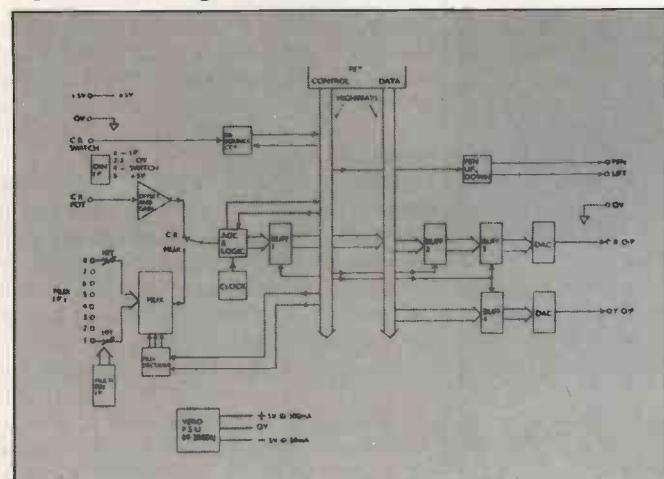
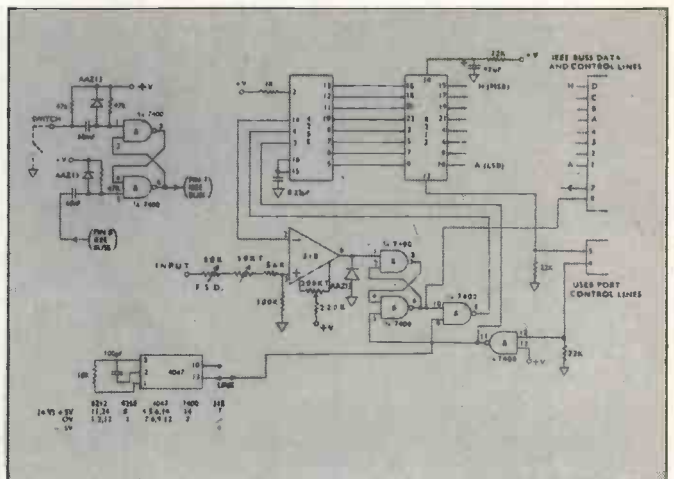

Figure 2. I/P interface board Pet 2.



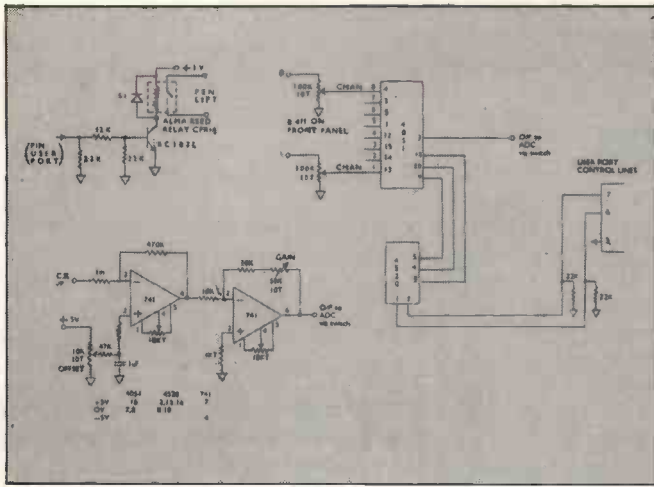

Figure 3. I/P interface board Pet 3.

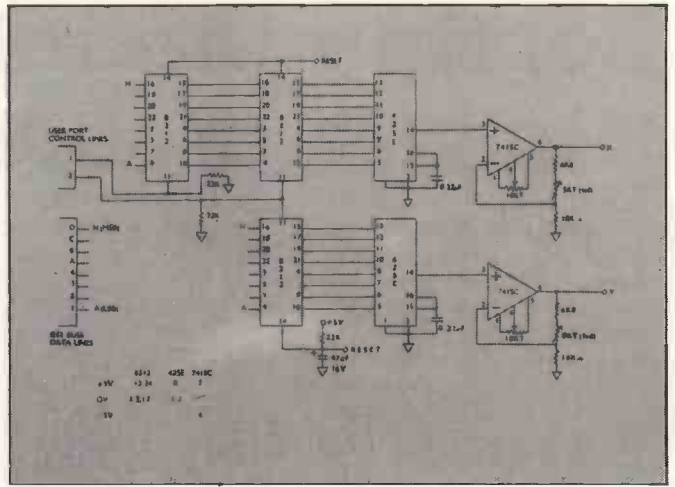

Figure 4. O/P interface board Pet 1.

(continued from previous page)

- required, entre 0 for the number of increments.
- **Delay** — GOSUB 2800. Similar to other delays but shorter in time. It is also used in other subroutines.

```

10 DIM C(12,12)
20 GOSUB 3100:GOSUB 2910
30 FOR A=0 TO 11
40 FOR B=0 TO 11
50 GOSUB 3000:C(A,B)=P
60 NEXT B
70 NEXT A
80 PRINT"DATA INPUT COMPLETE"
90 PRINT"OUTPUTTING DATA NOW"
100 Y=C(0,0):X=0:GOSUB 2000:GOSUB 2100
110 FOR A=0 TO 11
120 FOR B=0 TO 11
130 PRINT C(A,B):Y=Y+1:X=X+255/144
140 Y=C(A,B):GOSUB 2000
150 NEXT B
160 NEXT A
170 GOSUB 2200
180 STOP
  
```

Figure 7.

- **Wait for Chart Reader**—GOSUB 2900. Pet is instructed to WAIT until the chart reader (CR) switch is closed. All keyboard control of Pet is lost until the switch is closed. To break the program, depress STOP and close the CR switch simultaneously.
- **Re-set multiplexer** — GOSUB 2910. The multiplexer is re-set to channel 1.

Figure 5. Wiring the inter-connecting leads.

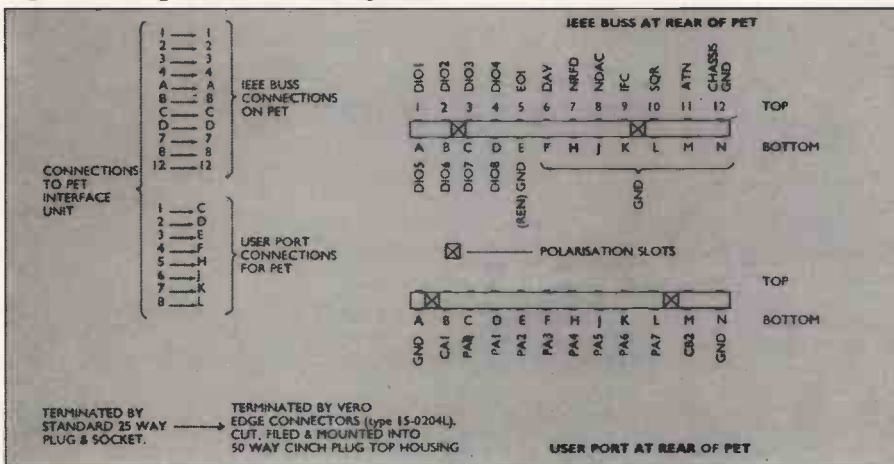

- **Clock multiplexer**—GOSUB 2920. The multiplexer is incremented one channel every clock pulse.
- **Input routine**— GOSUB 3000 (See GOSUB 3100). The ADC is instructed to convert its input, whether MUX or CR, into binary form. Variable P becomes equal to the binary value.  $0 \leq P \leq 255$ . If the value exceeds 255, the ADC will not convert.
- **Zero start for input routine**—GOSUB 3100. To be executed before the input routine. It sets all data lines for input mode. It must precede GOSUB 3000 or incorrect input data will be recorded. Variables used in subroutines 2000 - 3100 are X, Y, P, A9\$, B9\$, D9, E9, F9, G9, H9, I9, J9, K9, L9, M9, N9, R9, S9, T9, U9, V9, W9, Z9, IX9, IY9, MX9, MY9.

The printed circuit boards layouts available from the author — are manufactured in the usual way. After the relevant components have been assembled on to the boards, the front panel should be drilled. The various components are mounted on to the front panel and wired to the relevant PCB edge connectors. Figure 5 shows details of how to wire the inter-connecting leads from Pet to the interface unit.

The power supply unit used in the prototype is the Verospeed 3 rail power

supply which is mounted on to the PCB card Pet 4 and wired.

Additional mains filtering may be required to remove unwanted glitches from the power supply lines. Standard inductor or inductor/capacitor filters are sufficient.

The prototype was designed originally and built into a half-rack case to aid easy expansion of the system if required. However, the case alone adds considerably to the cost of the unit and could be replaced by a less expensive one.

Very little setting-up is required since the interface unit is mostly digital. After

```

10 GOSUB 3100
20 GOSUB 2910:GOSUB 3000
30 PRINT P:GOTO 20

10 GOSUB 2300
20 STOP
30 X=255:Y=255:GOSUB 2000
40 STOP
  
```

Figure 8.

the unit has been switched on and any major mistakes in wiring have been corrected, turn all pre-sets to their central position and all controls on the front panel fully anti-clockwise. Enter the sub-routine program in figure 6 and save on tape of disc and then enter the program shown in figure 7.

Execute both programs to check that most, if not all the functions are working correctly. By applying a biased sinewave to channel 1 of the multi-plexer and increasing the gain control to obtain a reasonable swing, the XY plotter should plot the incoming waveform.

To calibrate the instrument, enter the first of the two programs shown in figure 8. Execute the program and adjust the offset pre-sets on board Pet 1 so that the X and Y outputs read 0.00V exactly.



Erase line 1 and re-run the program, adjusting the f.s.d. pre-sets so that the X and Y outputs read 4.00V.

Adjust the offset pre-sets on board Pet 3 for each 741 in turn while monitoring their respective outputs. This should be done only when the offset and gain controls are turned down.

To alter the offset and FSD presets on board Pet 2, enter and run the second program shown in figure 8. The equivalent voltage applied to the input of the ADC should be converted to a number between 0 and 255 and displayed on the screen. Short the ADC input to ground (CHI) and adjust the offset pre-set until 0 is displayed.

Check, if possible, the output of the 318 and set to 0.00V. With the MUX gain

controls and the ADC FSD control turned fully clockwise, apply the minimum FSD voltage to CHI and adjust the FSD pre-set to obtain 255 on the screen. If in doubt, alter the pre-set so that it is effectively short-circuit. Re-run the test program in figure 7 to check that the unit is functioning correctly.

This interface unit should prove to be a very useful addition to the Pet. It has various limitations, however, some of which are discussed.

Under Basic control, the maximum sampling rate of the ADC is limited to 8Hz. This is decreased further to 1Hz when all eight channels are being multiplexed. The sampling rate can be increased by more than 50 times when Pet is under machine code control.

The ADC operates only in a standard binary code and hence will only accept positive-going signals. Its maximum input voltage depends on the setting of the FSD control and also on the passive gain controls connected to the multiplexer inputs. Offset controls were omitted for simplicity and cost.

When using the chart reader, maximum voltage swing and resolution is obtained firstly by adjusting the offset control and then adjusting the gain and FSD controls located on the front panel. In the MUX mode, only the FSD control is functional.

The Pet interface unit is designed as an economical instrument to aid data transfer to and from the Pet. It costs about £250 to construct, including a half-rack Vero case. It has numerous applications and the software is expandable easily to suit many requirements.

Figure 6. Subroutine program.

```

2000 POKE 59426,X
2010 POKE 59471,N9+1:POKE 59471,N9
2020 POKE 59426,Y
2030 POKE 59471,N9+2:POKE 59471,N9
2040 RETURN
2100 GOSUB 2410:POKE 59471,4:GOSUB 2410
2110 N9=4:RETURN
2200 GOSUB 2410:POKE 59471,3:GOSUB 2410
2210 N9=3:RETURN
2300 POKE 59459,255:POKE 59426,0
2310 POKE 59471,3:POKE 59471,3
2320 RETURN
2400 FOR J9=3 TO 150:K9=J9:NEXT:RETURN
2410 FOR J9=3 TO 330:K9=J9:NEXT:RETURN
2420 FOR J9=0 TO 500:K9=J9:NEXT:RETURN
2500 INPUT"WHERE DO YOU WANT YOUR Y AXIS,L,C,R"?A9$:PRINT
2520 IF A9$="L"THEN D9=0:P9=3:S9=2:GOTO2552
2530 IF A9$="C"THEN D9=127:P9=129:S9=125:GOTO 2552
2540 IF A9$="R"THEN D9=255:P9=255:S9=252:GOTO 2552
2550 GOTO 2500
2552 INPUT"MAXIMUM Y VALUE":MY9:PRINT
2554 INPUT"Y INCREMENTS":IY9:PRINT
2556 L9=255/MY9:MY9=L9
2560 INPUT"WHERE DO YOU WANT YOUR X AXIS,T,C,B"?B9$:PRINT
2580 IF B9$="T"THEN E9=255:V9=255:T9=250:GOTO 2612
2590 IF B9$="C"THEN E9=127:V9=129:T9=125:GOTO 2612
2600 IF B9$="B"THEN E9=0:V9=4:T9=3:GOTO 2612
2610 GOTO 2560
2612 INPUT"MAXIMUM X VALUE":MX9:PRINT
2614 INPUT"X INCREMENTS":IX9:PRINT
2616 M9=255/MX9:MX9=M9
2620 X=D9:Y=0:GOSUB 2000:GOSUB 2000:U9=0
2630 GOSUB 2100
2640 FOR F9=0 TO 255
2650 H9=H9+1:Y=H9-1:GOSUB 2000
2660 IF Y=INT((IY9*MY9)*I9) THEN GOSUB 2700
2670 NEXT:GOSUB 2200:GOSUB 2000
2690 Y=E9:X=0:GOSUB 2000:GOSUB 2000:U9=3
2700 GOSUB 2100
2710 FOR G9=0 TO 255
2720 I9=I9+1:X=I9-1:GOSUB 2000
2730 IF X=INT((IX9*MX9)*U9) THEN GOSUB 2820
2740 NEXT:GOSUB 2200:GOSUB 2000
2760 X=0:Y=0:GOSUB 2000
2770 RETURN
2780 GOSUB 2400:X=S9:GOSUB 2000:GOSUB 2000:X=P9:GOSUB 2000:
GOSUB 2000:X=D9:GOSUB 2000
2790 U9=U9+1:GOSUB 2400:RETURN
2800 FOR Z9=0 TO 90:M9=Z9:NEXT:RETURN
2820 GOSUB 2400:Y=V9:GOSUB 2000:GOSUB 2000:Y=T9:GOSUB 2000:
GOSUB 2000:Y=E9:GOSUB 2000
2830 U9=U9+1:GOSUB 2400:RETURN
2900 WAIT 59456,64,254:RETURN
2910 POKE 59471,64:POKE 59471,3:RETURN
2920 POKE 59471,32:POKE 59471,3:RETURN
3000 POKE 59471,8:POKE 59471,0
3010 WAIT 59456,1,255
3020 POKE 59471,16
3030 P=PEEK(59424)
3040 POKE 59471,0
3050 RETURN
3100 POKE 59426,255:POKE 59459,255
3110 RETURN
    
```

## Components list

- 3 off ZN425E DAC
- 2 7415C High-slew rate 741
- 4 8212 8-bit latch
- 1 LM318 High-slew rate op. amp.
- 2 7400 Quad 2 input NAND
- 2 741
- 1 4051 8-channel MUX
- 1 4047 Astable
- 1 4520 Dual binary counter
- 4 10K Presets (10 turn)
- 1 200K Presets (10 turn)
- 1 50K Presets (10 turn)
- 2 5K Presets (10 turn)
- 8 100K Potentiometers (10 turn)
- 1 10K Potentiometers (10 turn)
- 2 50K Potentiometers (10 turn)
- 1 BC182L NPN Transistor
- 3 AAZ13 Ge diode
- 1 IN3062 Si diode
- 1 CPRI/J Alma Reed Relay (5v)
- 1 1uF 35V tant
- 2 47uF 16V tant
- 6 22uF 25V tant } de-coupling on PCBs
- 1 0.1uF 100V
- 2 68nF
- 3 0.22uF
- 1 100pF
- 10 22K All resistors 1/4w 5%
- 1 56K
- 1 12K
- 3 10K
- 1 4K7
- 5 47K
- 1 1M
- 1 470K
- 1 1K
- 1 100K
- 1 220K
- 2 18K
- 2 6K8
- 5 8 PIN DIL sockets
- 3 14 PIN DIL sockets
- 5 16 PIN DIL sockets
- 4 24 PIN DIL sockets
- 1 3 rail power-supply (Vero electronics type 89-20886)
- 1 1/2 rack vero case (3U)
- 1 1/2 rack sub frame (3U)
- 1 Mains switch
- 1 25 way plug, socket and cover (R.S.)
- 1 20mm fuse holder
- 4 0.1in. single-sided edge connectors 43 way (Vero or R.S.)
- 11 10 turn pot. knobs.
- 1 9-way plug, socket and cover
- Various 4mm Banan sockets } depending on design and application
- 1 S.P.D.T. min. toggle switch
- General hardware

# Hard-sectoring approach under examination

MOST disc file-handling techniques used in industry and commerce are the esoteric pursuits of software development teams, resulting in sophisticated operating systems. The applications programmer needs to know only how to present information to the operating system to access many types of files.

To the hobbyist, however, the implementation of a disc-based system may become a nightmare, especially with limited disc space and without a clear understanding of basic file types. It is hoped this article will be of assistance in this area and of general interest to users of existing systems.

A file is a contiguous set of records, held usually on contiguous sectors of a disc. For simplicity, let us assume that all records are of equal length and that records do not span sector boundaries. Figure 1 shows a disc file of eight records each of 128 bytes in length using two sectors of disc space.



Figure 1.

As its name implies a floppy disc is a flexible circular disc, coated with a magnetic oxide. As the disc rotates the read/write head — or heads for double-sided discs — can read or change the magnetic patterns stored by the oxide. The available storage surface of a disc is split into tracks and sectors. A track is a complete annulus of the recording surface. A sector is a part of a track.

As the disc revolves, the read/write head can move to any track on the available recording surface. A photo cell detects light shining through the start sector holes to show the location of any sector on any track. Each sector can store about  $512 \times 8$  bits of information, by magnetising the oxide in two directions — zeros or ones.

**In the first of two articles, B R White looks at techniques for handling files on discs.**

This organisation of sectors by their physical position on the disc is known as hard sectoring and has been until now the most common storage technique. On request by the CPU, a given sector is either read into memory or written to disc from memory.

The other approach is called soft sectoring. The position and length of each sector on a track is controlled by software, which writes a start sector marker followed by the sector data and an end sector marker. This can be useful in terms of compatibility for hardware supplied by different manufacturers since the hardware, under program control, will seek the information required independently of its physical location.

Very complex file-handling techniques are common to both hard- and soft-sectored systems and for the sake of simplicity the remainder of the article will assume a hard-sectoring approach.

Let us assume we start with a blank disc and know only how to read or write sectors to and from memory. How do

we build to a multi-file disc system?

First, a disc directory is needed which is usually the first one or two sectors of the disc. For each file created on the disc there is a corresponding entry in the directory containing at least the basic information to access the file:

- Alphanumeric file name or perhaps only a file number.

- Start sector.
- Number of records.
- Number of bytes per record.
- Various pointers.

It is advisable to leave room for extra information in each directory entry, since it may be useful as your system expands. For example, a pass number to allow access to the file, the number of 'live' records in the file, and the like.

Most disc-based systems use more than one type of file, since information needs to be stored in different ways and retrieved in the most efficient manner.

To understand how information is held on a multi-file system, the concept of 'file pointers' must be grasped clearly. A pointer is an integer number held as an element of a record on disc, which refers either to another record on the same file or a record on another file. These pointers are used by programs to follow 'drains' of records via any number of files either to:

- Add a new record to a chain.
- Access an existing record in a chain.
- Update an existing record in a chain.
- Delete an unwanted record from a chain, maintaining the integrity of any remaining records in the chain.

There is an exception to the definition of a pointer which is called the 'null' pointer. This is where the pointer held on a record or used in memory by a program must not "point" anywhere.

Direct files are by far the fastest method of random access on disc systems. Suppose you require a customer file of, say, 200 records and it is convenient to code your customer account numbers in the range 1-200. Assume a sector length of 512 bytes and a record length of 128 bytes. Figure 2 shows how this file would be held on disc.

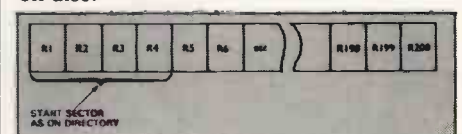
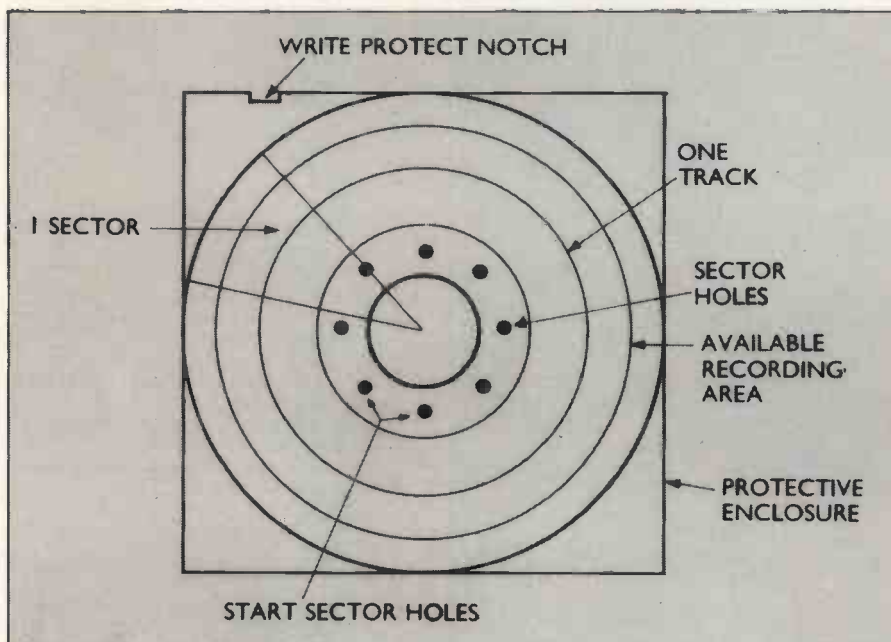

Figure 2.

To calculate the sector containing any



record in the file requires the simple algorithm:

$$\frac{(\text{Record number} - 1)}{\text{Records per sector}} + \text{start sector}$$

The remainder of the division will be in the range 0 to (records/sector - 1), hence the byte position within the sector is the remainder multiplied by the number of bytes per record.

The record can be processed either within the single sector disc buffer, since its position is known, or can be copied to a record buffer within the program where the memory address of each element within the record will be same as for any other record from the file. (See figure 3).

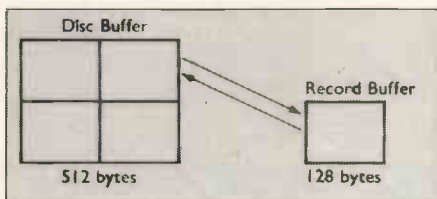

Figure 3.

This technique of using record buffers is common, since after accessing the desired record the disc buffer may be used again to access a record from another file, thus reducing the memory requirements for a multi-file system.

Before copying the record buffer to the disc buffer, the original sector must be read back into the disc buffer to retain the records adjacent to the record being written or re-written to disc. For example, suppose we read record 3 (R3) from our customer file in figure 2. The disc buffer will contain R1, R2, R3 and R4 and the record buffer will contain R3.

If R3 is to be updated with information from other files sharing the common disc buffer, then R1, R2 and R4 will be lost, so the same sector must be re-read from disc before copying R3 back to its original position and re-writing all four records.

Unless record lengths are of the form  $2^n$  (i.e. 1, 2, 4, 8, 16, 32, 64, 128, 256, 512) there will be wasted space at the end of each sector. This can be saved by allowing records to span sector boundaries and by using different algorithms to calculate the record position. The disc buffer, however, must then be at least two sectors, even if the record length is only three bytes. (See figure 4).

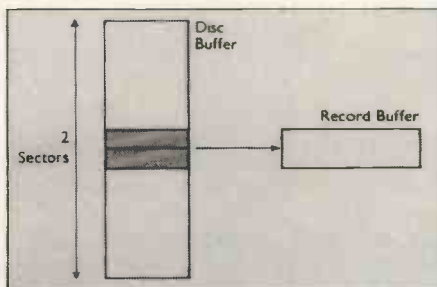

Figure 4.

A serial file is a contiguous set of records, held in contiguous record 'slots'. The determination of the sector and byte

position is exactly the same as for a direct file. In fact, a serial file is similar to a direct file, except that it starts empty and records are written to it starting at one end.

Figure 5 shows a serial file containing five records each 16 bytes in length.

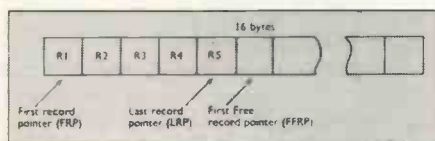

Figure 5.

This file utilises the file pointers mentioned previously which are stored on the disc directory. Before accessing the file, the current state of these pointers must be determined and returned correctly to the directory after the file has been used. A serial file is useful to record events during processing which do not require immediate action.

For example, suppose from our customer file (figure 2) we need a monthly printout showing customers who have exceeded their credit limit during the month. The programs which update customer balances will be 'aware' of those occurrences and need only to write the relevant details to the serial file.

To write a new record, (say R6, figure 5) the new record is written to the slot determined by the FFRP; the LRP then becomes the FFRP used and the FFRP is incremented to point to the next slot.

### Serial access

When reading the file, each record is accessed serially from the start of the file to the record preceding the FFRP. The FRP and LRP are superfluous in this case but I have used them to maintain continuity with other file types requiring pointers.

To clear the file, the pointers on the directory need only to be re-set so that they do not point to any record on the file — i.e. the null pointer. Some systems use slot numbers starting at 1, so 0 (zero) is convenient as the null pointer. Where slot numbers start from zero, a bit pattern is used as the null which is recognised by the software and obviously must not equate to a valid slot number.

The processing of direct and serial files is determined by the physical position of records on a file. Although they have distinct advantages for many applications they can become cumbersome in others. Many file-processing techniques require more volatile and flexible environments. Linked files remove the restriction of strict physical processing and incorporate the concept of a logical record sequence by using pointers on each record to indicate where the next logical record is. Within linked files there are two 'chains' of records — the record chain and the free chain. See figures 6(a) and 6(b).

The null pointer in figure 6(a) denotes the end of the file and theoretically will never be used in a volatile file, since the file would be full. The null pointer in figure 6(b) held in R27, indicates the end of the logical chain of records which, in the diagram, are in physical and logical sequence. Note that in this case the record numbers (R1 - R27) are not synonymous with the slot numbers used but their logical position is determined by the pointers in the record chain.

Suppose we wish to add record 16 (R16) to this record chain which must be preceded by R8 and followed by R21. R8 must point logically to the new R16 and R16 must point to R21. Since there is no physical space between R8 and R21, the first free record must be used to hold R1 as shown in figure 6(c).

Though the records are not in physical sequence, they are in logical sequence since the pointers held on each record maintain the integrity of the record chain. The FFRP takes the value held by the pointer in the record to which it was pointing originally. This will always be the rule when using a linked file.

Returning to figure 6(b), suppose we wish to delete R8, R7 then must point logically to R21. Figure 6(a) shows how R8 is removed from the record chain and released to the free chain for future use.

There are four further possibilities for insertions and deletions with this type of file:

- Deletion of record denoted by FRP.
- Deletion of record denoted by LRP.
- Insertion of record logically preceding FRP.
- Insertion of record at end of record chain.

To avoid any confusion at this stage, each case is shown separately (6e to 6h) with the rules governing the update of the pointers. Again, assume a start condition as in figure 6(b).

The FRP now points to the record which was pointed to by the record which has been deleted. As in figure 6(a) the FFRP is set to the slot which has been deleted and its link is updated accordingly to the value of the old FFRP.

In this case the LRP is set to the record which preceded logically R27. Record 21 is now the last record in the chain and has its pointer set to null. The FFRP is updated in the normal manner.

The FFRP becomes the link from the record to which it pointed and the FRP is set to the old FFRP. The pointer in R0 becomes the old FRP. In this case the last record on the file precedes the first although the logical sequence is still intact.

After insertion of R35, the FFRP again becomes the link from the record to which it pointed. The null from R27 is changed to point to the record which was the old FFRP. The new record has a null pointer and the LRP becomes the old FFRP.

*(continued on next page)*

(continued from previous page)

With linked files which have a large number of insertions and deletions, although the logical sequence is maintained, the physical sequence can be lost completely, resulting in slower response times, since logically-adjacent records may be separated by many sectors. It is necessary to re-organise the file periodically, where possible, to keep the system speed to a maximum. The technique of re-organisation will be considered when discussing Indexed Sequential Files.

Linked files as described are rarely used

in isolation unless the file size is small or the response times are of no importance. For example, to access a record in the middle of the record chain, one has to start reading from the FRP logically until the required record is found. It is much more practical and often necessary to use linked files in relation to other file types where their speed and flexibility are utilised most efficiently.

In part II I will discuss these file processes to describe the following commonly-used file types:

- Partially-linked files
- Indexed sequential files

- Pooled files
- Spooled output files.

To the hobbyist who wishes to write file-handling software using these concepts, I would suggest a start at direct files only, since most files require the calculation of sector and byte position. The software requirements for files using record links and/or directory pointers generally share common sub-routines used independently of the file type to be processed, so it would be a good idea to understand (a) to (g) above before attempting an integrated file control program.

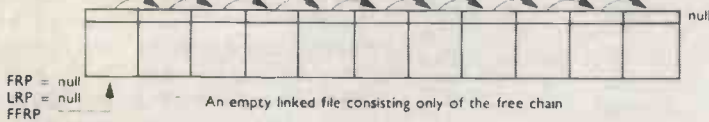

Figure 6 (a).

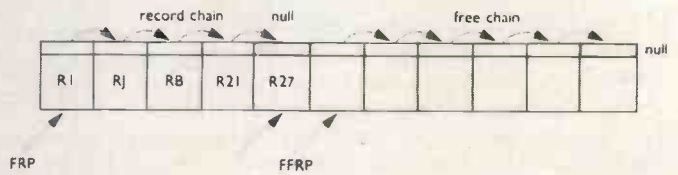

Figure 6 (b).

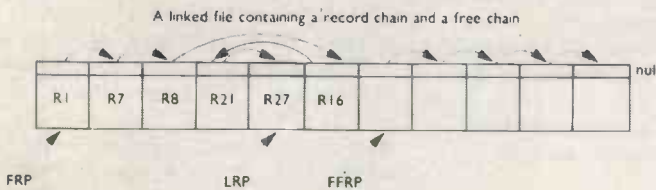

Figure 6 (c).

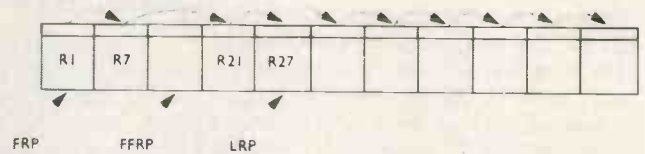

Figure 6 (d).

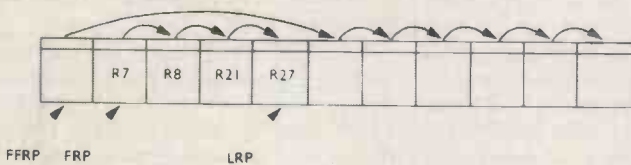

Figure 6 (e).

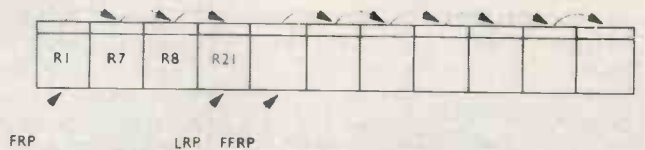

Figure 6 (f).

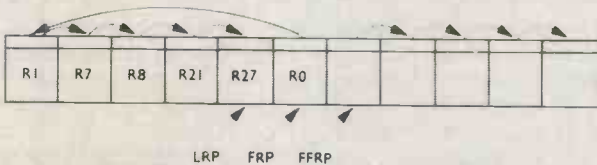

Figure 6 (g).

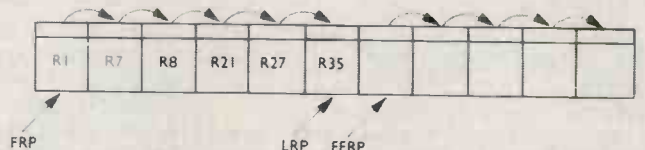

Figure 6 (h).

# Process of testing for failures

YOU'VE BOUGHT your microcomputer and it's working well, but will it work forever? What do you do if it stops completely? Even worse, what if it works sometimes, but produces garbage at other times? Obviously, it's broken, but how do you find the fault?

I will outline some of the faults which may occur, and show how suitable programs can identify, and sometimes locate, the fault in a corrupt system. I will outline the types of IC failure which may occur, and the broad way in which they can be found. Once we understand the failure modes, we can set-up an ideal test philosophy; and I will give 8080 assembly language programs to test a practical micro.

SSI/MSI and LSI chips fail in similar

**David Peckett, a professional designer of automatic test equipment, describes how even the wonder-chip can give problems and what to do about it when it does.**

ways but with different effects. Because no point in even an MSI device is more than one or two gates away from a pin, faults will almost invariably force a pin to a logical '1' or '0', and hold it there. These are called 'stuck-at-1' (s-a-1) and 'stuck-at-zero' (s-a-0) faults.

A failure deep inside an LSI chip, however, won't usually cause a 'stuck-at'. Only when suitable data passes through the device will the fault appear, and then only for a few clock cycles. Such faults are called 'soft' faults, and are usually 'pattern-sensitive'.

Soft faults in memory chips are straightforward to find — invariably cause a bit to be s-a-1 or s-a-0. Soft, pattern-sensitive, faults in less-structured LSI devices, such as microprocessors and USART, however, can be much more difficult to find. LSI devices can, of course, suffer from hard, stuck-at, faults as well as soft faults

## Two stages

A software 'self-test' of a microcomputer has two principal stages. Initially it must check for stuck-at faults; the second phase looks for identifiable soft faults, particularly in the system memory. It is also possible to use software to detect a partially-failed microprocessor, or to check-out I/O devices, but the technique is too complex to cover in this article.

Since the microprocessor communicates with the rest of the system via the address and data busses, they must be checked as fully as possible before doing anything more subtle. Unfortunately, any program will be corrupted by a faulty data bus, so we have to assume that this is in order. We would need special test equipment to find data bus faults.

Although we can often detect a failed address line, it is often more difficult to output the test result, since the corrupt line may well make it impossible to run I/O routines. Having made sure, as far as

practicable, that there are no hard faults, we can look for soft faults, particularly in the memory.

● **Memory testing:** Most faults in RAMs force single bits permanently to '1' or '0'. Those faults can be located easily by writing, and then reading, all '0's and all '1's to the RAM. An s-a-1 or s-a-0 bit will be glaringly obvious. Less often, however, RAMs can show pattern-sensitivity, in which faults depend on the data in the

holding all the others at zero. 'Walking a 0' is obviously the reverse of this process. Using these tests, virtually any soft fault in RAM can be found.

● **Test program considerations:** The details of the test program, and the faults it can find, particularly the possibility of indicating address bus faults, obviously depend on the system being tested. Certain principles are generally true.

An address line may have 20 devices attached to it; an s-a-0 caused by any of those chips will hold the line at zero. The only 'simple' way to find the faulty device is to change each possible IC in turn; it would be a rare system in which self-test software could go 'beyond the node'. If no blatant stuck-at faults exist, the memory can be tested and, if required, the other LSI chips also checked.

## Short as possible

The self-test program must be as short as possible; to run at all it assumes that the data bus and the microprocessor work correctly. The address bus test must use the minimum number of address lines to access the program.

All the tests must, wherever possible, use only the internal microprocessor registers, since the state of the system RAM is unknown. Equally, if the program is in RAM, it should be as short as possible to reduce the chance of it being corrupted by a faulty memory chip. If the self-test routine is re-locatable, it could be re-loaded into a different area of memory if it were corrupted in its original location.

A more reliable approach would be to use a PROM, either plugged-in as needed or permanently on-board, to hold the self-test software. Since the program operates mainly on single bits and must be very short, it must be written in machine code. If it were written in Basic, or any other high-level-language, it would probably be so long that most faults would corrupt the program, rather than being found by it.

Any stand-alone test program relies on the data bus and the microprocessor working correctly. The bus would be easy to check — write and read  $00_{16}$  and  $FF_{16}$  to and from any memory location. Unfortunately, any possible program to do this would be corrupted by a stuck data bus line. It is not even possible to carry out the test via the monitor, because a faulty data bus would corrupt the monitor. The first stage, therefore, is to check the address lines and, if possible, try to indicate any fault. If the address bus is in order the RAM can be tested.

● **Testing the address bus.** This test must

(continued on next page)

chip. There are many complex and lengthy tests to find this type of defect and the test for any particular chip depends on the physical layout of its memory cells.

Straightforward, but effective, tests for any design of RAM, however, are 'walking a 1' and 'walking a 0'. This means that we clear the memory, and then try to set each bit, in turn, to '1', while

Figure 1. Address bus test.

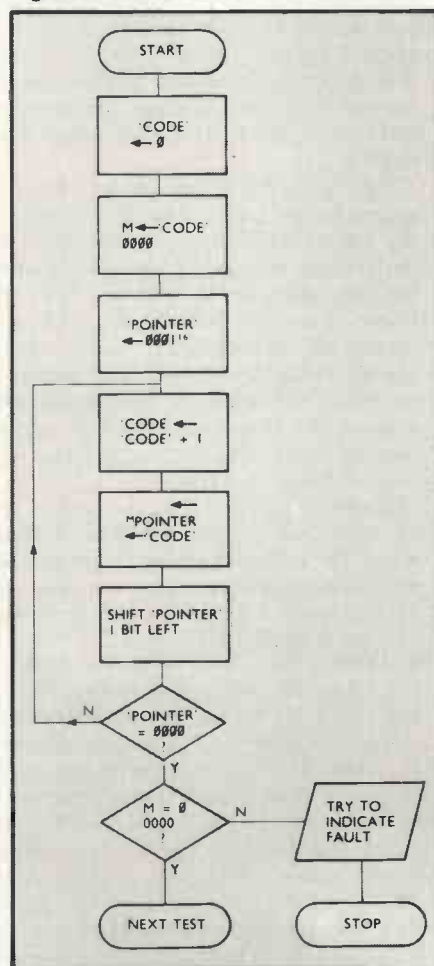
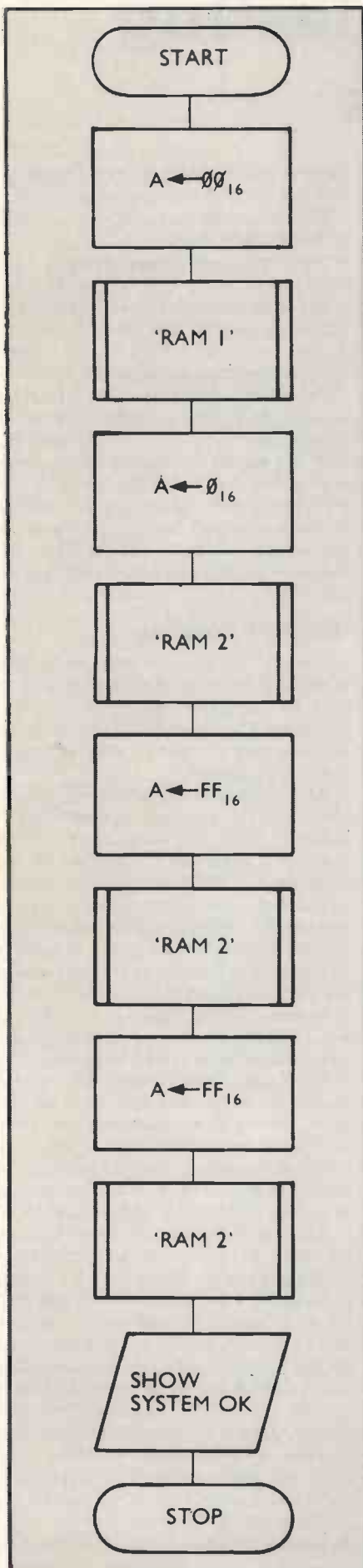

Figure 2. Main program for RAM test.



(continued from previous page)

check that each line can be set to '1' and '0' independently of all other lines. The simplest way to do this, assuming 16 address lines ( $A_0 - A_{15}$ ) is to write, in turn, to memory locations  $0000_{16}$ ,  $0001_{16}$ ,  $0002_{16}$ ,  $0004_{16}$ ,  $0008_{16}$  . . .  $4000_{16}$ ,  $8000_{16}$  — a total of 17 write cycles. For each cycle, a different code (e.g., 1-17) is loaded into memory. By then reading address 0000 only and checking the code, any faulty lines can be identified.

For instance, suppose line  $A_3$  is s-a-0. Then, when  $0008_{16}$  is addressed, the code (e.g., 4) is loaded into address 0000, overwriting the existing code (1) at that location. The following test would expect  $0000_{16}$  to contain 1 but would find 4. Alternatively, if  $A_3$  was s-a-1, reading 0000 would read the 4 in  $0008_{16}$ . Either way, the faulty address line could be identified easily. If there is a fault, the program should attempt to display it and then stop.

### Specially adapted

Obviously, this technique can be used only for addresses in RAM and must be adapted to suit specific systems. It could be extended to test addresses in ROM by, e.g., reading address  $0100_{16}$  and checking for the correct code (e.g., A8). Figure 1 is a flow chart for the general test.

● **RAM test.** Once we are content with the address bus, we can test the RAM. Remember that this test will check that the memory can be cleared and set to all '1's, and will walk '1' and '0' round the RAM. It is obviously convenient to walk the '1' immediately after clearing the memory and to walk the '0' after setting each byte to  $FF_{16}$ .

Any failing bit will be obvious and the address of the fault known. With this data and a knowledge of the physical layout of the memory board(s), it is easy to identify the failed chip, and to replace it. Since we know that the address bus is not corrupted, the program can be long enough to display a short fault message. As before, the details of the program will depend on the system being tested. General flowcharts for the program are given in figures 2, 3 and 4.

Having decided what tests are necessary, we can write code to perform them. The following examples are in 8080 assembly language. They would, of course, run on a Z-80 but would not make best use of its abilities.

● **Address test.** The flowchart of figure 1 is for a system with 64K of RAM. This is not very likely but the general program is shown in figure 5. The routine requires  $17_{10}$  bytes of RAM, plus the display function, and thus cannot test address lines  $A_0-A_4$ , which must be satisfactory for it to run. It therefore tests lines  $A_5-A_{15}$  and the index register (H,L) is initialised to  $0020_{16}$ . A clear run causes a jump to the next test, otherwise the program tries to show the fault. The display procedure will

be dependent entirely on the target system; you must assess the best way to write it.

You may well have to modify the program further. It can test only the RAM addresses in your system; calls to ROM

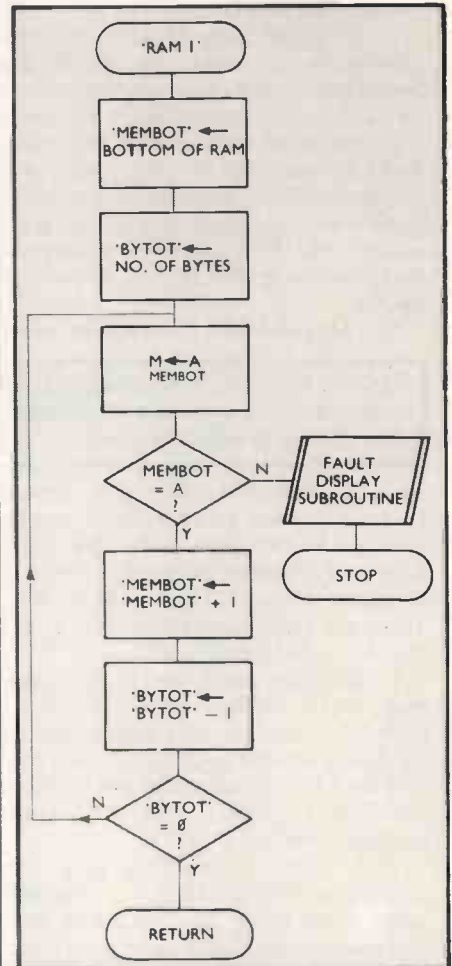

Figure 3. RAM 1 subroutine.

addresses are best checked by making sure the correct data is found, e.g:

```

MOV A,M
CPI A8
JNZ 'FAULT'
  
```

In practical terms, this means that the test is really useful only for systems with a good deal of RAM in them.

● **RAM test.** Figure 6 is an 8080 program for the RAM test of figures 2-4. As you can see from the code, the program uses all the internal registers of the 8080 and only the stack is in RAM. This means that the maximum amount of RAM can be tested. The program, unfortunately, is not re-locatable — it is very cumbersome to achieve this with a 8080 (unlike, e.g., a 6800).

Thus if you do not use a self-test PROM, you may need two versions of the code, so that if the first load is corrupted, you can put it somewhere else in the memory. The program assumes that the stack is at the top of memory, and the (H,L) register is set initially to the lowest address to be tested. It is then incremented through the RAM, testing each byte.

A failure, or a satisfactory test, produces

calls to subroutines 'FLTIND' and 'DISPLY' respectively. I have not defined them, since they will depend on your own system and its output. They should be easy to write, however; on a failure (H,L) contains the failing address and A contains what should have been in it.

Two areas of the code may need a little explanation. In the 'walking bit' tests, register C is used to re-set each byte to 00 or FF at the end of the byte's test. Without this, the byte would stay at the last value to which it was set, either 80 or 7F. Either way, the program fault cover would be reduced, as the test relies on every bit in the RAM being set to '0' as a '1' is walked, and vice-versa.

The second detail is the way of controlling the outer loops of 'RAM1'

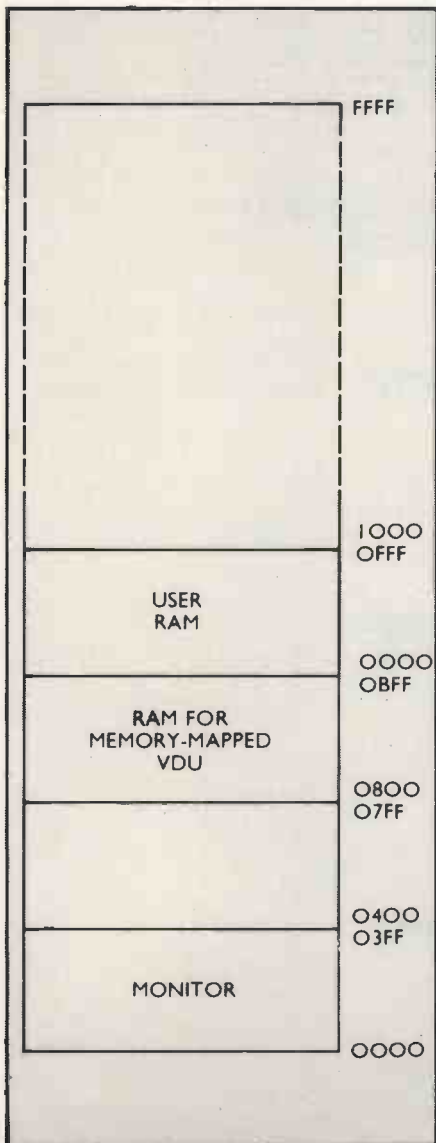

Figure 7. Possible system memory map.

and 'RAM2' via (D,E). The 8080 does not set flags as the 16-bit register (D,E) is decremented through zero; we cannot, therefore, use this for the jump test.

Instead, D and E have to be decremented separately, with the high byte, D,

(continued on next page)

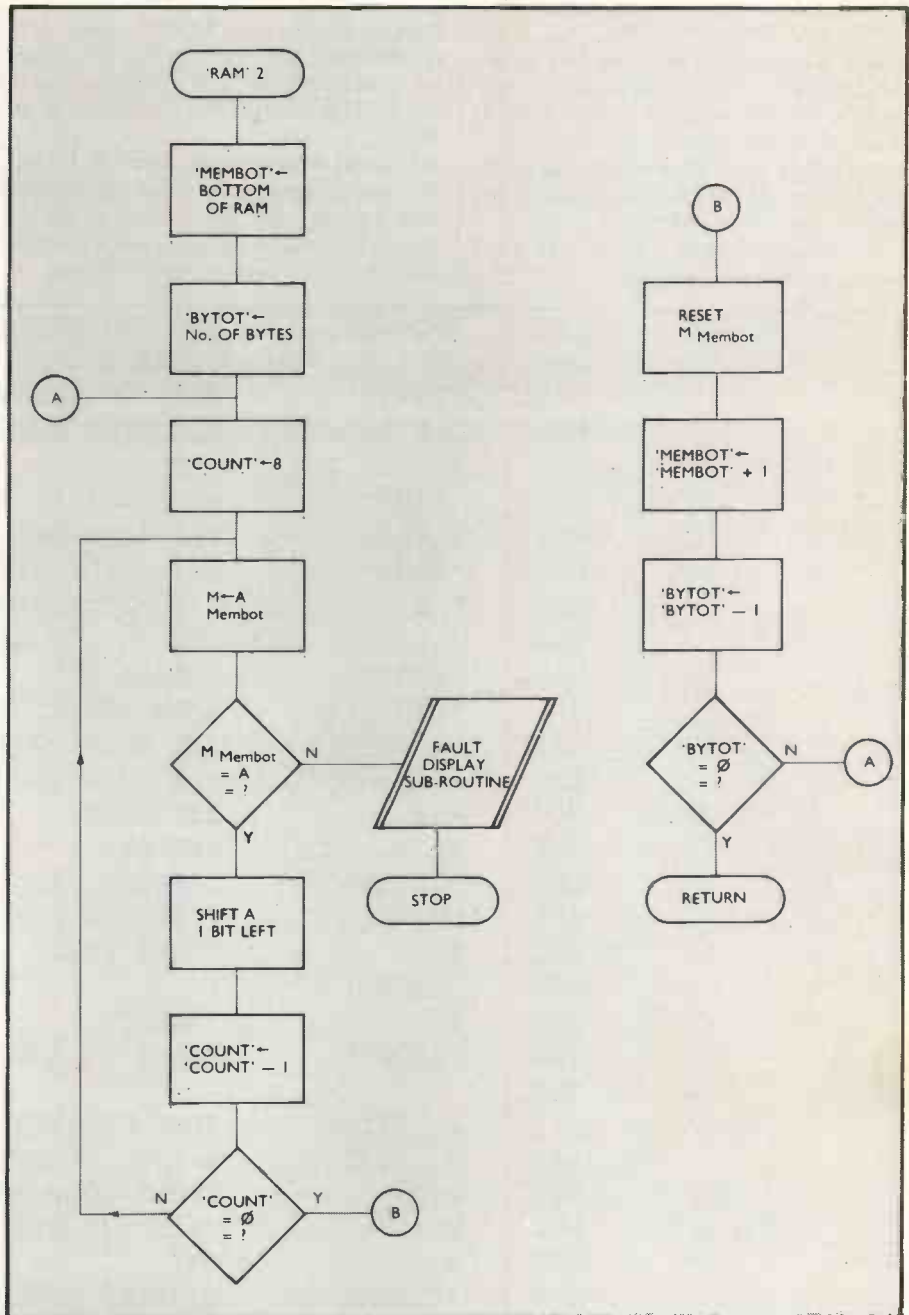

Figure 4. Walking bit test.

Figure 5. Address test program.

```

LXI    H,0020    H,L USED FOR ADDRESSING
XRA    A        SET A TO 0
STA    0000     SET 000016 TO 0
'LOOPA'
INR    A
MOV    M,A      SHIFT H ONE BIT LEFT
DAD    H
JNC    'LOOPA'
MOV    A,M      H,L NOW AT 0000
CZ     'NXTST'  GO TO NEXT TEST IF OK
:                          TRY TO SHOW FAULT
    
```

(continued from previous page)

being decremented each time E passes through zero. The return from the subroutine is made when D reaches zero. D must therefore contain the number of times E is to reach zero, which is given by the number of times that E is decremented wholly or partly to 00 from FF.

To achieve this, D is set to one more  
**Figure 6. RAM test program.**

than the high byte in 'BYTOT' unless E is initially zero. For example, if 079F<sub>16</sub> bytes are to be tested, set (D,E) to 089F<sub>16</sub>, but if 'BYTOT' is 0400<sub>16</sub>, then (D,E) should be 0400<sub>16</sub>.

● **Systems with separate areas of RAM.**  
 The test program is designed for systems with a single, contiguous, area of RAM. This is not always the case; some systems have two or more separate blocks of

RAM, while in others it is difficult to load programs directly into the lowest RAM addresses (figure 7). Nevertheless, we must still test all the memory ICs.

We can convert the program of figure 6 into a subroutine, with the size of each RAM block ('BYTOTx') and its start address ('MEMBOTx') passed as variables. Figure 8 shows one way of doing this. The two variables are passed in registers (D,E)

	LXI	SP,abcd	abcd IS TOP OF MEMORY
	XRA	A	CLEAR A
	CALL	'RAM1'	TEST TO CLEAR MEMORY
	MOV	C,A	CLEAR C FOR 'RAM2'
	INR	A	A TO 01
	CALL	'RAM2'	WALK A '1'
	MVI	A,FF	SET A TO FF
	CALL	'RAM1'	SET EVERY BIT TO '1'
	MOV	C,A	C TO FF FOR NEXT TEST
	DCR	A	SET '0' TO WALK ROUND
	CALL	'RAM2'	WALK A '0'
	JMP	'DISPLAY'	SHOW RESULT IS OK
'RAM1'	LXI	D,'BYTOT'	SET LOOP COUNTER. SEE TEXT
'LOOP1'	LXI	H,'MEMBOT'	H,L TO START ADDRESS
	MOV	M,A	SET BYTE
	CMP	M	SET OK?
	CNZ	'FLTIND'	DISPLAY FAULT
	INX	H	POINT TO NEXT BYTE
	DCR	E	COUNT DOWN
	JNZ	'LOOP1'	
	DCR	D	"CARRY"
	JNZ	'LOOP1'	COUNT TO ZERO?
	RET		
'RAM2'	LXI	D,'BYTOT'	LOOP COUNTER
	LXI	H,'MEMBOT'	H,L TO START ADDRESS
'LOOP2'	MVI	B,08	INNER LOOP COUNTER
'LOOP3'	MOV	M,A	WALK ONE BIT
	CMP	M	OK?
	CNZ	'FLTIND'	DISPLAY FAULT
	RLC		SHIFT A
	DCR	B	
	JNZ	'LOOP3'	ANOTHER BIT?
	MOV	M,C	RESET BYTE
	INX	H	POINT TO NEXT BYTE
	DCR	E	COUNT DOWN
	JNZ	'LOOP2'	
	DCR	D	"CARRY"
	JNZ	'LOOP2'	COUNT TO ZERO?
	RET		
'FLTIND'	:		SHOW FAULT
	:		
	:		
	:		
	:		
	RET		
'DISPLAY'	:		SHOW SYSTEM IS OK
	:		
	:		
	:		



and (H,L) of the 8080; the first act of the subroutine is to store them in suitable locations, such as the first four bytes of memory. The data is then available for the 'RAM1' and 'RAM2' subroutines.

With the memory map of figure 7, addresses 0C00<sub>16</sub>—0C03<sub>16</sub> could be used as 'STORE1' and 'STORE2', with the program starting at 0C04<sub>16</sub>. The stack

Figure 8. Testing several block of RAM.

pointer should be set to 1000<sub>16</sub>, and the two areas of RAM are that for the memory-mapped VDU, and the remains of the user RAM. The necessary test is then straightforward.

## Conclusions

- Microcomputers are fine when they work; they are, however, bound to fail from time to time. Since a major source of

failures will be the LIS chips in the system, we must design suitable tests for them.

- It is particularly easy to use software to test the RAM in the system and the single failed chip normally can be identified directly.

- In principle, it is also possible to test automatically the address lines but the system configuration may well prevent this.

	LXI	SP,abcd	abcd IS TOP OF MEMORY
	LXI	H,'MEMBOT1'	START OF FIRST BLOCK
	LXI	D,'BYTOT1'	NO OF BYTES IN FIRST BLOCK
	CALL	'MEMTST'	TEST FIRST BLOCK
	LXI	H,'MEMBOT2'	START OF SECOND BLOCK
	LXI	D,'BYTOT2'	NO OF BYTES IN SECOND BLOCK
	:	:	TEST NEXT BLOCK(S)
	:	:	:
	JMP	'DISPLAY'	SHOW RESULT IS OK
'MEMTST'	SHLD	'STORE1'	SAVE START OF BLOCK
	XCHG		
	SHLD	'STORE2'	SAVE NO OF BYTES
	XRA	A	CLEAR A
	CALL	'RAM1'	
	:	:	
	:	:	AS FIGURE 6
	:	:	
	CALL	'RAM2'	
	RET		
'RAM1'	LHLD	'STORE2'	
	XCHG		D,E TO NO OF BYTES
	LHLD	'STORE1'	H,L TO START OF BLOCK
'LOOP1'	MOV	M,A	SET BYTE
	:	:	
	:	:	AS FIGURE 6
	:	:	
	RET		
'RAM2'	LHLD	'STORE2'	
	XCHG		D,E TO NO OF BYTES
	LHLD	'STORE1'	H,L TO START OF BLOCK
'LOOP2'	MVI	B,08	INNER LOOP COUNTER
	:	:	
	:	:	AS FIGURE 6
	:	:	
	RET		
'FLTIND'	:	:	
	:	:	SHOW FAULT
	:	:	
	RET		
	RET		RETURN FROM 'MEMTST'
'DISPLAY'	:	:	
	:	:	SHOW SYSTEM IS OK
	:	:	

# Three Trumps from Acorn



## Acorn Controller

Designed as an industrial controller module, it is based on the 6502 CPU with 2K Eprom, 1.25K ram and 32 I/O lines. In eurocard format it is provided with an onboard monitor (2 x 7AS571) giving comprehensive development and debugging facilities. Also available in minimum configuration for low cost OEM applications.

**STOP PRESS**  
FULL COLOUR  
TELETEXT MODULE  
NOW AVAILABLE  
RING FOR DETAILS

## The Acorn Microcomputer

The Acorn controller module mounted beneath a matching eurocard with hex keyboard, 8 digit seven segment display and CUTS tape interface requires only a single unswitched power supply to form the powerful Acorn microcomputer.

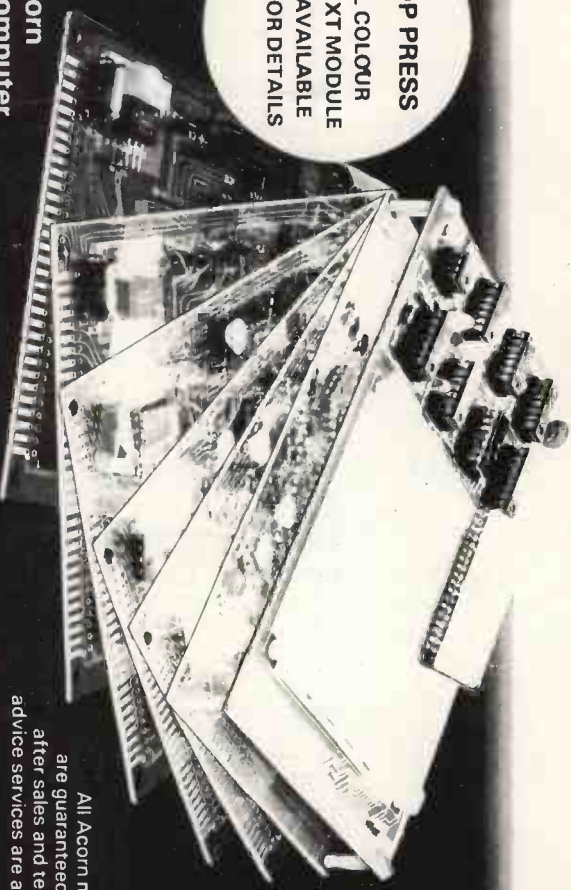

Although designed for expandability the Acorn Microcomputer is a complete development system for the Acorn controller and together with the Acorn Users Manual provides the perfect introduction to hex programming; the carefully optimised monitor has the following functions:

- System Program
- Set of sub-routines for use in programming
- Powerful debugging facility displays all internal registers
- Tape load and store

## Acorn Memory

The first in our series of expansion cards is the Acorn 8K + 8K "state of the art" memory module. On a matching eurocard it provides 8K of ram (2.114) and 8K of Eprom (2.732) or 4K of Eprom (2.716). It requires a single 5V rail, is designed for direct connection via a 32 way edge connector to the Acorn bus and is fully buffered for wiring into any system. Two onboard sockets provide independent positioning of Eprom and ram.

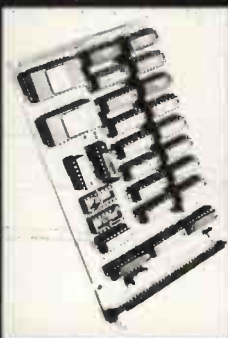

## Order form

Send to: Acorn Computers Ltd. 4A Market Hill, Cambridge, Cambs.

- (qty) Acorn Microcomputer(s) in kit form at £65.00 plus £5.20 VAT
  - (qty) Acorn Microcomputer(s) assembled and tested at £75.00 plus £6.00 VAT
  - (qty) Acorn controller(s) (minimum configuration) at £35.00 plus £2.80 VAT
  - (qty) Acorn Memory(s) assembled and tested at £95.00 plus £7.60 VAT
- N.B. Price shown is for full 8K of ram, prices for smaller memory options and Eprom additions available on request.
- Enclose a cheque for £..... made out to Acorn Computers Ltd.

Name \_\_\_\_\_  
Address \_\_\_\_\_

Reord No  
1403810

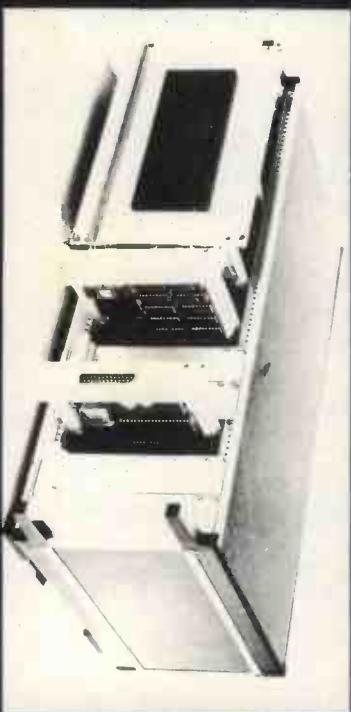

Software available soon includes 4K Editor-Assembler-Disassembler, 4K Proprietary Fast Basic, Disc operating system with full file handling. Although a standard strip of

veroboard is all that is required for a full backplane, a racking system can be made available by Acorn Computers. The rack shown includes the VDU interface, two memory cards and dual floppy disc interface.

# RAIR

- High speed 8085 microprocessor ●
- Priority interrupts and DMA ●
- 64K bytes of RAM memory ●
- Transparent ROM bootstrap loader ●
- Integral dual minifloppy disks ●
- Programmable serial I/O interfaces ●
- Advanced floppy disk operating system ●
- Serial and random file processing ●
- Macro assembler with symbolic debugging ●
- Extended BASIC interpreter ●
- Relocating FORTRAN IV compiler ●
- ANS 74 COBOL compiler ●
- Comprehensive range of peripherals ●
- UK wide on-site maintenance ●
- Quantity and OEM discounts ●
- Leasing and rental facilities ●

#### New features

- Double sided/density disks (260K bytes/drive) ●
- High speed hardware arithmetic unit ●
- Multi-user operating system support ●
- Dual-drive add-on (over 1M byte on-line) ●



RAIR BLACK BOX  
MICROCOMPUTER



## BLACK BOX MICROCOMPUTER

30-32 NEAL STREET COVENT GARDEN LONDON WC2H 9PS TELEPHONE 01-836 4663

# Keen Computers have an Apple base nearer to you!



Apple II 16K	830.00
Additional 16K RAM	69.00
Applesoft ROM	110.00
RS232 Card	110.00
SuperColour	90.00
Disk Drive and Controller	425.00
Disk Drive w/o Controller	385.00
Corvus 11MB Disk	3500.00
Speechlab	140.00
Apple Clock	140.00
Supertalker	190.00
Printers from	450.00

Software packages are available for most business applications.

A few are:

Word Processor, Addressing + Mailing, General Ledger, Sales Ledger, Purchase Ledger, Incomplete Records Accounting, Stock Control, Payroll, Estate Agents.

All prices are subject to change without notice.

#### Apple Bases

**Nottingham**  
Keen Computers Ltd.  
Tel: 0602 583254

**Derby**  
P.T.S. (Electronics) Ltd.  
Tel: Derby 43592

**London**  
Adda Computers Ltd.  
Tel: 01-579 5845

Sumlock Bondain Ltd.  
Tel: 01-250 0505

**Leicester**  
Arden Data Processing Ltd.  
Tel: 0533 22255

**Scunthorpe**  
Computer Facilities Ltd.  
Tel: 0724 63167

**Edinburgh**  
Microcentre Ltd.  
Tel: 031 225 2022

**Kettering**  
H.B. Computers Ltd.  
Tel: 0536 83922

**Barrow-in-Furness**  
Furness Computer Services Ltd.  
Tel: 0229 24621

**Stoke-on-Trent**  
Tekdata Ltd.  
Tel: 0782 813631

**Tamworth**  
Abel Computer Systems  
Tel: 0827 895309

**Birmingham**  
C.P.S. Data Systems Ltd.  
Tel: 021 707 3866

**Northampton**  
Ford & Wright Ltd.  
Tel: 0604 39660

**Sheffield**  
Datron Interform Ltd.  
Tel: 0742 585490

**Newcastle-upon-Tyne**  
P.I.P.S. Computer Services  
Tel: 0632 482359

**Canterbury**  
M. D. Wright Data Services Ltd.  
Tel: 0227 69090

**Newbury**  
Newbear Computing Stores  
Tel: 0635 30505

 **keen computers ltd**

5b the poultry  
Nottingham  
Tel: 0602 583254  
Telex: 37297 (keenco)

● Circle No. 192

100

# Data — the sword of peace is yours

THIS VERSION of the Kingly Orb was adapted for the 380-Z using XDB by Bennet and Adam Laurie. There may be a problem on other machines caused by function definitions, as at lines 90,100. Those functions may have to be inserted explicitly or done as GOSUBs.

Line 340 is a Print Using alert; if your Basic does not have it, print the integers of X1, X2. Watch for double =, as in line 150. You may have to write: P1 = 2: P2 = 9 'S' in line 120 sets your power.

Good luck, and may megabyte powers be with you.

```

10 CLEAR 1000
20 ?"DO YOU WANT INSTRUCTION
5?"(YES,NO OR SPELLS)";
30 INPUT A#
40 IF A#="YES" THEN GOSUB 19
60
50 IF A#="SPELLS" THEN GOSUB
  2340
60 GOSUB 2400
70 DIM A(100,3),D(5)
80 L=1
90 DEF FNR(X)=INT(X*RND(25))+1
)
100 DEF FND(X,Y,X1,Y1)=50R((X
-X1)*(X-X1)+(Y-Y1)*(Y-Y1))
110 P=3
120 S=500
130 C0=0
140 D=999
150 P1=P2=9
160 FOR I=1 TO 100
170 A(I,1)=FNR(10)
180 A(I,2)=FNR(3)
190 NEXT I
200 X1=X2=FNR(100)
210 D1=FNR(100)
220 D2=FNR(100)
230 IF D1=X1 OR D2=X2 THEN 210
240 IF FNR(1000)>600 THEN 270
250 I=FNR(100)
260 GOTO 490
270 REM
280 IFC0<1 THEN 330
290 D=FND(X1,X2,D1,D2)
300 IFC0<2 THEN 330
310 P1=SGN(D1-X1)
320 P2=SGN(D2-X2)
330 PRINT USING 340;X1,X2
340 !YOU ARE AT ### ###
350 IFC0<1 THEN 390

```

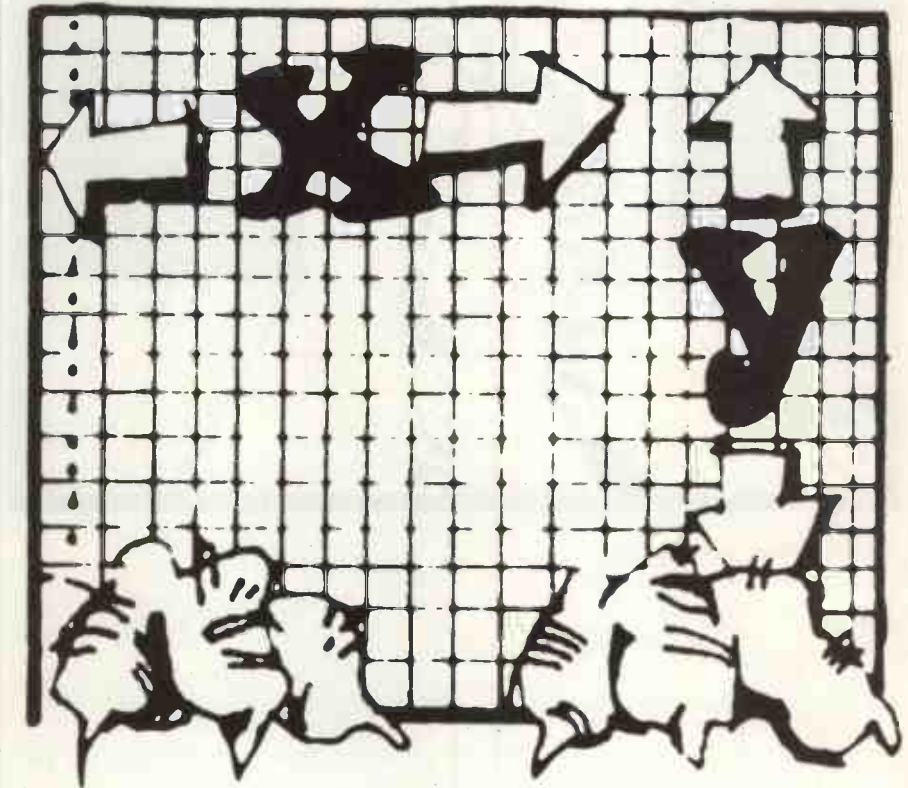

```

360 ?" AND ARE ";INT(D);"AW
AY FROM THE MAGIC SPOT"
370 IFC0<2 THEN 390
380 ?"YOUR COMPASS READS ";P
1:P2
390 IF D=0 THEN 1000
400 IF C0>0 THEN 420
410 ?
420 ?"DIRECTION";
430 INPUT C1,C2
440 IF FND(X1,X2,X1+C1,X2+C2
)>20 THEN 1400
450 X1=X1+C1
460 X2=X2+C2
470 GOSUB 1520
480 GOTO 240
490 REM
500 READ C#(1),C#(2),C#(3)
510 FOR J=1 TO A(I,1)
520 READ B#;S0
530 READ D(0),D(1),D(2),D(3)
,D(4)
540 NEXT J
550 RESTORE
560 S0=S0*L

```

```

570 T=A(I,2)
580 IF S<=30*L OR P<10 THEN
  600
590 T=2
600 ?"YOU HAVE FOUND A";C0*(T
);" ";B#;" WITH POWER ";S0
610 ON T GOTO 640,700,620
620 IF FNR(10)<5 AND (S<=30*
L OR P<10) THEN 640
630 GOTO 930
640 C0=C0+1
650 IF C0>3 THEN 670
660 ON C0 GOTO 710,730,750
670 IF S<L*30 THEN 750
680 ?"YOU HAVE BEEN TAUGHT S
PELL NUMBER";P+1
690 P=P+1
700 GOTO 270
710 ?"YOU HAVE BEEN GIVEN A
DISTANCE METER"
720 GOTO 270
730 ?"YOU HAVE BEEN GIVEN A
COMPASS"

```



(continued on next page)



(continued from previous page)

```

740 GOTO 270
750 ?"YOUR STRENGTH HAS BEEN
  INCREASED"
760 S=S+50*L
770 GOTO 270
780 D3=S-50
790 IF D3<0 THEN 930
800 ?"WHAT SPELL NUMBER?";
810 INPUT U
820 IF U=0 OR (U>10 AND U<10
  +L AND L>1) THEN 1200
830 IF U>P OR U<0 THEN 890
840 FOR I2=1 TO 5
850 IF D(I2)=U THEN 880
860 NEXT I2
870 IF FNR(5) <>3 THEN 1060
880 GOTO 910
890 ?"YOU CANNOT USE THAT SP
  ELL"
900 GOTO 800
910 S0=S0-U*10
920 IF S0<=0 THEN 970
930 P3=S0/10/L
940 U=FNR(INT(P3))
950 ?"THE ";B#;" USES A SP
  EL NUMBER ";U;" ON YOU"
960 S=S-U*10
970 ?" YOU HAVE A STRENGTH O
  F ";S
980 IF S0<=0 THEN 1030
990 IF S>0 THEN 800
1000 ?"YOU HAVE FAILED IN YO
  UR QUEST. YOU WERE FOULY"
1010 ?"MURDERED BY A ";B#;".

```

```

  BAD LUCK."
1020 STOP
1030 ?"THE ";B#;" IS NO MORE
  . ONCE MORE THE POWERS OF GO
  OD WIN THROUGH."
1040 ?"NOW CONTINUE WITH YOU
  R QUEST."
1050 GOTO 270
1060 ?"YOUR SPELL HAD NO AFF
  ECT"
1070 GOTO 930
1080 ?"YOU ARE STOOD ON THE
  MAGIC SPOT"
1090 READ A#,A#,A#
1100 FOR I=1 TO 10
1110 READ A#,A#,A#,A#,A#,A#
1120 NEXT I
1130 FOR I=1 TO L
1140 READ A#
1150 NEXT I
1160 RESTORE
1170 ?A#
1180 L=L+1
1190 IF L=6 THEN 1250
1200 IF P=10 THEN 1230
1210 ?"EXTRA WISDOM MEANS TH
  AT YOU KNOW SPELL ";P+1
1220 P=P+1
1230 ?"YOU HAVE BEEN TRANSPO
  RTED TO ANOTHER LEVEL"
1240 GOTO 200
1250 STOP
1260 IF U>P THEN 1570
1270 ?"DIRECTION TO RUN IN"
1280 INPUT A,B
1290 IF FND((X1,X2,X1+A,X2+B)
  <=20 THEN 1320

```

```

1300 ?"YOU CANNOT GO THAT FA
  R"
1310 GOTO 1270
1320 X1=X1+A
1330 X2=X2+B
1340 GOSUB 1520
1350 IF FNR(1000)>600 THEN 1
  380
1360 ?"THE ";B#;" HAS NOT FO
  LLOWED YOU"
1370 GOTO 240
1380 ?"THE ";B#;" IS IN HOT
  PURSUIT"
1390 GOTO 930
1400 ?"YOU CANNOT GO THAT FA
  R"
1410 GOTO 290
1420 X1=1
1430 GOTO 1490
1440 X1=100
1450 GOTO 1490
1460 X2=1
1470 GOTO 1490
1480 X2=100
1490 S=S*.9
1500 ?"YOU HAVE BUMPED INTO
  A WALL AND LOST 10% OF YOUR
  STRENGTH"
1510 RETURN
1520 IF X1<1 THEN 1420
1530 IF X1>100 THEN 1440
1540 IF X2<1 THEN 1460
1550 IF X2>100 THEN 1480
1560 RETURN
1570 S(U-10)=S(U-10)+1
1580 IF S(U-10)=1 THEN 1610
1590 ?"YOU HAVE ALREADY USED
  THAT OBJECT OF STATE "
1600 GOTO 800
1610 IF U=11 AND B#="ROCK MO
  NSTER" THEN 1670
1620 IF U=12 AND B#="MUMMY"
  THEN 1670
1630 IF U=13 AND B#="GIANT"
  THEN 1670
1640 IF U=14 AND B#="WIZARD"
  THEN 1670
1650 ?"THE ";B#;" IS UNDA
  MAG ED"
1660 GOTO 930
1670 IF FNR(1000)<100 THEN 1
  650
1680 ?"THE OBJECT OF STATE W
  ON"
1690 GOTO 1040
1700 DATA " GOOD","N EVIL","
  NEUTRAL"
1710 DATA DRAGON,57
1720 DATA 4,6,7,9,10
1730 DATA WITCH,25

```



1740 DATA 2,3,5,8,10  
 1750 DATA WIZARD,82  
 1760 DATA 2,3,5,8,10  
 1770 DATA VAMPIRE,12  
 1780 DATA 4,6,7,9,10  
 1790 DATA ROCK MONSTER,36  
 1800 DATA 4,7,8,9,10  
 1810 DATA MUMMY,47  
 1820 DATA 3,6,8,10,2  
 1830 DATA GOLD HORSE,78  
 1840 DATA 3,4,6,10,8  
 1850 DATA SAND MAN,34  
 1860 DATA 1,4,10,7,5  
 1870 DATA GIANT,75  
 1880 DATA 18,3,6,8,7  
 1890 DATA WATER WORM,38  
 1900 DATA 10,8,3,2,1  
 1910 DATA YOU HAVE FOUND THE GREAT RING  
 1920 DATA YOU HAVE FOUND THE KINGLY ORB  
 1930 DATA THE ROBES OF STATE ARE YOURS  
 1940 DATA THE SWORD OF PEACE IS YOURS  
 1950 DATA YOU ARE NOW THE TRUE MONARCH OF OZ  
 1960 ?"YOU ARE THE CROWN PRINCE OF OZ."

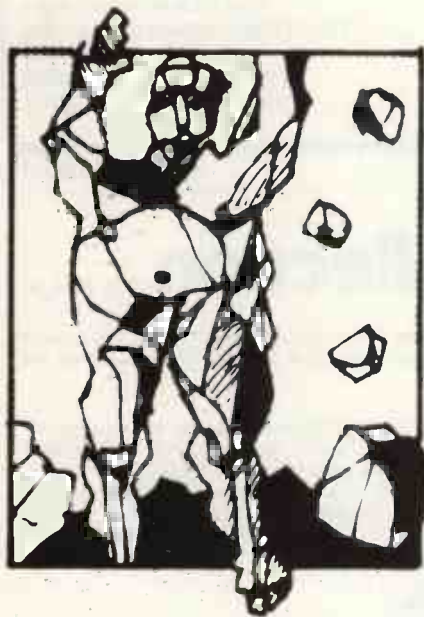

1970 ?"TO PROVE THAT YOU ARE WORTHY OF THE TITLE OF MONARCH, YOU MUST PASS A TEST. YOU ARE CAST INTO A DUNGEON TO FIND FOUR OBJECTS OF STATE. THESE ARE HIDDEN ON ONE PAVING SLAB ON EACH DUNGEON LEVEL."  
 1980 ?"THIS IS KNOWN AS THE MAGIC SPOT. EACH DUNGEON LEVEL IS 100 SLABS BY 100 SLABS IN SIZE. YOU MAY TRAVEL 10 SLABS IN ANY DIRECTION. DIRECTION IS GIVEN BY THE VECTOR (X,Y). INPUT THIS (WITHOUT THE BRACKETS) WHEN ASKED FOR DIRECTION. YOU MAY MEET "  
 1990 ?"VARIOUS MONSTERS ON YOUR QUEST. NEUTRAL MONSTERS MAY ACT AS GOOD OR EVIL. GOOD

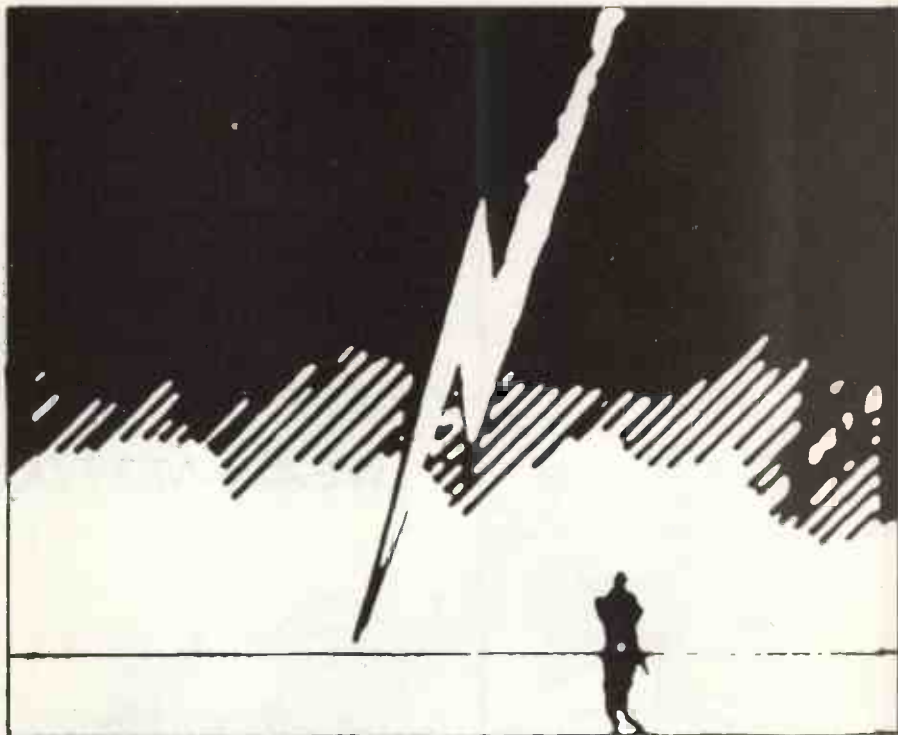

MONSTERS WILL GIVE YOU THINGS WHICH WILL DO YOU GOOD. THE FIRST WILL GIVE YOU A DISTANCE METER WHICH WILL SHOW HOW FAR AWAY FROM THE MAGIC SPOT YOU ARE. (YOU CAN "  
 2000 ?"FIND THE MAGIC SPOT WITH ONLY THIS.) THE SECOND MONSTER WILL GIVE YOU A COMPASS TO SHOW YOU THE DIRECTION TO GO (X,Y) THESE ARE -1,0 OR 1. ALL SUBSEQUENT MONSTERS EITHER GIVE YOU ANOTHER SPELL OR MORE STRENGTH IF YOU NEED IT."  
 2010 ?" EVIL MONSTERS ON THE OTHER HAND TRY TO KILL YOU. THEY CAST SPELLS ON YOU WHICH LOWER YOUR STRENGTH. YOU DO THE SAME FOR THEM. IF EITHER OF YOUR STRENGTHS DROP BELOW ONE YOU ARE DEAD."  
 2020 ?" BY CASTING SPELL 8 YOU MAY RUN AWAY FROM THE MONSTER HE MAY OR MAY NOT FOLLOW YOU. IN WHICH CASE YOU HAVE LOST YOUR CHANCE TO CAST A SPELL."  
 2030 ?" AS YOU COLLECT THE OBJECTS OF STATE YOU MAY USE THEM TO DESTROY ONE MONSTER PER OBJECT. EACH OBJECT IS TUNED TO ONLY ONE SPECIES AND HAS A 10% CHANCE OF FAILURE."  
 2040 ?"TO USE THE OBJECTS OF STATE TYPE SPELL NUMBERS 11 TO 14 FOR:"  
 2050 ?"GREAT RING, KINGLY ORB, ROBES OF STATE, SWORD OF PEACE RESPECTIVELY"  
 2060 ?"MONSTERS ARE NOT SUSCEPTIBLE TO ALL OF THE SPELLS. AT FIRST YOU CAN ONLY USE 5 SPELLS 1,2 AND 3."  
 2070 ?" WHEN YOU REACH THE

FIFTH MAGIC SPOT YOU WIN."  
 2340 ?"THE SPELLS ARE:--"  
 2350 ?"(1)LANDSLIDE (6)MAKE SWAMP"  
 2360 ?"(2)WIND (7)RAIN OF HOLY WATER"  
 2370 ?"(3)FIREBALL (8)EARTHQUAKE  
 2380 ?"(4)MAKE POOL (9)RAINSTORM  
 2390 ?"(5)CREATE HOLE (10)THUNDERSTORM"



2400 ?"THE OBJECTS OF STATE DESTROY:"  
 2410 ?"GREAT RING==ROCK MONSTER"  
 2420 ?"KINGLY ORB==MUMMY  
 2430 ?"ROBES OF STATE==GIANT"  
 2440 ?"SWORD OF PEACE==WIZARD"  
 2450 RETURN  
 2460 ?"GOOD LUCK, YOUR IMPERIAL HIGHNESS!"  
 2470 ?"(YOU'LL NEED IT)"  
 2480 RETURN

# AT LAST

WE HAVE COMPLETED OUR MOVE, LOCK, STOCK AND BRANDY, TO THE PREMISES ON THE HIGH STREET

*N.B.*

*IF YOU CAN'T FIND US,  
LOOK FOR THE TANDY SIGN  
WE ARE NEXT DOOR!*

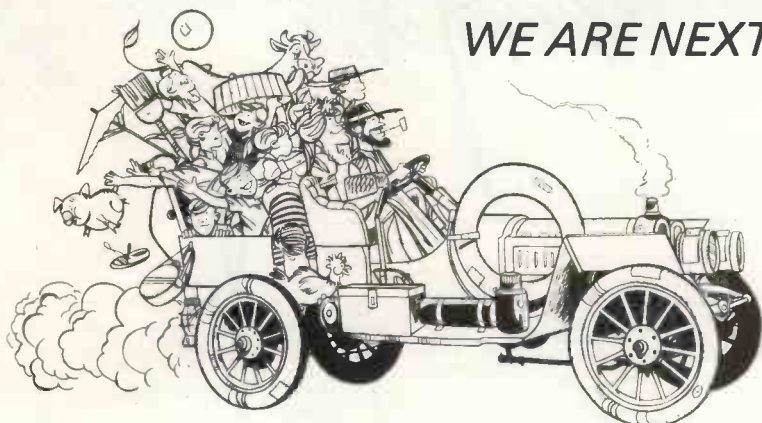

## ROSTRONICS LTD.

The TRS-80 Specialists  
115-117 Wandsworth High St.,  
London SW18  
Telephone: 01-870 4805  
Telex: 8813089 INTPRMG.

• Circle No. 193

## The Rohan Computing Collection.....

Rohan computing, in addition to their normal software and systems consultancy services, now offer the following range of computer equipment for sale. As far as possible Rohan computing try to hold these items in stock ready for immediate delivery. Nationwide on site maintenance for all Rohan computing equipment.

**Qume** The Qume is ideal as a general purpose printer or for adding word processing facilities to an existing micro-computer. Print only and keyboard versions available. The keyboard version can double as a spare typewriter, RS232 interface adaptable for the PET, APPLE, etc. XON/XOFF protocol available. Word processing package/driver available for CP/M based systems. Other versions in preparation.

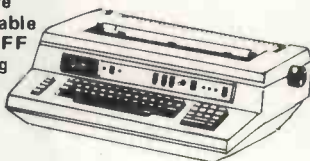

**Digital Decwriter IV.** The best desk top matrix printing terminal available. Typewriter styling. 10,12,13,2,16.5 characters per inch. All sizes very legible. 2,3,4,6,8,12 lines per inch. Optional tractor feed and numeric keypad. RS 232 interface.



**PET** Commodore PET microcomputers. The PET is the ideal low cost computer for teaching yourself programming, educational use and time consuming calculations in science, industry and commerce. Graphic display excellent for histograms etc.  
\*8k PET with integral cassette and minikeyboard  
\*16 & 32k PET's with full sized professional keyboards.  
\*2022 matrix printers  
\*2040 floppy disc units.



**CIFER** Cifer 2600 Series VDU's. Superbly engineered and made in Britain. \*12 inch screen.  
\*7 x 11 character matrix  
\*9 x 12 matrix for graphic characters  
\*62 or 100 key detachable keyboards  
\*Printer port  
\*VT52 emulation  
\*Line drawing set

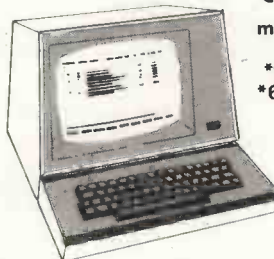

\*RAIR Blackbox, Teletype 43s, Tally high speed matrix printers also available.\*

# Rohan

Phone Richard on SOUTHAM (092681) 3541 for prices and delivery.

Rohan Computing, B.A.S.S. (Engineers) Sales Limited, Kineton Road, Southam, Warwickshire CV33 0DQ

• Circle No. 194



# Arithmetic without need for number-cruncher

IF YOU have attempted an analysis of variance or tried to calculate a co-efficient of regression, you will have become painfully aware that statistical analysis involves a good deal of squaring and summing of many numbers which have an excessive quantity of significant figures.

Beware of trying to simplify the task by reducing the number of significant figures, for, at the end of calculation, you may be required to subtract one large number from another slightly greater number and base your conclusions on the relatively minute difference between them.

If you have already discarded too many significant figures, you may find that you have a negative difference, which is meaningless. Even if the difference is positive it could still be seriously in error.

In the days before electronic calculators, the task of working-out an analysis on paper was one of the most tedious operations imaginable. The coming of the calculator, especially the dedicated statistical calculator with built-in programs, has made a vast difference to the lives of those who have need from time to time to wrestle with statistics.

Now follows the microprocessor but alas, in spite of all its advantages, it is not designed to handle the large arrays of figures and perform the relatively-complex calculations traditional methods of analysis require. Coupling it to a number-cruncher is asking the microprocessor to do your job at the calculator keyboard and is not really taking advantage of the special features of the microprocessor.

## Distribution

The mention of traditional methods of analysis is a reference to those tests such as the t-test, the analysis of variance and the chi-square test, which depend on the assumption that the data being analysed is distributed according to a known and clearly-defined pattern.

It is assumed that items of data are likely to be clustered around their mean value in some particular way. Many tests assume that the data is normally distributed. What is meant by the normal distribution needs some fairly complex mathematics to describe it, for the point is that if analysis relies on data being so distributed when the data is not so distributed, our analysis will be faulty. We may arrive at the wrong conclusion.

If we have a large amount of data, it may be possible to find its distribution pattern but if, as usually happens, the amount of data is small, there is no way of

knowing how it is distributed.

Distribution-free tests — or non-parametric tests — do not rely on assumptions about distribution. They are easy to understand, they work just as well when the amount of data is small, and they do not require long calculations with innumerable significant figures.

Even a microprocessor can cope with the arithmetic required, without assistance from a number-cruncher. These tests may require somewhat tedious and lengthy manipulation of the data — sorting, ranking, re-arranging rows or columns of tables — but this is all to be done according to simple logical rules. The conclusion is that the microprocessor

number of runs (= u). For our example, u = 6:

```
111 000 111111 000 1 000
  1   2   3   4 5 6
```

If people are tending to copy their neighbours, the number of runs will be fewer than would be expected by chance. What number can we expect by chance? We can calculate the probability of occurrence of different numbers of runs from the minimum (u=2) to the maximum (u=20), using the methods of calculating combinations and permutations you learned at school, and set out the results in a Table of Critical Values.

Such a table tells us that with 20 events, as in our example, the probability of a

**AT FIRST SIGHT microcomputers seem made for number-crunching. As Owen Bishop points out, however, this is not necessarily so and special measures may be necessary. Bishop is a biologist and author of *Statistics for Biologists*.**

and the distribution-free test were made for each other.

As an example of a distribution-free test, some can be used for analysing problems not covered by the parametric tests. The Runs Test has several other applications. For example, a simple modification gives a way of comparing the means of two sets of data — an equivalent of the t-test. We can also use the Runs Test for investigating trends.

The Runs Test is concerned with a sequence of events. They may be events in time — a list of the days of the month, marked to show on which days a given piece of factory machinery broke down. Or they may be a series of events in space — the brand of TV set used in each of the houses along a street.

## Street survey

If '1' represents a house with a TV set made by manufacturer A, an '0' represents a house with a set made by other manufacturers, a survey of the street of 20 houses might be recorded like this:

```
1110001111110001000
```

Now, we could ask, if the brand A owners are clustered together more than we might expect if the people had chosen a brand at random? The long run of brand A owners in the middle of the street could mean that people tend to buy their set on the recommendation of their next-door neighbours. If that is true, it could have marketing implications. But is it true?

To analyse the data we assess the degree of clustering by counting the

sequence with six runs or fewer is only one in 20. The chance of more than six runs is 19 in 20. Given this we can say:

*either* 'this street is the odd one in 20 which has as few as six runs; it tells us nothing about how people choose TV sets;  
*or* 'it is unusual to find as few as six runs; there are 19 chances in 20 that people are copying their neighbours; this is an important fact for the next sales promotion.'

Most people would be happier to act on the second statement, while accepting the one in 20 risk that the first statement was correct.

The essence of the Runs Test is to arrange the data in sequence, count the runs, and compare the number to the critical value (U) looked-up in the table. The table has three sets of critical values for each of the probability levels 1 in 20 (p=0.05), 1 in 100 (p=0.01) and 1 in 1000 (p=0.001) so we need to look at each set in turn.

## Comparisons

The data is entered in memory as a series of 0s and 1s; the total number of events—e.g. houses—is entered after the last item of data. The program reads the first datum and the second. If the second is not 0 or 1, it must be the total number of events (2n), meaning that the data has all been examined and the program must move on to display the result.

During the operation of the program, each item of data is compared to the item following it, to see whether or not they are equal. If they are equal the run continues;

(continued on next page)

(continued from previous page)

if they are unequal, a new run is recorded. When all data has been examined, the number of runs and the total number of events is in memory. Next  $2n$  is halved to give  $n$ , used in locating the appropriate line in the table of critical values.

The program looks up  $U$  for the given value of  $n$  and for  $p=0.001$ . If  $u$  is less than or equal to  $U$ ,  $P=0.001$ , and the program builds up this information in the display stores and displays ' $p \leq 0.001$ '. If  $u$  is greater than  $U$ , the program looks at the next section of the table, to find  $U$  when  $p=0.01$ .

If  $u \leq U$  at this stage the display reads ' $p=0.001$ ', but if  $u > U$ , the program looks finally at the third section of the table for which  $p \leq 0.05$ . Even at this stage  $u$  may be greater than  $U$ , indicating that the number of runs is so large as to be unremarkable, and the display then shows ' $p > 0.05$ ', a result which is generally of no interest. These are not the kind of odds on which we would wish to base a major marketing scheme.

### Adaptable

The program is given in machine code for the MK-14, to prove that even a small system can handle useful statistical tests. The program is explained in some detail, so that readers can adapt it for other systems. The main program runs in basic RAM, leaving room for some small additions to adapt the test for other applications.

The table of critical values and the table of data are entered in extra RAM. There is room for entering far more than the 40 items of data for which the program is designed. Those users who handle longer series of data frequently can calculate and enter an extended critical values to cater for their requirements.

### RUNS TEST

Performs Runs Test on a maximum of 40 values, 0 or 1, entered from OB00, and displays significance level. Main program relocatable; tables relocatable by changing pointers.

0000 = OFID

OFID  $u$ , counts number of runs

OFIE  $d_1$ , first datum of a pair

OFIF  $d_2$ , next datum after  $d_1$

OF6F - OFD4 stores for display characters

OB00 table of data

OB80 table of critical values of  $U$

$2n$  = number of values entered and is stored at end of data table

OF20 C40B LDI OB

OF22 35 XPAH P1

OF23 C400 LDI 00

OF25 31 XPAL P1

Points P1 to table of data (OB00)

OF26 C40B LDI OB

OF28 36 XPAH P2

OF29 C480 LDI 80

OF2B 32 XPAL P2

Points P2 to table of critical values (OB80)

OF2C C401 LDI 01

OF2E C8EE ST

Sets OFID to 1, ready for counting

OF30 C501 A:LD @ P1 + 1

Loads  $d_1$ , first datum

OF32 C8EB ST at OFIE

OF34 C501 A:LD @ P1 + 1

Loads  $d_2$ , next datum

OF36 C8E8 ST at OFIF

OF38 1C SR gives 00 only if  $d_2$

is 00 or 01: tests for end of data list

OF39 9C13 JNZ to C

OF3B C0E3 LD  $d_2$  from OFIF

OF3D E0E0 XOR with  $d_1$  from OFIE; gives 0 if  $d_1 = d_2$

OF3F 9807 JZ to B end of run not reached yet

OF41 C401 LDI 01

OF43 02 CCL

OF44 E8D8 DAD  $u + 1$

OF46 C8D6 ST at OFID

Increments runs counter as run ends

OF48 C0D6 B:LD  $d_2$  from OFIF

OF4A C8D3 ST  $d_2$  to OFIE

OF4C 90E6 JMP to A, to collect next datum and put in OFIF

OF4E C0D0 C:LD  $2n$ , from OFIF

OF50 1C SR  $2n/2 = n$ , discarding any  $\frac{1}{2}$

OF51 01 XAE  $n$  in extension register

OF52 C280 LD P2, displacement =  $n$ ; value of  $U$  for  $p = 0.001$

OF54 03 SCL }  $U \cdot u$

OF55 F8C7 CAD }  $U \cdot u$

OF57 941A JP if  $u \leq U$ , significant for  $p = 0.001$ ; to D

OF59 C411 LDI X'11 (= 17<sub>10</sub>)

OF5B 02 CCL

OF5C 70 ADE  $n + 17$

OF5D 01 XAE  $n + 17$  in extension register

OF5E C280 LD P2, displacement =  $n + 17$ ; locates value for  $U$  for  $p=0.01$

OF60 03 SCL }  $U \cdot u$

OF61 F8BB CAD }  $U \cdot u$

OF63 9418 JP if  $u \leq U$ , significant for

$p = 0.01$ ; to E

OF65 C411 LDI X'11 (= 17<sub>10</sub>)

OF67 02 CCL

OF68 70 ADE  $n + 34$

OF69 01 XAE  $n + 34$  in extension register

OF6A C280 LD P2, displacement =  $n + 34$ ; locates value for  $U$  for  $p=0.05$

OF6C 03 SCL }  $U \cdot u$

OF6D F8AF CAD }  $U \cdot u$

OF6F 9412 JP if  $u \leq U$ , significant for  $p=0.05$ ; to F

OF71 901E JMP not significant at  $p=0.05$ ; to I

OF73 C406 D:LDI 06 (character, 1)

OF75 C859 ST store 1 (OF6F)

OF77 C43F LDI 3F (character, 0)

OF79 C856 ST store 2 (OFD0)

$p=0.001$ , stores characters for two right-hand digits

OF7B 900E JMP to H

OF7D C406 E:LDI 06 (character, 1)

OF7F C850 ST store 2  $p=0.01$

OF81 9004 JMP to G

$p=0.01$ , stores right-hand digit

OF83 C46D F:LDI 6D (character, 5)

OF85 C84A ST store 2

$p=0.05$ , stores right-hand digit

OF87 C400 G:LDI 00 (blank)

OF89 C845 ST store 1

$p=0.01$  or  $0.05$ , stores blank to right

OF8B C469 H:LDI 69 (character,  $\leq$ )

OF8D C845 ST store 5

$p=0.001$ ,  $0.01$  or  $0.05$ , stores  $\leq$

OF8F 9008 JMP to J

OF91 C46D I:LDI 6D (character 5)

OF93 C83C ST store 2

OF95 C44A LD 4A (character  $>$ )

OF97 C83B ST store 5

not significant, stores  $> \& 5$ , with two blanks between

OF99 C43F J:LDI 3F (character, 0)

OF9B C835 ST store 3

OF9D C4BF LDI BF (character, 0)

OF9F C832 ST store 4

OFA1 C473 LDI 73 (character, P)

OFA3 C830 ST store 6

For all results, stores P, space, 0, 0

OFA5 C40D K:LDI 0D

OFA7 35 XPAH P1

OFA8 C400 LDI 00

OFAA 31 XPAL P1

Points P1 to display (0D00)

OFAB C40F LDI 0F

OFAD 36 XPAH P2

OFAE C4CF LDI CF

OFB0 32 XPAL P2

Points P2 to stored characters

OFB1 C200 LD P1 + 0

```

0FB3 C901 ST P2 + 1
0FB5 C201 LD P1 + 1
0FB7 C902 ST P2 + 2
0FB9 C202 LD P1 + 2
0FBB C903 ST P2 + 3
0FBD C203 LD P1 + 3
0FBF C904 ST P2 + 4
0FC1 C204 LD P1 + 4
0FC3 C905 ST P2 + 5
0FC5 C205 LD P1 + 5
0FC7 C906 ST P2 + 6
0FC9 C206 LD P1 + 6
0FCB C907 ST P2 + 7
0FCD 90D6 JMP to K
    
```

Displays characters in stores 1 to 6 in display at digits 1 to 6  
END OF MAIN PROGRAM

## RUNS TEST - TABLE OF CRITICAL VALUES OF U

Based on Table 84 from BISHOP, O. N. (1971), STATISTICS FOR BIOLOGY (Longman, London, 2nd edn.) Relocatable, if P2 pointed to start address by altering 0F27 and 0F2A altered in main program

```

0000 = 0B8Q
0B80 00 00 00 00 00 00 02
0B88 02 03 04 04 05 05 06 07
0B90 08 08 09 0A 0B 00 02 02
0B98 03 04 04 05 06 07 07 08
0BA0 09 0A 0A 0B 0C 0D 02 03
0BA8 03 04 05 06 06 07 08 09
0BB0 0A 0B 0B 0C 0D 0E 0F
    OBB6 = END
    
```

## RUNS TEST - TYPICAL DATA TABLE

Enter 00 to represent one category of event, 01 to represent the other. Enter events serially in order of occurrence. When all events entered enter the lower byte of the next address in the next address (gives total number of events) Relocatable, if P1 pointed to start address by altering 0F21 and 0F24 in main program

```

0000 = 0B00
0B00 00 00 00 01 01 01 01 01
0B08 00 00 00 00 00 00 01 01
0B10 01 01 00 01 01 01 00 00
0B18 00 00 01 01 01 01 1E
    OB1E = END
    
```

The typical sequence above represents data with 30 events:  
000111110000001111011100001111

Number of runs = 8; n = 15  
(14 0's, 16 1's); significant for  $p < 0.01$

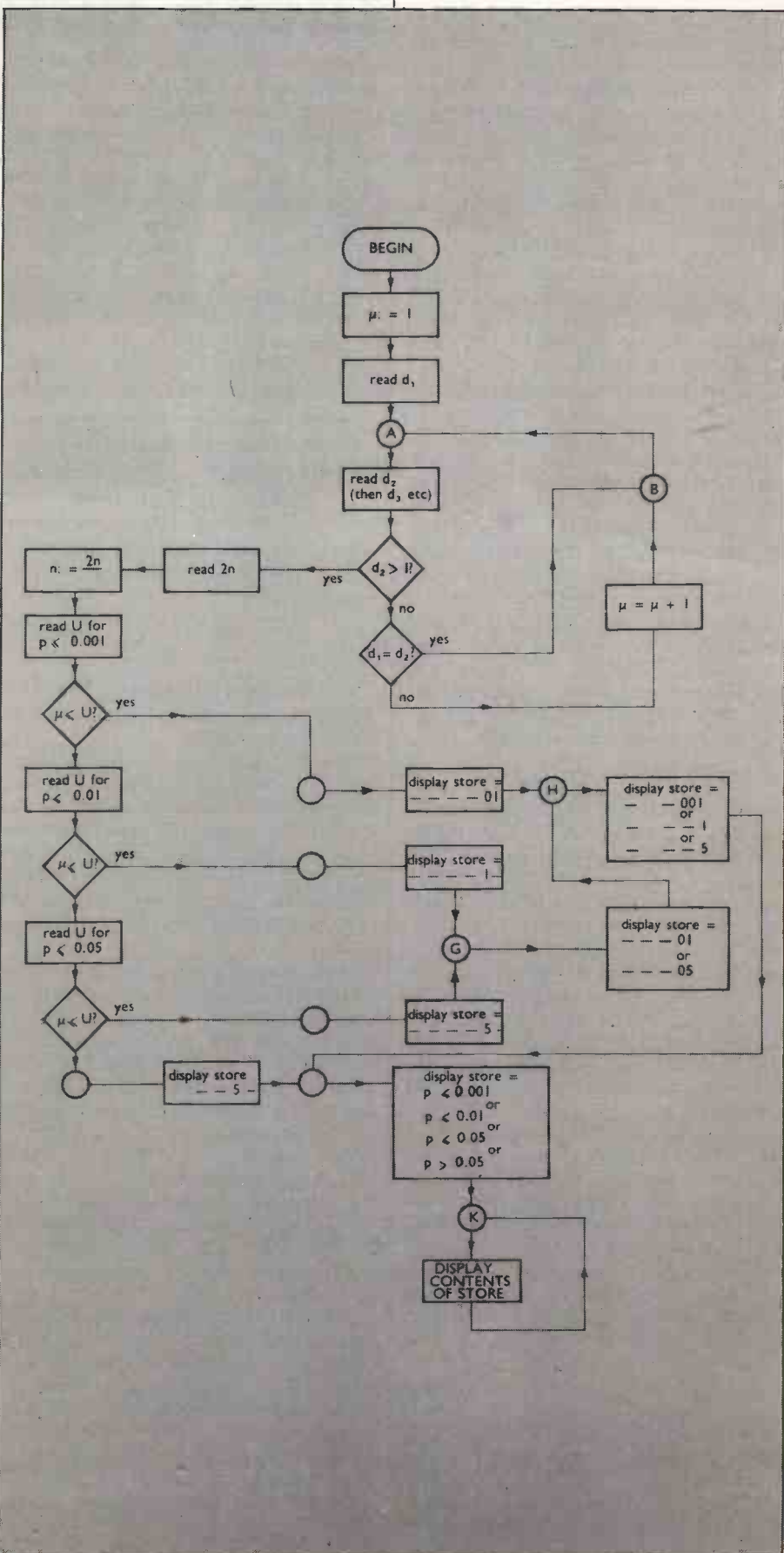

ARE YOU to scared to PEEK? Does the thought of POKE frighten you? Does USER leave you white and trembling? If so, welcome to the club. Potentially, POKE and USER are the most deadly of Basic commands, since a single-digit error can not only bomb your program but the Basic interpreter as well.

So you are a cautious type and you have taped a copy of your program carefully before entering POKE or USER, so not for you is the appalling chore of entering it by hand all over again, but you still have to re-load your Basic and then re-load the program.

You are facing anything up to an hour of hanging around waiting while Basic and your program are loaded. No, PEEK, POKE and USER are not funny. Even one experience of that kind is too much for many of us.

Disc is not so bad, of course, but it is Murphy's Law that if a program is to bomb, it will do so just at the end of a long evening session of program development, before the most up-to-date version has been saved on disc.

It is no wonder that PEEK and POKE are left severely alone. Yet, treated kindly, we can do many things with them which are not possible in any other way. For example, few Basics have a command giving control over an external device such as a relay, thyristor or uni-selector, despite the fact that many computers will have been bought for the express purpose of environmental control.

### Superb for learning

As another example, some simpler versions of Basic do not provide for user-defined functions — the DEF and the FN(X) of better versions. PEEK, POKE and USER provide that facility. Taking an overall view, we can say that Basic is superb for learning programming; easy to write; expensive in its use of memory; slow in execution; strictly limited in its application. On the other hand, machine code is tedious to write; easy to bomb; parsimonious in its memory use; the ultimate in speed of execution; and infinitely variable in application.

The good thing about PEEK, POKE and USER is that we are able to have the best of both worlds. We avoid the tedium of writing huge chunks of machine code but when we need the speed and flexibility of machine code, PEEK, POKE and USER provide it.

Before you can steer the beast you must be able to ride it and that means that we must be fully conversant with machine code.

Assuming that you know something about machine code, how do we use PEEK N' POKE? Let us take a very simple example. Users of the SWTP and others may have a cassette interface giving automatic control of the cassette motor. The AC-30 is one such example. It contains a miniature relay which is

# How to avoid those bombs

switched-in on receipt of a READ ON signal from the control interface, or on receipt of a RECORD ON signal.

In machine code, that is executed very simply by loading the A register with the hex value 11 (READ ON) and branching to a subroutine which sends the appropriate signal (OUTEE). In Basic, however, the only commands which send the appropriate signal are SAVE, LOAD and APPEND, none of which is of much use if you are doing something else with that outgoing signal.

Enter PEEK N' POKE. The job breaks-down into several easy stages. First, we

by Derrick R Daines  
Deputy Head, Carsic School,  
Sutton in Ashfield

write a subroutine in machine code which does what we want. In the example given, we would write:

```
86 11 LDA A Load A with READER ON command
BD EL DI JSR Output contents of A register
39 RTS Return form subroutine.
```

The example is for the 6800 micro. That RTS command is absolutely vital and we forget it at our peril.

The next problem concerns the questions of where to put our subroutine. Examination of Basic by means of the PATCH command will show that when Basic is first entered, all contiguous memory from the end of Basic to the top of memory is cleared (00) and that the topmost 256 bytes are reserved for string buffer.

Most Basics clear memory by first entering 00 and then checking to see if the memory addressed contains 00. It continues in that way until it encounters an address which does not respond — no memory there — and then backing-off 256 bytes. The address is then stored as the end-of-memory.

The clearance of memory by Basic renders it impossible for us to load machine code anywhere in memory contiguous with that occupied by Basic, either by hand, from tape or from disc, without it being wiped-out the instant that we enter Basic.

There are three possibilities; we can re-address one memory board to cause a break in the continuity of memory. That will fool the interpreter into 'thinking' that it has reached the end of memory when it has not; we can fool the interpreter about the beginning of available memory; we can find some small amount of memory to spare elsewhere in the system.

The first solution is satisfactory if we

expect to use a very large machine code program and is the solution which allows a disc operating system to be co-resident with Basic, but it would be scarcely sensible to allocate 4K of memory for one small subroutine. Those things have to be balanced.

The second solution brings in its wake a complication of finding and altering the memory Basic uses for the retention of the next available address. It is possible and for medium-sized subroutines may be the only solution.

For a tiny subroutine such as the example, the third solution is the best and it is surprising how many bits of unused memory can be found lying around if you search. Users of MIKBUG and SWTBUG will be familiar with the spare RAM at locations A014-A033 and A04A-A07F, for example, and no doubt other systems have unconsidered trifles waiting to be used. They are ideal for our purpose. They are not contiguous with core and so will not be wiped clear by Basic. They offer a small insurance against bombing, for the same reason, and the alteration of Basic mentioned is not required.

### Double check

So we have our machine code program and a location to hold it and the next problem is how to get it in there. Of course, we could enter it by hand if we were not scared and not bothered about the delay, but we will not learn anything, so let us forget it.

Loading from tape or disc might be the best solution if the machine code program is a large one or has been CHAINED, but for small routines it is doubtful if it is worth the extra effort involved. We will still to need POKE commands anyway and the method is simple.

The other possibility is for Basic to enter our machine-code program and obviously POKE is the command with which to do it. The general format is very simple:

```
FOR X 1 TO (number of bytes)
READ Y
POKE ((base address less 1) plus X,Y)
NEXT X
DATA (machine code program)
```

The POKE statement takes the value of Y and places it in the location indicated by the expression before it. Note very carefully that the values and addresses are IN DECIMAL, so we must alter our machine code program and the first assigned into decimal:

```
(40980) A014 86 11 LDA A (134 17)
A016 BD EI DI JSR (189 225 209)
A019 39 RTS (57)
```

Substitute in the BASIC format given:

```

10 FOR X 1 to 6
20 READ Y
30 POKE (40979 X,Y)
40 NEXT X
50 DATA 134, 17, 189, 225, 209, 57
    
```

Notice that in line 30 the base address is decremented by 1 because on the first pass through the loop X will have the value 1.

Double-check everything, particularly the conversion from hex to decimal, and type-in the five Basic commands, taking particular care with the DATA line. Now type RUN and then use the PATCH command to check that the desired machine code program has gone where you expected it to do. If it has not, you have some detective work and double-checking to do.

If everything is satisfactory then before we can jump into the USER command there is one other thing we must do — we must tell Basic where to find our little program. When Basic is first loaded, whenever it encounters a USER statement, it jumps to an address which points to a location containing the value 39.

That obviously is a very necessary insurance, since it returns the program immediately back to Basic, but we must then change the first address and make it point to the start of our program. The address should be listed in the documentation accompanying your Basic and in my case is 0067 — 0688.

Changing those into decimal gives 103 and 104, addresses into which I wish to POKE. Before doing so, however, it would be wise, if not vital, to PEEK into them and make a note of their contents.

The values I wish to POKE make-up the starting address of my program — A014. That must be split into two bytes A0 and 14 before their conversion into decimal, which gives 160 and 20.

## Reward

Now we may write our final two POKE statements:

```

60 POKE (103,160)
70 POKE (104,20)
    
```

Again using RUN and PATCH, we can check that the necessary alterations have been made. If all is well we take a deep breath, add a USER command and RUN. If the method has been followed faithfully, we will be rewarded by the switching-on of the tape recorder motor, followed by a return to Basic.

By itself, the achievement is not very great unless we have been too timid to try POKE and USER before but it becomes exciting when we consider the potential. With that single little routine we have opened a door on a whole new world of computer-controlled environment.

The December, 1978 issue of *Kilobaud*, for example, contained a Spelling Bee program in which the cassette recorder was used to record the sound of the human voice. The method of preparing the Spelling Bee involves a fixed-time loop which runs the cassette for a few seconds.

In that time the user speaks the word, thus recording it. The program asks for the correct spelling of the word and then goes again into the time loop. The process continues until 40 words have been put in, or the user types STOP. The program then loops to a test portion in which another user, a pupil, hears the word being spoken and is scored on his correct response to the request for the spelling.

It is, of course, very similar to the dedicated Speak and Spell, but with the advantage of an infinite variety of words without a mid-Atlantic accent. Unfortunately, the variety of Basic in which the program is written does not seem to be very common here, but our sample program is extended easily:

```

A014 86 12 LDA A Recorder on (134 18)
A016 BD E1 DI JSR (189 225 209)
A019 5F CLR B (95)
A01A CE 00 00 LDX Loop 1 (206 00 00)
A01D 08 INX Loop 2 (8)
A01E 8C FF FF CPX Loop 2 (140 255 255)
A021 26 FA BNE (8 250)
A023 5C INC B (92)
A024 C1 07 CMP B (193 7)
A026 23 F2 BLS Loop 1 (35 242)
A028 86 14 LDA A Recorder off (134 20)
A02A BD E1 DI JSR (189 225 209)
A02D 39 RTS (57)
    
```

The subroutine switches-on the recorder for five seconds and then switches it off again, the timing adjustment being made by altering the 07 if so desired. In Basic the routine becomes:

```

10 FOR X 1 TO 26
20 READ Y
30 POKE (40979 X, Y)
40 NEXT X
50 DATA 134,18,189,225,209,95,206,0,0,8,140,255,
255,38,250,92,193,7,35,242,134,20,189,
225,209,57
60 POKE (103,160)
70 POKE (104,20)
    
```

For copyright reasons I am reluctant to give more details, except to say that the USER statement should form the major part of a subroutine accessed both by recording half of the program and the playback half. Screened instructions are also required for the pupil to wind back the cassette to the beginning in manual mode before switching to auto.

Obviously, synchronisation of sound and program string matching is achieved by time of record and playback. The tape must therefore start at the spot and the best place is at the beginning of the tape.

There is a time, of course, when one of two things will happen. Either the DATA statements become inordinately long, or we run out of handy little locations in which to POKE our routine. When that happens we have to start tinkering a little more with the Basic interpreter.

The best plan is to place the machine code routine in memory immediately following the Basic interpreter. Basic uses an address to hold in memory the location of the next available address. It is updated constantly as new statements are added or others deleted.

When Basic is first loaded, this address points to a location immediately following the Basic interpreter. The documentation

accompanying your Basic will have details. In my case, this address is at 014E-014F, initially being set to 1EAF (SWTP Basic, Version 2.0).

Suppose, therefore, that I load a machine code program from 1EAF to 2048, I must alter locations 014E-014F before typing G for G0, thus entering basic, which would wipe-out the machine code. It follows that this alteration should be an integral part of my machine code recording, together with the USER pointer mentioned earlier.

It may be worth remembering, however, that when we have finished with the Basic program which called the USER subroutine, we have no more use for that subroutine, yet Basic will not over-write it unless and until we change the pointer to next available memory.

That might be embarrassing if memory space is tight in a later program. To overcome that it would be wise to make a note of the original address pointed to and also to add two POKE statements at the end of the parent Basic program which would restore this pointer:

```

9000 .....
9010 PRINT "ANOTHER GAME";
9020 INPUT Q$;
9030 IF Q$ "YES" THEN 750
9040 PRINT "GOODBYE"
9050 POKE (334,30)
9060 POKE (335,175)
9070 END
    
```

We have not discussed the possibility of passing information between Basic and the machine code subroutine in either direction but it should be tolerably obvious that PEEK and POKE is one way of doing it. My version of Basic supports a USER statement of the form.

LET X USER (Y)

in which either or both of X and Y may be utilised to transfer information. I also have a 3K Basic without this facility which forces the use of PEEK.

## Complicated

Perhaps the simplest illustration would be where a subroutine raises a flag when something is done — or a test completed successfully perhaps and clears it when not. In that case we must reserve memory bytes as integral parts of our machine code routine, adjust or clear them during the subroutine, and then on return to Basic to execute a conditional test using the PEEK command.

If we do not have the facility to compute a desired transcendental as a user-defined command — DEF and FN(X) — and let us suppose we require the Arc-tangent of a number. Obviously things become a little complicated but the same system is followed. We write a machine code program which computes the desired transcendental and stores it to the desired degree of accuracy in a series of reserved memory bytes.

We can point out that PEEK tests would need to take into account the position of the decimal point and the possibility of calculation overflow. 



# Gentlemen, the Petdisk has landed . . . **£499** (single disk)

The U.K.-designed and manufactured Novapac disk system for Commodore's PET\*, first seen at Compec '78, is (after extensive industrial evaluation), now available to the domestic user. Its unique saddle configuration continues the integrated design concept of your PET, with no trailing wires or bulky desk-top modules.

- \* Novapac may be used with any available RAM plane.
- \* May be used with latest versions of PET.
- \* Data transfer takes place at 15,000 char/sec - effectively 1,000 times faster than cassette!
- \* Storage capacity is 125 K/bytes (unformatted) on 40 tracks per diskette side.
- \* Dual index sensors permit dual-side recording for 250 K/bytes per diskette.
- \* Easy operation full-width doors prevent media damage.
- \* System expandable to 3 Mbyte on-line storage (4 drives).
- \* Dual head and 2D versions provide 2 Mbytes on-line.
- \* Industry Standard IBM 3740 recording format for industry-wide media compatibility offered only by NOVAPAC.
- \* Dedicated Intel 8048 microprocessor and 1771 FDC minimise PET software overhead.
- \* Local hardware and software support available, including applications packages for small business use.

The sophisticated Disk Operating System is disk-resident, which allows for future DOS-enhancements without hardware alterations. PDOS supports multiple file handling, allocating disk space dynamically to each as and when necessary. Any file may occupy from 1 to 600 sectors as required, at up to 16 non-contiguous locations on the disk, PDOS may be used alone, or within a BASIC program and offers user-specified password security for any file. Multiple access-modes simplify BASIC program construction, and the user may generate tailored DOS modules. **Novapac dual-disk system** complete with PDOS and BASIC demonstration programs on disc **£899 + VAT**.

Available from the manufacturer or selected dealers.  
Terms: 50% with order, balance on delivery.  
Full cash with order is subject to 5% discount.  
VAT-FREE Export arranged (Must be shipped by us).

**analog electronics**

47 Ridgeway Ave,  
Coventry  
Tel: (0203) 417761

• Circle No. 195

## COMPUTER FIELD MAINTENANCE

*Keeps SWTP running smoothly*  
*Keeps Cromemco running smoothly*  
*Keeps Sol running smoothly*  
*Keeps Horizon running smoothly*  
*Keeps Abacus running smoothly*  
*Keeping things running smoothly*



# CFM

**Computer Field Maintenance**

*A CWT company, a Member of the IAL Group.*

Excell House, Trust Industrial Estate, Wilbury Way  
Hitchin, Herts SG4 0UZ

Tel: (0462) 51511 Telex: 826649

• Circle No. 196

## The C Programming Language

By Brian W. Kernighan and Dennis M. Ritchie; published by Prentice-Hall International, 1978; distributed in the U.K. by Prentice-Hall International, paperback, 228 pages; price, £8.

READ this book to learn how to format attractive telephone directories. It describes a high-level programming language developed by Bell Telephone Laboratories, mainly for use on PDP-11s, for applications such as string processing.

The C language developed partly from ideas in a language called B, which also gave rise to the academically-favoured BCPL. Ritchie's C contains many neat little features to allow users to produce tight, recursive, probably incomprehensible code. There are IF-ELSEs, ELSE-IFs, DO-WHILEs, a "rich set of operators" including pre- and post-increment and decrement. There are variable-length bit fields, user-definable datatypes, variable datatype UNIONS, array pointers, arrays of pointers, multi-datatype data structures.

This cornucopia of features can be used for esoteric string processing and record manipulation as part of "a wide range of applications". The authors describe the features in a clear and readable manner, and the readability probably is improved by being typeset by the authors with a PDP-11 programmed in C using the UNIX operating system.

### Limited

The value of reading the book, however, is likely to be limited for the British reader unless he has access to a machine running the UNIX operating system. UNIX was developed to support the C language — it is written largely in C, illustrating again the range of the language application — and although C compilers, mainly written, naturally, in C, have been developed for IBM 370, Honeywell 6000, and Interdata 8/32, UNIX on the PDP-11 remains the main support for C programmers.

UNIX runs only on PDP-11s; it is licensed only for a very large fee by Bell Labs, except for academic use. For universities it is inexpensive and the fact that the operating system is written in C makes it attractive as a teaching tool for university computer departments.

A certain number of commercial users have adopted UNIX in the U.S., presumably for the advantages it has offered in the past for PDP-11 users seeking to escape from assembly language or Fortran programming. As other new "structured" languages such as Pascal, Coral-66, and the forthcoming ADA have become



available for PDP-11s and the newer Digital Equipment VAX-11, it is no longer clear that C provides such exceptional advantages.

The language has some potential disadvantages too. There are dialect differences between newer and older compilers. The "rich set of operators" with asterisks and double plus signs, combined with the inherent dangers of over-kill in the use of recursive code, can produce very slick but incomprehensible programs; this is likely to appeal to programming enthusiasts but not to programming managers.

A future for the C language and this excellently-produced language text-book might lie in the personal computer market, where programming enthusiasm and high-level facilities are valuable. The high licence fees charged for the PDP-11 UNIX system would not, however, be available. Even though the authors claim that a new C compiler can be developed in two months for most machines, there may not be the effort forthcoming to continue the C language on to new machines in the 1980s.

### Conclusions

- The C Programming Language is a well-produced book describing a powerful and interesting language it is probably of more esoteric interest than other literature describing recently-developed programming languages such as Pascal.

- Its background as a one-off language produced and marketed by Bell Laboratories for the Digital PDP-11 probably limits continued development of the C language.

### How to profit from your personal computer

By T.G. Lewis; published by Hayden, 1978; distributed in the U.K. by Butterworth; paperback, 192 pages; price, £4.80.

THE BEAUTY of the new computing is that it means many things to many people. If computers are cheap and if computing is easy, the anti-establishment adherent can see in it a return to small-scale values which threatens and ultimately will replace the centralised, controlled facilities for

information and calculation which characterise the present way of doing things.

The technological democrat sees cheap computing as a way of automating all the trivial and repetitive aspects of life, taking the dross from existence and allowing us to exploit our potential more fully.

Then there are the pragmatists, the entrepreneurs, who see in small computers the opportunity for many of us to set-up small businesses to do smallish jobs for other small business.

If you want some illumination on the social possibilities, a good place to start is a group of three recent articles in the radical technology magazine *Undercurrents* issues 27, 30 and 32 — highly recommended.

If you are a capitalist at heart, you may well reach for Theodore Gyles Lewis. Like most writers in the field, Ted Lewis is American and a college lecturer (Oregon State).

His 'preface' opens with a curious disclaimer. "My goal in writing this material was to convey the important features of personal computers useful to computer aficionados".

In fact, he has written the kind of introduction to small computers which computer aficionados will probably find too light. It is for novices in particular — people who might be thinking about a personal computer.

### Too specific

The book describes the uses of personal computers in common business applications, such as accounting, handling payrolls, managing inventory, and sorting mailing lists. Many Basic language programs are reproduced to illustrate the techniques discussed by the author. Some of them will be too specific to the U.S. for direct use here but the general principles seem sound and, at this fairly elementary level, the programming techniques look good.

The style in which the book is written is more debatable. It is described as "entertaining". It is somewhat less than that. The organisation of the material is confusing, combining definitions, programs, and story-telling in a disorientating jumble. The frequent attempts at humorous paragraph headings are often misleading.

Nonetheless, once you adjust to the idiosyncrasies, the content is generally worthwhile and occasionally stimulating. Of the 10 chapters, five are devoted to detailed case histories of personal computing applications. The variety of techniques used in those applications will give the reader a good foundation for programming most applications occurring in business or in the home.

The case histories include mort-

gage repayments to a savings and loan company — like building societies; mailing lists; accounts receivable — for a doctor's office; a household budget system and a real estate — estate agents to us — package.

Each has a listed Basic program which the reader can try to use. More likely you will utilise it as a basis for a more or less sophisticated system.

The preceding four chapters, in a roundabout manner, attempt to define personal computer terminology. The last chapter is T. Lewis' look at the future. It is an interesting overview of a world where the microcomputer is ubiquitous with much talk of the 'global village' (Lewis ignores any political and cultural considerations which will spoil his future fun).

The electronic office, the computer-controlled house, the massive, computerised communications network — all there, and according to Lewis, they will all be linked with personal computers on a scale comparable to the current blanketing typified by transistorised radios and calculators. Well it might happen.

### Conclusions

- Lewis has the word Profit exhibited boldly in his title. His case histories, particularly the inventory control system and doctor billing system, demonstrate the way personal computers can be employed profitably today.

- His premise — "only lack of knowledge and lack of awareness of the usefulness of computers are barriers to anyone wanting a personal computer" — is too broad, but for a narrower argument — like "don't be afraid of computers, here's why" — this book moves neatly to the rescue.

### Be a Computer Literate

By Marion J. Ball and Sylvia Chapp; published in 1977 by Creative Computing Press; paperback, 61 pages; price, £3.00.

THE LADYBIRD book on computers for children has a well-deserved reputation as a good low-level introduction and there are apocryphal stories of large organisations scouring children's bookshops to buy it in bulk for senior executives.

*Be a Computer Literate* is better. It's more up-to-date, more fun, and its pedigree gives it more class — *Creative Computing* is one of the best U.S. magazines.

This book has been beautifully written and very well-presented. It is very easy to read, with large print — and charming drawings; and the explanations of fundamental points are very easy to understand.

(continued on page 113)

## Do you want to buy a MicroComputer?

Digitus stocks a wide selection of micros and provides expert advice, sizing and design.

Test some robust, proven computers:

- Apple 11
- Cromenco
- DG MicroNova
- North Star Horizon

Choose from a range of peripherals: Shugart, North Star, Sanyo, Sony, Lear Siegler, Cifer, Centronics, Teletype.

Discuss and select a system to fit your present and future needs.

# Digitus

Call, write or visit:  
Digitus Ltd  
Dumbarton House  
68 Oxford Street  
London W1  
Tel: 01-636 0105

● Circle No. 197

PS Also provided:

*micro skill, software, books and training.*

## Does your MicroComputer need software?

Digitus supplies application programs, systems, and tailormade software systems.

We specialise in business and administration programs for Z80/8080 and MicroNova computers including:

- Wordprocessing
- Mailing
- Sales Ledger
- Purchase Ledger
- Nominal Ledger
- Stock Control

Also supplied: systems software for Z80/8080 including CP/M, Extended Basic, Fortran and Interactive Cobol.

# Digitus

Call, write or visit:  
Digitus Ltd  
Dumbarton House  
68 Oxford Street  
London W1  
Tel: 01-636 0105

● Circle No. 199

## Do you need help to design and process your MicroSystems?

Through its MicroSkill Register of over 200 professionals, Digitus provides experienced programmers, designers and engineers to develop systems on most micros including:

- Z80/8080
- LSI 11
- 6502
- MicroNova
- 6800

Some of the Register people have their own machines. Others work on customer or Digitus equipment.

Whether you require a small program written or a large system designed and engineered, Digitus MicroSkill can provide support.

# Digitus

Call, write or visit:  
Digitus Ltd  
Dumbarton House  
68 Oxford Street  
London W1  
Tel: 01-636 0105

● Circle No. 198

PS Applications to join the Register are welcomed. Please send C.V. and two professional references.

## Do you want a MicroSolution for your business?

Some people want to buy equipment and software and bolt it together for themselves.

Others want to buy a solution, a complete system to meet their needs economically and reliably.

Digitus provides MicroSolutions for business, administration and professional practices.

We analyse your requirements, specify systems, choose suitable equipment and software, tailor it to fit your people and organisation, hold hands during transition, train operators and managers, arrange regular maintenance and support.

In short, provide a total MicroSolution.

# Digitus

Call, write or visit:  
Digitus Ltd  
Dumbarton House  
68 Oxford Street  
London W1  
Tel: 01-636 0105

● Circle No. 200



(continued from page 111)

The history of computing is not covered but the book deals with a sensible set of topics. Among them are the definition of a computer as an information processing machine, those capabilities of computers which make them useful to us, their speed, accuracy, and ability to work automatically once they are programmed.

### No excuse

The hardware is examined with many examples, and pictures of input and output devices, though we were surprised at the description of a cathode ray tube as an 'input device'. There is no excuse for inaccuracy and our reviewer could remember being confused by the same point when first introduced to computers.

The way in which the memory unit functions is described with an impressively simple explanation of memory addressing; other internal operations also receive the same kind of treatment. In the section on the control unit there is a lovely picture of it holding hands (handshaking) with all the other components of the system.

The last half of the book introduces the reader to programming and in general we were equally impressed by the style and clarity.

The book ends with a chapter on some applications in modern society. There are examples in medicine, entertainment, art, sport, business, banking and industry, all illustrating the essential versatility of the computer. There is also an excellent low-level glossary of the more common computing terms.

### Conclusions

• Computer literacy is what our society needs today — enough understanding to appreciate the potential and the restrictions. Like other forms of literacy, it should begin at school level. This book is an elegant, well-produced, comprehensive and sympathetic introduction. Highly recommended.—D.W.

### Getting involved with your own computer

by Leslie Solomon and Stanley Veit; published 1977 by Ridley Ensley; paperback, 216 pages; U.S. price: \$5.95.

SUBSTITUTED a guide or beginners, this book is genuinely full of interesting information on most aspects of microcomputers, particularly personal computer systems. Treating it as the low-level introduction it is, we could find no significant omissions in its overview.

One of the authors is technical editor of a U.S. hobby electronics magazine, the other especially

strong on the operation of the hardware, the processor, memory chips and serial and parallel interfaces.

In general, the emphasis is on computer hardware. Software has only one short chapter (10 pages) which introduces machine code, assemblers and high-level languages and explains, neatly enough, what an application program is.

There is no discussion of the techniques to be used in writing and testing programs; even at this level the basics of flowcharting and debugging seem to us to be important elements of home computing, at least as important as the authors' lucid discussion of busses.

On the whole, we liked the organisation of the book. It starts with a chapter on the history of computers from the abacus via Babbage and Hollerith to the single-card computer. That is interesting, particularly the witty asides about the early electronic machines, ENIAC, EDSAC and MANIAC. Did you know ENIAC had 18,000 valves and was expected to fail every 7.5 minutes?

The chapter on where to discover more is usually relegated to one of the appendices in this genre of book but this time it appears early. Of course, anyone reading this magazine will already know where to find what equipment is available but the authors describe helpfully some of the American magazines available — most of which can be obtained here from specialist shops — and follow with some hints on joining clubs, where to obtain technical information, and how to question your local computer shop. There is some good advice in this section and it will be just as useful in this country as in the States.

There is also an early chapter on number systems and binary arithmetic. An appreciation of binary is essential if you want to understand the fine points of how a digital computer works; and it is particularly important with microcomputers, where a good deal of programming is still done in assembler language or machine code.

### Right pitch

Solomon and Veit go into some detail on the various devices which make up the central processor unit — the clock, I/O ports, the micro processor ship. Operation and use are all explained in great detail and an explanation of bus structures follows, concentrating particularly on the widely-used format.

Moving to audio cassette interfaces, the discussion embraces as full a list of the various standards available as we have seen; naturally the top three — Kansas City, CUTS, and Tarbell — are there, Video interfaces, I/O boards, prototyping, extender

boards and the other components for the chassis or motherboard of the microcomputer are covered in enough detail, and that is one of the best aspects of the book.

It is easy for technical people to lay heavy burdens of unnecessary information on a reader; but Solomon and Veit have the pitch right for their kind of reader.

The catch is that you might not be that kind of reader. The blurb describes you as having "an interest in what makes personal computers work and what can be done with them" and presupposes no knowledge of programming or electronics. Well, we think you might occasionally need recourse to the *Practical Computing* glossary to understand a few of the technical buzzwords, but not too often.

Memory devices have a chapter to themselves. ROM, RAM and PROM are explained and so are the workings of static, dynamic and three-state logic RAM — perhaps not too relevant but at least the level of explanation is such that our reviewer has a better understanding of what they mean.

The middle of the book deals with some systems on the market in 1977. There are many obvious changes and additions but all the top-sellers are there.

In a neat summary of applications possibilities, there are no specific projects but a few words on several potential uses — business, word processing, games among the more obvious; home control, robotics, and personal computer networks are ideas encountered less often.

### Conclusions

• We liked the tone of this book as an entry-level introduction. It needs more on software and programming techniques and the authors have a tendency to introduce terms without defining them until later — bootstrap programs are mentioned several times before being explained, and so are ROM and RAM.

• Occasionally Solomon and Veit deal with technical details without giving basic definitions, and some of the definitions that are given are misleading.

• Baud rate is defined as 'bits per second' in the glossary and 'words per second'; both are incorrect, in literal terms at least — 110 baud may be 110 bits per second for a serial interface and 880 bits per second for an eight-bit parallel interface. That apart, the book is a reasonably good introduction — D.W.

### Programming for Microprocessors

By Andrew Colin, published 1979 by Newnes-Butterworths; hard cover, 206 pages; price, £7.95.

THE TITLE is somewhat mislead-

ing. It is not all about programming. In fact, seven of the 12 chapters could more accurately be described as covering systems design. The publishers say it is directed to electronic engineers without computer knowledge and that seems as good a market as one could define for a book which might have been better called *Basic Systems Design* or something similar.

Disregarding the title, it could be a useful book for the microcomputer user interested in how a system works. It might also be of relevance for anyone tempted to try to design a system for a particular function, though anyone who wants to design a computer probably knows most of what is in the book already.

For the daring ones who lack knowledge but would still like to design a system, this would be a useful theoretical introduction. It opens with some general information about microprocessors. Early it points out that correct programs are difficult and expensive to design. If that induces a little caution in the reader, so much the better.

The section on aspects of microprocessor design lists desirable features, most of which would be found in most micros. Of course, this is of no interest to anyone who owns or is thinking of buying a ready-made system where the selection of the micro has been done for you by the manufacturer.

### Clear treatment

On the other hand, machine code programming which might well be of interest to the Pet or TRS-80 user, receives clear and thorough treatment. Because it is impossible to discuss beyond a very general point without becoming specific, there is a chapter devoted to the Motorola 6800 with a very full exposition of its instruction set and the operations related to them.

The section on programming techniques stresses the necessity for structured design. There is an admonition to the effect that anyone trying to write a program with more than about 100 statements will finish with a disaster unless adopting 'hierarchical', or modular approach. There is good sense there and it should encourage the kind of approach one must have to make full use of the potential of any computer.

### Conclusions

• A tasty appetiser for anyone interested in basic systems design; for others, some good hints on machine code programming. If that is your need this is a good-quality publication, well-illustrated, well-written, easy-to-read, and British.—R.G.



# WAVE THE FLAG

At the Adelphi Hotel, Liverpool,  
30th April 1, 2, May 1980

Next Spring sees the birth of the first major Microcomputer Show in the North West of England.

Supported by the Department of Industry, the North West Development Association and the top names in micro applications, the Mersey Microcomputer Exhibition with daily seminars presents a unique showcase in the very heart of the North West business complex.

Book now and fly your flag at advantageous rates. And remember, exhibitors at the 1980 Microcomputer Show, London, and the Mersey Micro Show will be eligible to 10% discount on both events.

Just return this coupon or call Jane McBarnet at:  
Online Conferences Ltd,  
Cleveland Road,  
Uxbridge, Middlesex, UB8 2DD.  
Telephone: 0895 39262.

**online**

Please send 1980 Microcomputer Show Exhibition details.  
 Please send Mersey Micro Show Exhibition details.  
Name \_\_\_\_\_  
Address \_\_\_\_\_  
Tel No \_\_\_\_\_ PC

• Circle No. 201

## November

- **1** **Shugart minifloppy discs.** Venue: Reading. Arranged by Thames Valley Amateur Club, 'The Southcote', Southcote Lane, off Bath Road, Reading.
- **5-6** **Microprocessor project leadership.** Venue: London. Two-day course designed for engineers with sound experience of microprocessors. It will offer the skills necessary to lead a team of engineers developing a microprocessor-based system. Fee: £160. Organised by Bleasdale Computer Systems Ltd, 7 Church Path, Merton Park, London SW19. Telephone: 01-828 6661.
- **5-7** **Microprocessor course.** Venue: Portsmouth Polytechnic. A follow-on three-day course, with a significant amount of time spent in the laboratory. Organised by the Department of Electrical and Electronic Engineering, Portsmouth Polytechnic, Anglesea Road, Portsmouth, PO1 3DJ. Telephone: (0705) 27681.
- **5-9** **Microelectronics for non-electronic engineers.** Venue: London. One-week course gives participants an appreciation of the hardware of a microprocessor and how to construct microprocessor-based systems. Fee: £250. Organised by Bleasdale Computer Systems Ltd, 7 Church Path, London SW19. Telephone: 01-828 6661.
- **6-7** **Fundamentals of computer operations.** Venue: Compower Training School. Designed for trainee and junior dp staff. It gives a basic understanding of the technical aspects, hardware and software concepts, control procedures and provides job orientation. Fee: £125. Organised by Compower Training School, Cannock, Staffs WS11 3HZ.
- **6-10** **Electrical technology and Professional Electronics Exhibition, Finntec 1979.** Venue: Helsinki, Finland. Contact: ECL (Exhibition Agencies Ltd), 11 Manchester Square, London W1.
- **7-9** **Microprocessing.** Venue: Kensington Hilton, London. Three-day course on Applications to process control. Fee: £410 + VAT. Organised by JDB Associates and the International Institute of Science and Technology, 33, Warren Street, London W1P 5DL. Telephone: 01-388 4865.
- **8** **Implications for the curriculum.** Venue: Petersfield School. An evening meeting organised by West Sussex Institute of Higher Education, The Dome, Upper Bognor Road, Bognor Regis, Sussex, PO21 1HR. Telephone: (02433) 5581.
- **12-15** **JCL for programmers.** Venue: Compower Training School. For programmers using IBM equipment to enable them to code their own JCL. Fee: £215. Organised by Compower Training School, Cannock, Staffs, WS11 3HZ.
- **12-16** **Designing systems with microprocessors.** Venue: London. Two-week workshop for engineers with knowledge of microprocessors. Covers designing and producing highly-reliable microprocessor-based systems, with particular emphasis on design and development of structured software. Fee: £250. Organised by Bleasdale Computer Systems Ltd, 7, Church Path, Merton Park, London, SW19. Telephone: 01-828 6661.
- **12-30** **Cobol.** Venue: Compower Training School. Course for trainee programmers includes an introduction to programming, flowcharting techniques, structuring, coding techniques, documentation and standards. Fee: £645. Organised by Compower Training School, Cannock, Staffs, WS11 3HZ. Telephone: Cannock 2511.
- **13-16** **Microcomputers in manufacturing and industrial control.** Venue: London. Four-day microprocessor course designed for manufacturing and process control engineers and managers. Fee: £470 + VAT. Organised by Integrated Computer Systems UK, Peblecoombe, Tadworth, Surrey, KT20 7PA. Tel: (03723) 79211.
- **14-15** **Microprocessor development systems and their use.** Venue: Manchester. Two-day seminar to demonstrate how to select a microprocessor development system and operate it cost-effectively. Fee: £60 per day + VAT. Organised by Prodex (Seminars) Ltd, 79, High Street, Tunbridge Wells, Kent TN1 1XZ. Tel: (0892) 39664.
- **16** **Computer studies in school.** Venue: Bognor Regis. Organised by West Sussex Institute of Higher Education, The Dome, Upper Bognor Road, Bognor Regis, Sussex, PO21 1HR. Telephone: (02433) 5581.
- **19-23** **Microprocessor design and development.** Venue: Sevenoaks, Kent. Five-day residential course designed for project managers and engineers concerned with incorporating microprocessors into measurement and control equipment. Fee: £480 + VAT. Organised by The Sira Institute Ltd, South Hill, Chislehurst, Kent, BR7 5EH. Telephone: 01-467 2636.
- **19-30** **Systems analysis and design for new systems staff.** Venue: Compower Training School. Covers systems justification, fact-finding and analysis and all aspects of systems design. Fee: £480. Organised by Compower Training School, Cannock, Staffs, WS11 3HZ.
- **20-23** **Principles of 2900 operating.** Venue: Compower Training School. For staff with at least three months' operating experience; enables them to play their full part in a 2900 environment. Fee: £215. Organised by The Compower Training School, Cannock, Staffs, WS11 3HZ.
- **21** **Teaching software design techniques for microprocessors.** Venue: London. A forum for discussing methods of teaching software design techniques and to highlight the experience of those responsible for teaching the subject in academic and industrial environments. Organised by Conference Department, IEE, Savoy Place, London, WC2 0BL. Telephone: 01-240 1871.
- **27-30** **Introduction to supervision.** Introduces supervisory principles to all operations staff below management grades. Practical syndicate exercises are related to work situations. Fee: £215. Organised by Compower Training School, Cannock, Staffs, WS11 3HZ.
- **27-30** **Microprocessors and microcomputers.** Venue: London. Comprehensive introduction with hands-on workshops, designed for engineers, scientists, systems analysts and managers. Organised by joint technical education activity of Integrated Computer Systems and the Polytechnic of Central London, Peblecoombe, Tadworth, Surrey, KT20 7PA. Telephone: (03723) 79211.
- **27-30** **Satellite communication and navigation systems.** Venue: London. Four-day course giving in-depth coverage of state-of-the-art, technologies of earth/satellite and satellite/earth communication links. Fee: £470 + VAT. Organised by Integrated Computer Systems UK, Peblecoombe, Tadworth, Surrey, KT20 7PA. Telephone: (03723) 79211.
- **27-30** **Structured programming.** Venue: London. Four-day course in scientific and engineering applications designed for engineers, scientists, programmers, analyst managers and users responsible for the planning, design and implementation of complex program structures. Fee: £470 + VAT. Organised by Integrated Computer Systems UK, Peblecoombe, Tadworth, Surrey, KT20 7PA. Telephone: (03723) 79211.
- **27-30** **Computer graphics.** Venue: London. Four-day course on state-of-the-art techniques and applications, designed for analysts, programmers, design engineers and program managers with responsibility for configuring and implementation computer graphic systems. Fee: £470 + VAT. Organised by Integrated Computer Systems UK, Peblecoombe, Tadworth, Surrey, KT20 7PA. Telephone: (03723) 79211.



# CAUSE FOR CELEBRATION

At the Wembley Conference Centre.  
22nd to 24th July 1980

This exhibition, international conference and six seminars adds up to the most significant microcomputer event ever held in the U.K.

Join the top names in the business and book your space now at advantageous rates.

And remember, some exhibitors will have an additional cause for celebration: Exhibitors at the Mersey Micro Show and the 1980 Microcomputer Show are eligible to 10% discount on both events!

## The 1979 Microcomputer Show



## What the Exhibitors said

"Still suffering from shell-shock. We are now getting over 100 enquiries a week" **Tony Winter, Joint Managing Director, Grama (Winter) Ltd.**

"Best micro show so far. Visitors were enthusiastically spending money and placing orders" **Kerr Borland, Managing Director, Nascom**

"An outstandingly successful show" **Mike Sterland, Managing Director, Personal Computers Ltd.**

## What the Papers said

"Micro mania hits London - staggering success - the sort of frenzy usually seen at January sales" **Datalink.**

"Show's switch to small business systems was a great success" **Computer Weekly.**

"Online scores a treble-record crowds" **Electronics Weekly.**

**online**

Just return this coupon or call Jane McBarnet at Online Conferences Ltd, Cleveland Road, Uxbridge, Middlesex UB8 2DD. Telephone: 0895 39262.

Please send 1980 Microcomputer Show Exhibition details

Please send Mersey Micro Show Exhibition details

Name \_\_\_\_\_

Address \_\_\_\_\_

Tel No \_\_\_\_\_

PC

• Circle No. 202

## Business applications

DEREK ROWE'S company has two TRS-80s running business applications. This progress report states:

"Recently we added two mini-disc drives which work through an expansion interface with a further 16K — the Disc Basic limites the effective increase to 10K.

"So far there have been no breakdowns and virtually no problems with Level II Basic. Even the infamous keyboard bounce is within acceptable limits and it can be eliminated altogether by a software fix provided in the disc system.

"There is a more serious problem which may affect some systems; occasionally everything freezes-up during a program run and RESET provides the only re-start. Tandy is apparently aware of the problem which is due to suspect memory chips; replacement by a high-quality alternative provides the solution.

"A similar but unrelated hiccup takes the form of noticeable pauses. They occur solely with one program which uses a large amount of string space — CLEAR 4000. The delay seems to be caused by machine operation on the string variables; re-programming to reduce string usage, combined with an increase in reserved string space, reduces the number of pauses significantly. Tandy has not produced an answer to this.

## Increased potential

"We are now very satisfied with our disc system and it has increased the potential of application areas significantly. Our first week with it was a complete disaster. Fortunately we had considerable assistance from the TRS-80 specialist with whom we do business but the main problems were:

- Inability to SAVE/LOAD programs from disc without continual I/O errors.
- Complete loss of data on a number of discs.
- Total failure of attempted back-up operations.

"Our difficulties were caused by hardware faults compounded by ignorance of the correct way to handle the equipment. Some of the solutions we employed must have a general relevance:

- Install mains filters on the power supply to the system as a whole and also on each disc drive. Even so there is still a risk of corrupting the system if the nearby printer is switched on or off during operation.
- Buy an electronic 'bulk eraser'. Once a disc has been formatted, it is impossible to re-format without first erasing it first; an ordinary magnet is not a reliable alternative.
- Obtain a modified buffered expansion interface. This has an improved approach to the data links.
- Change faulty disc drives. Faults are shown by messages such as 'Motor

speed too slow' or 'Disc trap not closed'.

- Implement a software fix to allow retry with I/O errors and avoid a possible system contention.
- Keep floppy discs in a metal cabinet with back-up copies in another separate cabinet.

"The early problems have now been almost totally eliminated; certainly I/O errors with LOAD/SAVE under Basic are now virtually unknown. We are still experiencing failures with BACKUP, COPY and DISC I/O errors with the disc-based version of the Electric Pencil word processing package. We think this may be an internal error due to inadequate verification by the package.

## New release

"Problems with BACKUP and COPY may also be due to less-than-perfect cleaning of the source disc or perhaps a problem with DOS. A new release of the operating system is imminent; a number of problems, like keyboard bounce, will be cured in this and I/O integrity may also be enhanced.

"Provided saved files are always test loaded before clearing the system, there is a minimal danger of losing programs. Even with BACKUP failures, individual programs can usually be accessed by COPY or the LOAD/SAVE sequence."

## Debounce fix

AFTER a struggle, writes Ed Phipps of Nantwich, I have implemented A. J. Harding's software fix for the TRS-80 keyboard bounce on my 4K level II, using simple Basic commands. Surely there must be many other users without access to assemblers — and hence somewhat 'machine code blind', like me — but who still need a debounce?

The program seems to work well. The only messy bit is line 6 — I can't seem to get around the error message without losing the 'fix'. Is there a better way of calling the code?"

Instructions: on switching on, answer MEMORY SIZE? with 20425. Load the program, run, and follow instructions given. After erasure, 3,230 bytes remain for Basic programs.

```
1POKE16526,201:POKE16527,79
3DATA75,17,10,0,205,11,0,25,34,22,64,205,97,27,207,
25,26,33,54,64,1,1,56,22,0,10,95,174,115,163,32,8,20,44,
203,1,242,226,79,20,1,95,197,1,220,5,205,96,1,10,163,200,
195,251,3
4S=20425:E=20479
5FORA=STOE:READB:POKEA,B:NEXT:CLS
6PRINTTAB(15)"DEBOUNCE":PRINT?448,***
7IGNORE ERROR MESSAGE***:PRINT"HIT ENTER",
8THEN TYPE 'NEW' AND HIT ENTER AGAIN.:PRINT
9"KEYBOARD WILL THEN BE FULLY DEBOUNCED
10AND MEMORY CLEARED: ONLY 54 BYTES
11RESERVED":PRINT?128,
126X=USR(0)
```

Line 1 puts the start address of machine code program in the USR address location. Line 4 gives start and finish addresses for placing the machine code detailed in line 3. Line 5 places code in locations specified; instructions printed

will follow the error message. Line 6 calls the code and causes it to operate. It results in a syntax error hence the instructions in line 5.

To write this initially I used Basic sub-routines for hex/decimal interconversions, PEEK, POKE, and so on. Is it possible to produce a competent mini-assembler using Basic? Presumably memory space and speed could pose problems? Any ideas of sources for TRS-80 Basic listings and ways of creating machine code files on tape?

## Control jack

TRS-80 owners might be interested to know that it is not necessary to pull out the remote control jack, or to install a switch to recover control of the tape recorder after a CSAVE or CLOAD, to permit re-winding, writes I. R. Sinclair. The following will do the same job:

5 out 225,4 : goto 5 (ENTER)

When you want to resume, press BREAK.

Incidentally, this looks like being the first step to a problem I'm trying to solve. Cassette data files are very tedious and cause wear on the cassette motor relay inside the TRS-80 because each data line is preceded by the start routine, followed by the end routine, and with a motor switch-off.

I am trying to find a way to permit one start-up routine, followed by several lines of data, then a single switch-off, as happens during a CSAVE or CLOAD. A routine like this might make the use of INPUT -1 and PRINT -1 much more useful; at the moment, a few lines of data take up more space than the program which generates the data.

## Free Life

IF ANY TRS-80 Level II user would like to send a stamped addressed envelope to C Paradine, 59 Merdon Avenue, Chandlers Ford, Hampshire, he will provide a fast, machine-language cassette for Life. In return, he would like to hear about any interesting patterns users discover — in particular, shapes which move about, reproduce or destroy each other.

## Software

WE HAVE been sent the first copy of a useful-looking magazine, *TRS-80 Software*. It costs £1 for 19 pages 15cm x 21cm. The issue contains a disc Basic text-editor, a review of the NEWDOS operating system and a Tank Battle game. From: TRS-80 Software, 3 Line Computing, 421 Endike Lane, Hull, HU6 8AG.

## Group

WE NEGLECTED to mention the national TRS-80 Group in our August issue. Brian Pain is the secretary, on 0908 566660 (during office hours) — 40a High St, Stony Stratford, Milford Keynes. 

**NEW from NEWTRONICS**  
**'EXPLORER 85'**  
**microcomputer kit**  
**Low Cost with On-Board**  
**S100 expansion**  
**at £295 + VAT**

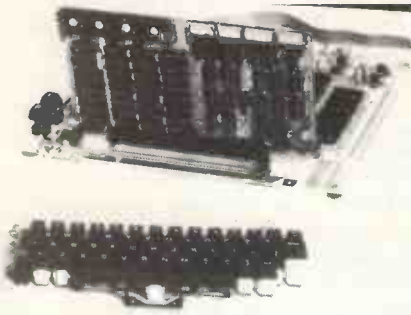

- The 'EXPLORER 85' is inexpensive with all the advantages of a powerful board plus potential for 'infinite' expansion.
- Uses New Fast INTEL 8085 cpu, 100% compatible with 8080A software but 50% faster than 8080A cpu.
  - Powerful 2 K monitor.
  - 4K user RAM expandable to 64K.
  - Provision for 8K PROM or EPROM.
  - Buffered & decoded S100 expansion on board (up to 6 S100 boards).
  - Cassette Interface (with motor control & cassette file structure) RS232 : 20ma loop: 4 8bit & 1 6bit I/O ports.
  - Programmable 14 bit binary counter/ timer.
  - Separate ASC11/Video Terminal features: — a full 128 character set upper/lower case, full cursor control, Greek symbols for Maths, 75 ohm video output convertible to baudot output, selectable baud rate, RS 232 or 20ma loop, I/O. 64 or 32 characters by 16 line (monitor or TV).
  - And lots of other great features.
  - Send SAE for Full Specification.

	Price Ex VAT	P&P
<b>LEVEL 'C'</b> S100 main frame expander kit. Increases the number of S100 slots to 6. Includes all sheet metal, 5 slot extender board, board-guides & brackets. Fits into EXPLORER cabinet. (less S100 pin connectors).	32.80	2.00
<b>LEVEL 'E'</b> Add 8K sockets, power supply regulator & decoupling components for popular 2716 or 2516 EPROMS (EPROMS not included)	5.00	Free
<b>DE LUXE STEEL CABINET FOR EXPLORER 85</b>	35.50	2.00
<b>DE LUXE STEEL CABINET FOR VIDEO KEYBOARD TERMINAL</b>	15.00	2.00
<b>POWER SUPPLY IN STEEL CABINET.</b>	25.00	2.00
<b>GOLD PLATED S100 BUS CONNECTORS.</b>	4.00	Free
<b>RF MODULATOR 8kHz</b> required when using TV set serial socket.	6.00	Free
<b>S100 16K RAM EXPANDABLE</b> Expandable to 60K on one board	165.00	2.00
<b>INTEL 80805 Users Manual</b>	6.00	Free
<b>8K 'MICROSOFT' BASIC ON CASSETTE TAPE</b> The most versatile and popular basic ever written. Complete with documentation.	53.00	Free

**NEWTRONICS KEYBOARD TERMINAL**

The Newtronics Keyboard Terminal is a low cost stand alone Video Terminal that operates quietly and maintenance free. It will allow you to display on a monitor 16 lines of 64 characters or 16 lines of 32 characters on a modified TV (RF Modulator required).  
 The characters can be any of the 96 ASC11 alphanumeric and any of the 32 special characters in addition to upper-lower case capability it has scroll up features and full X-Y cursor control. All that is required from your microcomputer is 300 baud. RS232 C or 20ma loop serial data plus a power source of 8v DC & 6.3v AC. The steel cabinet is finished in IBM Blue-Black. And if that is not enough the price is only £135.55 + VAT as a Kit, or £175 + VAT assembled and tested. Plus £2 P&P (Monitor not included).

**NOW AVAILABLE  
 8K FULL BASIC  
 FOR ELF11**

**NEW! NOW  
 'NEWSOFT' GAMES for ELF11  
 4 GAMES for £5.00  
 send for list.**



**BUY A ELF 11  
 microcomputer only  
 for less than £79.95  
 + VAT  
 some TV games**

**ADD-ONS**

- |   |       |
|---|-------|
| • POWER SUPPLY (6.3V AC) for ELF 11                                       | 5.00  |
| • ELF 11 DE LUXE STEEL CABINET (IBM Blue)                                 | 23.01 |
| • GIANT BOARD KIT System/Monitor, Interface to/ cassette — RS232, TTY etc | 35.00 |
| • 4K STATIC RAM board kits (requires expansion power supply)              | 69.44 |
| • Expansion power supply (required when adding 4K Rams)                   | 19.00 |
| • ASC11 Keyboard Kits 96 printable characters etc                         | 50.58 |
| • ASC11 d/lux steel cab. (IBM Blue)                                       | 15.02 |
| • KLUGE prototype board (build your own circuits)                         | 12.83 |
| • 86 pin Gold plated connectors, Each                                     | 4.00  |
| • ELF Light pen writes/draws on TV screens                                | 6.50  |
| • Video graphics board 32/64 characters by 16 lines on TV/monitor screens | 69.95 |
| • ELF 11 Tiny basic on cassette   | 13.50 |
| • ELF 11 Bug/monitor powerful systems monitor/ editor                     | 13.50 |
| • T. PITMANS short course in programming manual (Nil VAT)                 | 4.00  |
| • T. PITMAN short course on tiny basic manual (Nil VAT)                   | 4.00  |
| • RCA 1802 users manual (Nil VAT)   | 4.00  |
| • On cassette Text Editor: Assembler, Disassembler. Each                  | 16.95 |
- SAVE 10% AND BUY ALL THREE TOGETHER**  
 All units can be supplied wired and tested

**Ex VAT**

**ELF 11 BOARD WITH VIDEO OUTPUT**

STOP reading about computers and get your "hands on" an ELF 11 and Tom Pitman's short course. ELF 11 demonstrates all the 91 commands which an RCA 1802 can execute, and the short course speedily instructs you how to use them.  
 ELF 11's VIDEO OUTPUT makes it unique among computers selling at such a modest price. The expanded ELF 11 is perfect for engineers, business, industry, scientific and educational purposes

**SPECIFICATION**

- RCA 1802 8 bit microprocessor with 256 byte RAM expandable to 64K bytes
- RCA 1861 video IC to display program on TV screen via the RF Modulator
- Single Board with professional hex keyboard fully decoded to eliminate the waste of memory for keyboard decoding circuits
- Load, run and memory project switches
- 18 registers
- Interrupt, DMA and ALU
- Stable crystal clock
- Built in power regulator
- 4 slot plug in expansion bus (less connectors)

**SEND SAE FOR COMPREHENSIVE BROCHURE**

Name .....

address .....

.....

Barclaycard/Access .....

.....

**To Newtronics 138 Kingsland Road  
 London E2 8BY Dept P/C  
 Tel: 01-739 1582. SOLE UK AGENTS.**

## Software news

THE IPUG swop library has made a good start and a new program has been added to those which IPUG offers cheap to members. This is a version of SPACEWAR with very intelligent Klingons; it works in real-time with nasty sound effects when things go wrong. There are nine levels of play but I have never managed to survive above level 5. The sound interface is the one mentioned in the February *Practical Computing*.

The program, like the Renumberer, PR40 interface and the Music/Organ/Morse programs, costs £2.50 to members — £5 to non-members. Don't forget, membership is £2.50 for 1979. Contact, Mike Lake, IPUG, 9, Littleover Lane, Derby.

## Sound

ON THE SUBJECT of sound programs and interfaces, Mike Lake has had a chance to try the Sound Box offered by Petsoft. It is a small black box, containing a 0.1 watt speaker and the minimum of electronics to form an amplifier which plugs into the second cassette interface. Power is drawn from Pet so no battery is needed. The unit is offered with a demonstration program written by HB Computers of Kettering.

The unit does not seem particularly good value at £13.99 plus 75p p&p. The quality of sound is not good. Programming for music would be difficult and the only good thing to say about it is that it allows you to hear data being streamed-out to cassette when you SAVE or PRINT to cassette unit number 1.

By far the best way to produce sound is from the user port, since this uses the 6522 VIA to produce very clear notes. To produce good sound, connect the user port to any amplifier. If someone would care to produce a cheap amplifier for the user port, complete with connector, on/off switch, volume control and at least 0.5 watt output, many Pet users would certainly be interested, though, as mentioned previously, an Eagle Intercom at about £6 can be used just as well with the right connector.

## Inspired

I WAS inspired by your July issue to connect my Pet to a mainframe computer via a Small Systems Engineering interface. Although Michael Whitehead and Pet Users' Club both assert that it is not possible to do this in Basic, I have had no trouble:

It is certainly adequate as a back-up machine for my Teletype. Admittedly there is no time for any sophistication, even though I have shortened line 2 to the minimum possible length and given top priority to incoming characters. I have timed it carefully and the transmission speed is certainly 10 characters per second, writes Laurence Chatfield.

I intend to use machine language on 30 characters per second and save output from the mainframe in core, so that I can



list it out after putting down the telephone. This should save me between £200 and £400 per year, so I think my subscription to your magazine is well worth it.

There is one snag. I cannot simulate the Teletype break signal on the Pet — it is not a character — and this is the only signal the mainframe recognises as an interrupt. Can anyone suggest something? At the moment I have to pull-out the plug if I have a lot of unwanted output.

## Query

PROVIDED I have not opened the Pet and have connected no equipment to it, can I or not do any damage to the keyboard? There are admonitions in the manual, writes W. Green, such as "This could kill you if you touch the keys," "Be prepared to re-set your machine" and "The beginner should not undertake such and such." Do these remarks mean that I would not get the desired results? Can I POKE or PEEK anything I like, just to see what happens?

In principle, there is nothing you can do at the keyboard which will damage the machine, other than your program which can all too easily be ruined. If finger slips smash machines, we would like to hear about it.

## Floppies

THE COMPUTHINK disc drives using the DISKMON operating system have been around for a few months and apparently have many happy users. The unit offers 200KB user storage and is quick in handling large random access files.

After a short time with it Mike Lake was also impressed with its speed; it was loading a 20K program in about six seconds and finding random records within a large file in less than three. To try the disc he set up a file containing 780 128-byte records and then accessed at random.

At first, the speed seemed unbelievably fast, less than 0.5 second per record; on checking the program — which used the RND function to generate a random number from 1 to 780 — Mike found that the same number was being obtained every time. Apparently the DISKMON operating system overwrites the random number seed in the first 1K of memory and so the same random number appears

again and again.

One or two annoying things spoiled an otherwise excellent drive. A FRE(O) after loading a program had a habit of hanging-up the system, requiring that the Pet be turned off and on to clear it. Using sequential files would seem to be difficult, since only one file could be open at one time. The solution to this is fairly simple — don't use sequential files. Instead, set up large random access ones which can be handled very quickly indeed.

The DISKMON system requires the use of a PETBIT memory board which provides an extra 24KB memory on the standard 8K Pet. The disc controller program is contained in EPROM and use is made of some of the extra RAM to store data which is going to and from the disc. The speed of the system is mainly a result of its picking-up a whole track at each read and then allowing access to it from RAM.

At the end of last year, Midland Micro-nics was offering a dual-drive system for the top of the Pet, retaining the all-in-one image. We understand there have been financial problems in putting this product fully on to the market but now the system is being made and sold by Analog Electronics of Coventry, under the name of the Novapac.

## Useful features

The Novapac is placed on top of the VDU of the Pet and the two Wang drives give the Pet the look of an elephant with two large ears. The PDOS operating system supports files kept on diskette in standard IBM format, giving about 80K of user space per diskette.

The operating system offers many useful features — including password protection on writing, so that your files cannot be over-written without someone knowing the password. Each diskette is divided into 40 tracks, each containing 16 sectors of 128 bytes. Read and write operations are at the sector level and the second cassette buffer is used to store sectors read in or ready to write out.

The system uses an Intel 8048 micro and a Western Digital 1771B disc controller; 512 bytes of PROM are provided to boot the system which then resides in 8K at the top of memory. Obviously this means that the unit can be used only on expanded Pets. The interface is connected to the memory expansion board and provides a piggy-back arrangement for anything else plugged in there.

Both the Computhink and the Novapac are set up to use the 8K Pets with expansion memory; both are in the range £800 to £900 before VAT.

## Co-ordinator required

MIKE LAKE of IPUG is having to relinquish his role as the prime source of input to Pet Corner. So we are looking for someone to take over the mantle. Write if you are interested to Pet Corner at *Practical Computing*. 

# MICROAID—the winning entry

FEW MARRIAGES would appear to have dimmer prospects of success than the one between the rigorous and highly-mathematical applications of computers and the descriptive, empirical and often intuitive approach of the microscopist. Nevertheless, the computer has certain features which permit it to assist in identification problems: it can have an extremely large, permanent and reliable memory; it calculates quickly and the information in its memory can be available when required.

The computer is not influenced by recent experience and personal bias; it can be updated easily but it cannot do the physical examination. At present, for example, it is unable to carry-out the examination of the microscopy of a powdered sample or convert narrative or pictorial information for its use. The program required to imitate completely an experts' thinking would be impracticably

This is an edited version of the documentation accompanying the winning program MICOAID which won the Program of the Year competition for Drs Georgina and Geoffrey Jolliffe.

large. Advances in pattern recognition, however, will undoubtedly contribute to that end in due course.

There is scarcely an area of study or specialisation which the computer has not touched in one way or another, although there are vast differences in the amount of involvement existing between various fields. It is, therefore, surprising to find a singular lack of application of the computer as an aid to identification of powdered vegetable drugs or foods until the introduction of our programs DRUGID and FOODID in 1976. They involved the use of a main frame computer (KRONOS CDC 6600) and the main disadvantages were:

- the difficulty obtaining access at any given instant;
  - the terminal was situated inconveniently three floors away.
- The program MICROAID was developed to give all the advantages accruing from the use of a microcomputer system:
- the computer can be situated in the laboratory;
  - the complete system can be moved easily to other laboratories as required;
  - the system is under full personal control;
  - it is accessible at all times for a given individual;
  - the capital cost is a fraction of that of a mainframe computer and running costs are negligible — telephone charges for connection to a computer from a terminal are high.

## More efficient

Simple translation of the program DRUGID to suit the TRS-80 proved to be rather slow in use because of the large number of numeric calculations involved and this motivated the development of a new, more efficient programming process.

An analyst may be called upon to identify a powdered crude drug and absolute identity requires detailed microscopic examinations as an essential part of the analytical technique. Reference is then made to suitable keys tables, atlases or a punched-card system. That approach, of necessity, is laborious and considerable experience is required to enable the analyst to identify the powder by microscopy.

## Problems

The use of reference atlases, while a valuable aid in confirming identity, does not produce a systematic approach to the problem of identification of powdered vegetable drugs. Tables of histological features are sometimes difficult for the inexperienced analyst to interpret as the description, particularly "inflorescences and floral members" and "seeds and fruits" may apply to the powdered drug or, sometimes, it is more appropriate to the sectional appearance of the drug.

Before an atlas or table can be used, the drug must be referred to its morphological group; error at this stage is time-consuming and results frequently in incorrect identification. The punched-card system requires the assessment of more than 100 characters, some of which

## DATA SHEET

CHARACTERS — Enter + if character present, — if absent	No.	+ / —
	Prisms	1
	Needles	2
CALCIUM OXALATE .....	Sphenoids	3
	Clusters/Rosettes	4
	Microcrystals	5
	Crystal Layer	6
ALEURONE ** .....	Crystal Sheath*	7
CORK .....		8
LIGNIFIED PARENCHYMA .....		9
		10
	Anomocytic	11
STOMATA .....	Anisocytic	12
	Paracytic	13
	Diacytic	14
	Actinocytic	15
	Graminaceous	16
	Covering	17
	Unicellular	18
	Multicellular	19
TRICHOMES .....	Glandular	20
	Stalk Unicellular	21
	Stalk Multicellular	22
	Head Unicellular	23
	Head Multicellular	24
	Lignified	25
VESSELS/TRACHEIDS .....	Non-lignified	26
STONE CELLS .....		27
FIBRES .....		28
STARCH .....		29
POLLEN .....		30

\* or calcium oxalate localised in the region of the main veins

\*\* protein as grains or amorphous

- NOTES**
- 1) Remember GIGO (garbage in, garbage out). The output information can reflect only the accuracy of your observations. If you should make only a few mistakes, however, the output will give some guidance to indicate the location of errors.
  - 2) The program MICROAID requires the input of SIX blocks of FIVE digits with each block separated by a single space. Only the digits 1 and 2 may be used. Any variation will cause an error message to appear on the screen and the data will have to be re-entered.
  - 3) If a hard copy is required the printer should be switched-on and set to print (SELECT ON).



are difficult for the inexperienced analyst to interpret and moreover, entails micro-scale measurements.

The microcomputer is an ideal tool to aid the inexperienced microscopist to identify rapidly and correctly a powdered drug from as comprehensive a list as possible, not necessarily limited to those in commercial demand. The main problems were, therefore,

- to convert a large data matrix of information into a format suitable for rapid comparison with input data;
- to make allowance for histological features of the powdered vegetable drug present which could be missed due to their relative infrequency;
- to provide a facility for ascertaining the validity of the databank by use of a check digit;
- to keep input data as simple as possible;
- to check that input data is valid;
- to keep the user informed of processing progress, since a blank or unchanging screen while data processing is somewhat frustrating;
- to produce output data in ascending order of errors — the most likely powders to be listed first;
- to provide an option for hard-copy output, if desired;
- to help the analyst by indicating the possible sources of error in his microscopic observations, especially when complete identity is not achieved from his input data;
- to warn the user that final identity must be made only after comparison with an authentic sample — thus avoiding the "calculator" syndrome . . . . . "the computer says the drug is . . . . ."; which is a common student error.

## The program

The program contains a databank of 174 powdered vegetable drugs together with a list of nine morphological groups. Each powder in the databank consists of up to nearly 50 alphanumeric characters. The first 30 indicate, in coded form, the presence or absence of certain histological features. Character 31 is a number from 1 to 9 corresponding to the appropriate morphological group. Character 32 is a check digit based on the first 31 characters; the remaining characters spell out the name of the powder.

Considering the first 30 characters, a "1" represents a histological feature which is definitely absent, "2" a histological feature which is definitely present and "3" a histological feature which is present but often in such a small amount that it could be missed by the inexperienced microscopist.

The input information required from the user is a string of coded characters comprising six blocks of five digits which indicate the absence or presence — 1 or 2

(continued on page 123)

## Listing 1

```

10 PRINT "START ADDR";:INPUT A$:A=0
20 FOR K=1TO4
30 IF MID $(A$,K,1) >="A" THEN 50
40 A=A*16+VAL(MID $(A$,K,1)):GOTO 60
50 IF MID $(A$,K,1)="A" THEN A=A* 16+10
51 IF MID $(A$,K,1)="B" THEN A=A* 16+11
52 IF MID $(A$,K,1)="C" THEN A=A* 16+12
53 IF MID $(A$,K,1)="D" THEN A=A* 16+13
54 IF MID $(A$,K,1)="E" THEN A=A* 16+14
55 IF MID $(A$,K,1)="F" THEN A=A* 16+15
60 NEXT
70 PRINT "NO. LINES";:INPUT NL
80 FOR LN=1 TO NL
85 N=0:L=A:GOSUB 2000
90 D=PEEK(A):L=PEEK(A+1):H=PEEK(A+2)
100 IF (D AND 227)=97 THEN PRINT "ADC";:GOTO 1000
105 IF D=32 THEN PRINT "JSR";:N=3:GOTO 990
106 IF D = 76 THEN PRINT "JMP";:N=3:GOTO 990
107 IF D=108 THEN PRINT "JMP IND";:N=3:GOTO 990
110 IF (D AND 227)=33 THEN PRINT "AND";:GOTO 1100
120 IF D=144 THEN PRINT "BCC";:N=2:GOTO 1100
130 IF D=176 THEN PRINT "BCS";:N=2:GOTO 1100
140 IF D=240 THEN PRINT "BEO";:N=2:GOTO 1100
150 IF D=48 THEN PRINT "BMI";:N=2:GOTO 1100
160 IF D=208 THEN PRINT "BNE";:N=2:GOTO 1100
170 IF D=16 THEN PRINT "BPL";:N=2:GOTO 1100
180 IF D=80 THEN PRINT "BVC";:N=2:GOTO 1100
190 IF D=112 THEN PRINT "BVS";:N=2:GOTO 112
200 IF D=24 THEN PRINT "CLC";:N=1:GOTO 980
210 IF D=216 THEN PRINT "CLD";:N=1:GOTO 980
220 IF D=88 THEN PRINT "CLI";:N=1:GOTO 980
230 IF D=184 THEN PRINT "CLV";:N=1:GOTO 980
240 IF D=202 THEN PRINT "DEX";:N=1:GOTO 980
250 IF D=136 THEN PRINT "DEY";:N=1:GOTO 980
260 IF D=232 THEN PRINT "INX";:N=1:GOTO 980
270 IF D=200 THEN PRINT "INY";:N=1:GOTO 980
280 IF D=234 THEN PRINT "NOP";:N=1:GOTO 980
290 IF D=72 THEN PRINT "PHA";:N=1:GOTO 980
300 IF D=8 THEN PRINT "PHP";:N=1:GOTO 980
310 IF D=104 THEN PRINT "PLA";:N=1:GOTO 980
315 IF D=40 THEN PRINT "PLP";:N=1:GOTO 980
320 IF D=64 THEN PRINT "RTI";:N=4:GOTO 980
330 IF D=96 THEN PRINT "RTS";:N=1:GOTO 980
340 IF D=56 THEN PRINT "SEC";:N=1:GOTO 980
350 IF D=248 THEN PRINT "SED";:N=1:GOTO 980
360 IF D=120 THEN PRINT "SEI";:N=1:GOTO 980
370 IF D=170 THEN PRINT "TAX";:N=1:GOTO 980
380 IF D=168 THEN PRINT "TAY";:N=1:GOTO 980
390 IF D=186 THEN PRINT "TSX";:N=1:GOTO 980
400 IF D=138 THEN PRINT "TXA";:N=1:GOTO 980
410 IF D=154 THEN PRINT "TXS";:N=1:GOTO 980
420 IF D=152 THEN PRINT "TYA";:N=1:GOTO 980
430 IF (D AND 227)=2 THEN PRINT "ASL";:GOTO 999
440 IF (D AND 227)=32 THEN PRINT "BIT";:GOTO 1000
450 IF (D AND 227)=193 THEN PRINT "CMP";:GOTO 1000
460 IF (D AND 227)=224 THEN PRINT "CPX";:GOTO 998
470 IF (D AND 227)=192 THEN PRINT "CPY";:GOTO 998
480 IF (D AND 227)=65 THEN PRINT "EOR";:GOTO 1000
490 IF (D AND 227)=226 THEN PRINT "INC";:GOTO 1000

```

THE BEST COMPUTER PROGRAMS ARE BASED ON A FLOWCHART. TRY OUR FLOWCHART FOR THE BEST VALUE WITH FIRST-CLASS ADVICE & SERVICE.

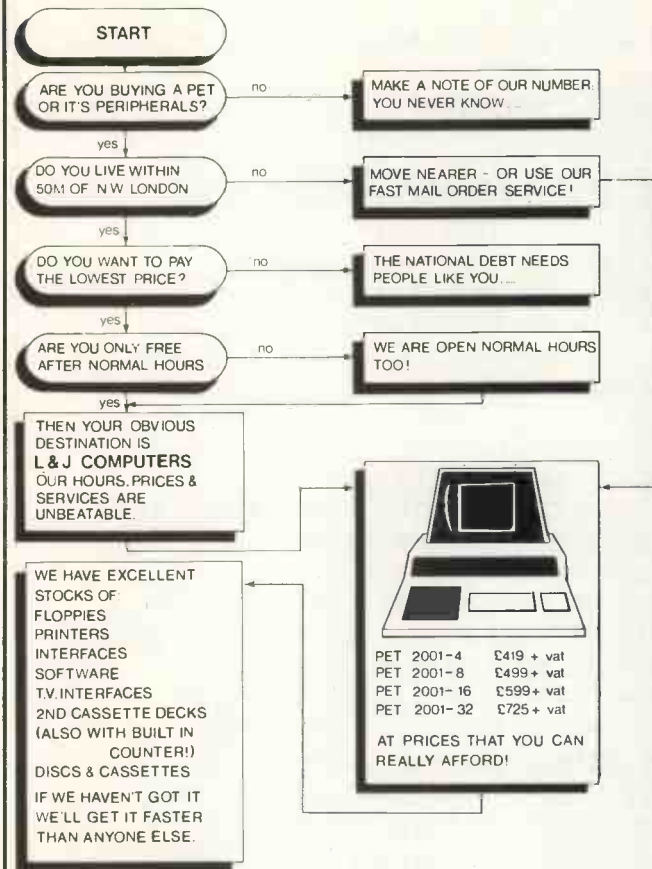

WE HAVE EXCELLENT STOCKS OF FLOPPIES PRINTERS INTERFACES SOFTWARE TV. INTERFACES 2ND CASSETTE DECKS (ALSO WITH BUILT IN COUNTER!) DISCS & CASSETTES IF WE HAVEN'T GOT IT WE'LL GET IT FASTER THAN ANYONE ELSE.

PET 2001-4 £419 + vat  
 PET 2001-8 £499 + vat  
 PET 2001-16 £599 + vat  
 PET 2001-32 £725 + vat

AT PRICES THAT YOU CAN REALLY AFFORD!

**SPECIAL OFFERS**  
 BLANK C12, C22 CASSETTES (HIGH PERFORMANCE) 10 FOR £3.20  
 TRACTOR FEED PAPER (LINES) 11X 8 1/2 ins. BOX 2000 FOR £10.90  
 PR40 PRINTER WITH FITTED INTERFACE - £295.00  
 (USES NORMAL PRINT ROUTINES)  
 PR40 INTERFACE AND FITTING INSTRUCTIONS £63.00  
 PR40 INTERFACE FITTED TO YOUR MACHINE (48HR. SERVICE) £73.00  
 PRICES DO NOT INCLUDE VAT OR P&P

**SYSTEM OF THE MONTH**

32K PET + FLOPPY DISC DRIVE + INTERFACE + 779 CENTRONIC PRINTER

M.R.P.: £2585 + VAT. OUR PACKAGE PRICE: ONLY £2299 + VAT

WILL ADEQUATELY SERVICE MOST SMALL COMMERCIAL NEEDS. WE WILL TAILOR MAKE SOFTWARE FOR YOU AT REASONABLE PRICES.

RING 01-204 7525 Anytime.

WE ACCEPT VISA ACCESS: BARCLAYCARD CARD BACKED CHEQUES CASH FOREIGN CURRENCY

DON'T DELAY - PHONE TO-DAY!

WE HAVE SOME SUPERB "HOME-GROWN" SOFTWARE INCLUDING:  
 STOCK CONTROL / INVOICING: (YOU CAN'T INVOICE WHAT YOU HAVEN'T GOT)  
 RANDOM ANALYSIS. PRINT YOUR OWN MONTH/YEAR PLANNER!  
 ALL OUR PROGRAMS CAN BE TAILORED TO MEET INDIVIDUAL REQUIREMENTS.

**L&J COMPUTERS** 01-204 7525  
 3 CRUNDALE AVENUE, KINGSBURY, LONDON, NW9 9PJ

Circle No. 204

# Logic box

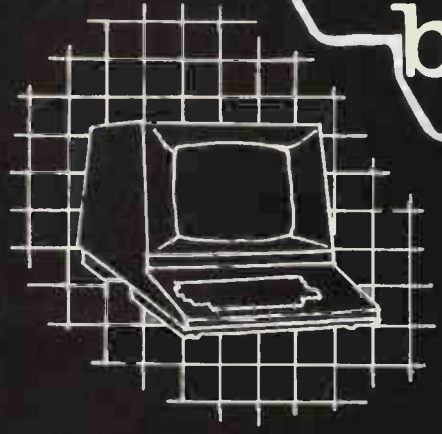

PETs, Compelec, Hewlett-Packard... & software by Caxton Hall...  
 ...in Westminster

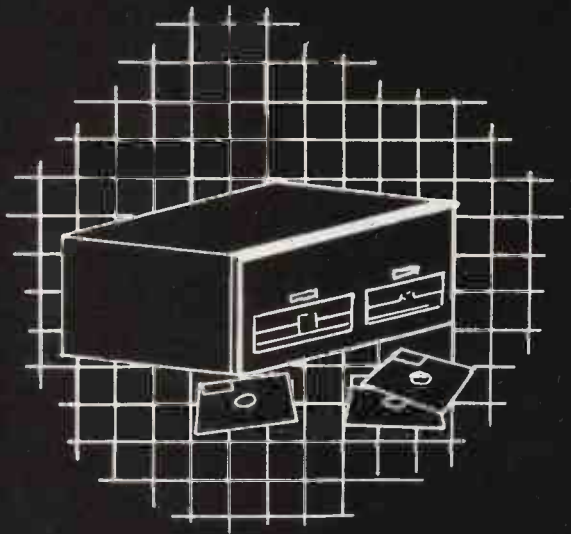

**We have the latest equipment, Petsoft, Petact and business software — as well as Printers, VDUs, Disks, paper and many accessories.**

Call or drop in — we're open from 10 till 6 from Monday to Friday — just by St. James's Park underground.

Logic Box Ltd  
 Planer Bldg.  
 Windmill Rd.,  
 Sunbury, Middx.  
 (09327) 86262

Logic Box Ltd  
 31 Palmer St.,  
 (by Caxton Hall)  
 London, SW1  
 (01) 222 1122

Telex 928 185

• Circle No. 205

(continued from page 121)

```

500 IF(D AND 227)=162 THEN PRINT "LDX";:GOTO 997
510 IF(D AND 227)=160 THEN PRINT "LDY";:GOTO 998
520 IF(D AND 227)=161 THEN PRINT "LDA";:GOTO 1000
530 IF(D AND 227)=66 THEN PRINT "LSR";:GOTO 999
540 IF(D AND 227)=1 THEN PRINT "ORA";:GOTO 1000
550 IF(D AND 227)=34 THEN PRINT "ROL";:GOTO 999
560 IF(D AND 227)=98 THEN PRINT "ROR";:GOTO 999
570 IF(D AND 227) =225 THEN PRINT "SBC";:GOTO 1000
580 IF(D AND 227)=129 THEN PRINT "STA";:GOTO 1000
590 IF(D AND 227)=130 THEN PRINT "STX";:GOTO 997
600 IF(D AND 227)=128 THEN PRINT "STY";:GOTO 1000
610 PRINT "UNDEF";:N=1
620 L=D:GOSUB 2000
630 PRINT
980 A=A+N:NEXT LN
985 GOTO 70
990 GOSUB 2000
991 PRINT:GOTO 980
997 IF(D AND 28)=20 THEN PRINT " Z-PY";:N=2:GOTO 990
998 IF(D AND 28)=0 THEN PRINT " IMM";:N=2:GOTO 990
999 IF(D AND 28)=8 THEN PRINT " ACC";:N=1:GOTO 980
1000 IF(D AND 28)=12 THEN PRINT " ABS";:N=3:GOTO 990
1010 IF(D AND 28)=8 THEN PRINT " IMM";:N=2:GOTO 990
1020 IF(D AND 28)=4 THEN PRINT " Z-PAGE";:N=2:GOTO 990
1030 IF(D AND 28)=0 THEN PRINT " INDX";:N=2:GOTO 990
1040 IF(D AND 28)=16 THEN PRINT " INDY";:N=2:GOTO 990
1050 IF(D AND 28)=20 THEN PRINT " Z-PX";:N=2:GOTO 990
1060 IF(D AND 28)=28 THEN PRINT " ABSX";:N=3:GOTO 990
1070 IF(D AND 28)=24 THEN PRINT " ABSY";:N=3:GOTO 990
1080 PRINT "UNDEF":N=1:GOTO 990
1100 REM RELATIVE ADDR
1105 H=L
1110 IF L >127 THEN H=L-256
1115 L=A+H+N:GOSUB 2000
1120 PRINT H
1130 GOTO 980
2000 REM DEC-HEX
2005 IF N=3 THEN L=L+256*H
2010 Q=INT(L/4096):GOSUB 2500
2020 L=L-Q*4096
2030 Q=INT(L/256):GOSUB 2500
2040 L=L-Q*256
2050 Q=INT(L/16):GOSUB 2500
2060 Q=L-Q*16:GOSUB 2500
2070 PRINT
2080 RETURN
2500 IF Q=10 THEN PRINT "A";:RETURN
2501 IF Q=11 THEN PRINT "B";:RETURN
2502 IF Q=12 THEN PRINT "C";:RETURN
2503 IF Q=13 THEN PRINT "D";:RETURN
2504 IF Q=14 THEN PRINT "E";:RETURN
2505 IF Q=15 THEN PRINT "F";:RETURN
2510 W$=STR$(Q)
2520 PRINT RIGHT$(W$,1);:RETURN

```

(continued from page 121)

respectively — of the histological features being examined. This input data is first checked for validity so that characters 1 or 2 are acceptable and that there is one space present between each block of characters.

The input data is then converted by the program into the same format as the databank by eliminating the spaces. When this validity check has been completed, each one of the first 30 characters in the databank for each powder is compared to the input information and a tally is kept of the number of errors. Note that a 3 in the databank is equivalent to no error, since this allows for the possibility of not observing a feature present in a very small amount.

## Errors stored

If more than five errors are detected, further processing of that powder is stopped to save unnecessary processing time. Where five or fewer characters are in error, the number of errors is stored for later access. When all the powders have been thus examined the powders corresponding to zero errors are output first, followed by those having only one error. Optionally, further output of 2, 3, 4 or 5 errors may be obtained on request.

The program requires 11-12 seconds to READ the DATA when verification of the databank is not required. When verification, using the check digit routine, is deemed necessary this time extends to 3.5 minutes. The time required from entry of the INPUT information to printing-out of the first powder ranges from 179 seconds, for powder No. 1 to, 199 seconds, for powder No. 174, an average time of 3.1 minutes.

For teaching purposes, where a limited databank may be used, a program containing 32 drugs takes about 25 seconds to give an answer from inputting the experimental information.

## Listing 2

```

0240 18 CLC
0241 A9 LDA IMM 5(0005)
0242 05
0243 8D STA ABS 0251
0244 51
0245 02
0246 A9 LDA IMM 10(000A)
0247 0A
0248 6D ADC ABS 0251
0249 51
024A 02
024B 8D STA ABS 0251
024C 51
024D 02
024E 4C JMP (OR RTS=60) F000
024F 00}
0250 FE} or wherever your monitor restarts
0251 - answer (OF)

```

The foregoing is a machine code routine to put 5 in loc 251, then add it to 10 in the accumulator, then put back the answer in 251. Finally jump to monitor, or if a subroutine used by USR function then put in 60(RTS) at loc 24E.

### Listing 3

The sample machine code disassembled by DIS65.

```
OK
RUN
START ADDR? 0240
NO. LINES? 8
0240 GLC
0241 LDA IMM 0005
0243 STA ABS 0251
0246 LDA IMM 000A
0248 ADC ABS 0251
024B STA ABS 0251
024E JMP FE00
0251 UNDEF 000F
```

### Operation of program

1. LOAD PROGRAM The program is loaded either from tape — loading command CLOAD — or disc — loading command LOAD "MICROAID".
2. TYPE RUN
3. TYPE IN CODED OBSERVATIONS, when requested
4. SWITCH ON LINE PRINTER, if hard copy is required.
5. ANSWER any questions which appear on the screen regarding any further printing requirements.
6. ANSWER questions regarding request for another run.

User intervention during a run is limited to answering the questions asked.

### Special preparation

THE POWDER is examined microscopically in the following reagents and the appropriate entry made on the analytical data sheet (see INPUT/OUTPUT).

**Chloral hydrate solution:** Chloral hydrate (50g) dissolved in distilled water (20ml). Used for calcium oxalate, cork, stomata, trichomes, fibres and pollen. The powder should be "boiled in the presence of the mountant to remove unwanted cell content.

**Picric acid solution:** A saturated solution of picric acid in water made by dissolving 1g of picric acid in 95ml of distilled water. Used for protein in the form of aleurone grains or amorphous protein. As many seeds and fruits contain abundant fixed oil, it is advisable to defat the powder by immersion in light petroleum — boiling range 40-60 degrees C for a few minutes before staining. In addition, the background colour can be removed, after staining, by irrigating the mount with water, when the yellow colour given by protein will be clearly visible.

**Phloroglucinol solution:** Phloroglucinol (1g) plus ethanol (95%) to 100ml. This solution is used, in the presence of concentrated hydrochloric acid, for lignified parenchyma, vessels/tracheids and stone cells. If lignified, these structures will acquire a red coloration.

**Iodine water:** Mix one volume of a weak solution of iodine BP16 with a nine volumes of distilled water. Used for starch granules, which yield a characteristic blue-black colour.

The usual format of +/- indicating present/absent is used to record the assessed characters on the data sheet. This information is converted into numerals (- = 1; + = 2) to convert into suitable input data for computer analysis.

### Computer analysis of powdered, organised, vegetable, crude drugs

```
1010 DATA 11111111112111112211111121211253 ACONITE LEAF
1020 DATA 1111111111111111111111111121222180 ACONITE ROOT
1030 DATA 111211211121111112231111121131156 AILANTHUS
1040 DATA 2112111211111111111111111131211160 ALMOND
1050 DATA 2111111121111111111111111111222117 ALSTONIA
1060 DATA 1211111111111111111111111121222188 AMERICAN VERATRUM
1070 DATA 2211111121111111111111111111222115 ANGOSTURA
1080 DATA 1112211211211111122111111121221138 ANISE
1090 DATA 1111112131111111111111111131221169 ARECA
1100 DATA 1111111132111112222121221111220 ARNICA FLOWER
1110 DATA 2111112121111111111111111131222117 ASPIDOSPERMA
1120 DATA 2111111112111112213131321121154 BEARBERRY
1130 DATA 1121211312121111212222221222249 BELLADONNA HERB
1140 DATA 1121211111211112122222231111351 BELLADONNA LEAF
1150 DATA 1121211221111111111111111121122180 BELLADONNA ROOT
1160 DATA 111111111111211212221221111157 BETONY
1170 DATA 2112111121111111111111111111212117 BLACKHAW
1180 DATA 1111111131111111111111111121212180 BLACK HELLEBORE
1190 DATA 2111112122111111111111111121212131 BLACK PEPPER
1200 DATA 1111111111211112221111121121154 BOLDO
1210 DATA 1111111132111112211111121122344 BROOM TOPS
1220 DATA 1111111231111111111111111121212189 BRYONY ROOT
1230 DATA 1112111112111112211111121121152 BUCHU
1240 DATA 11121112111111113121111131222167 CACAO
1250 DATA 2111111211111111111111111121222188 CALUMBA
1260 DATA 111211113111111111111111111232116 CANELLA
1270 DATA 1121211211121111212221221221130 CAPSICUM FRUIT
1280 DATA 11122112112111131111111121221136 CARAWAY
1290 DATA 2111112111111111111111111131212161 CARDAMOM
1300 DATA 211211212111111111111111111222111 CASCARA
1310 DATA 211211121111111121211111111122119 CASCAPILLA
1320 DATA 12112111211111111111111111222111 CASSIA
1330 DATA 1111111111112112222211231111248 CATNEP
1340 DATA 11122112132111112211111121221134 CELERY
1350 DATA 1112111132111112122121221211225 CHAMOMILE
1360 DATA 1111111231111111111111111121121186 CHICORY
1370 DATA 211121112111111111111111111122115 CINCHONA
1380 DATA 121211121111111111111111111222111 CINNAMON
1390 DATA 11121111321111111111111121221226 CLOVES
1400 DATA 2112112111112111111111111121121156 COCA
1410 DATA 211111212111111111111111111222110 COCULLANA
1420 DATA 1111112111111111111111111131212162 COFFEE
1430 DATA 111111111111131111111121112182 COLCHICUM CORM
1440 DATA 111111211111111111111111113112165 COLCHICUM SEED
1450 DATA 11111121221111111111111121211137 COLOCYNTH FRUIT
1460 DATA 111111112111112121111121111253 COLTSFOOT LEAF
1470 DATA 21121112111111111111111111222113 CONDURANGO
```

(continued on next page)

**Diagram 1. Read data.**

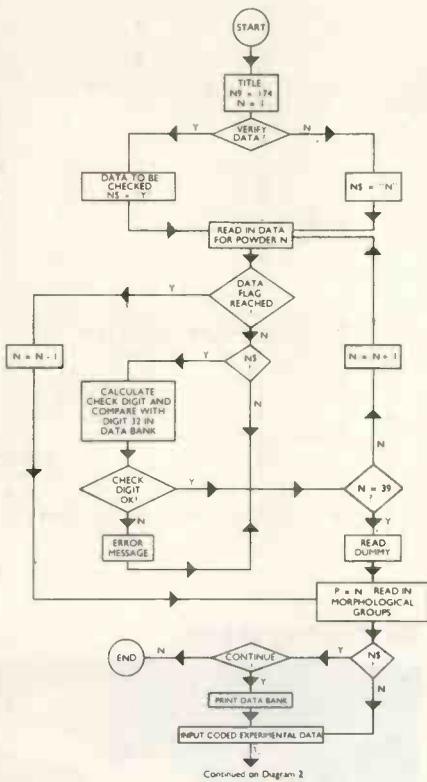

Continued on Diagram 2

**Diagram 2. Input data validation.**

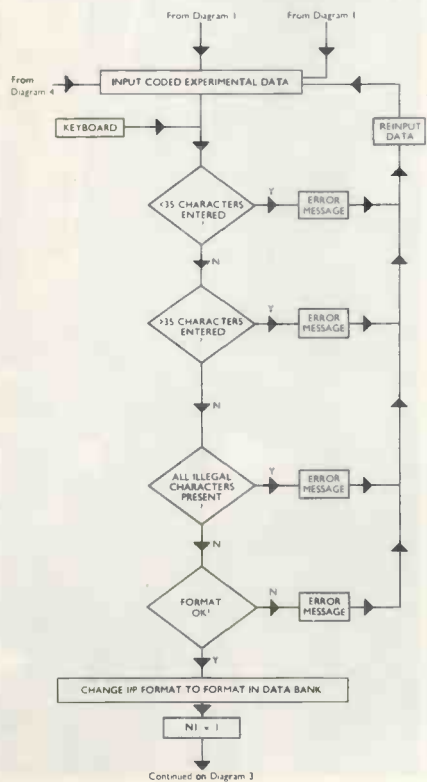

Continued on Diagram 3

(continued from previous page)

1480 DATA 211221121131111111111111111111131231132 CORIANDER FRUIT  
 1490 DATA 111211112111111111111111111111111122117 COTTON ROOT BARK  
 1500 DATA 11111111121111111111111111111121221183 COUCH GRASS  
 1510 DATA 111221121121111111212111111121221137 CUMMIN  
 1520 DATA 111211111211211142213311221121251 DAMIANA  
 1530 DATA 111111121111111121211111211111180 DANDELION ROOT  
 1540 DATA 21222213121211111212222221222246 DATURA INNOXIA HERB  
 1550 DATA 212222131212111112122211221222244 DATURA METEL HERB  
 1560 DATA 211111212211111111111111111121222189 DERRIS  
 1570 DATA 1111111112111112122222221111154 DIGITALIS  
 1580 DATA 111111111211111111112211221111154 DIGITALIS LANATA  
 1590 DATA 1112211212311111111111111121221139 DILL  
 1600 DATA 121111112111111111111111111121222187 DIOSCOREA  
 1610 DATA 112121111112111111112211221111153 DUBOISIA LEAF  
 1620 DATA 212121131212111111112122221222240 EGYPTIAN HENBANE HERB  
 1630 DATA 1111111231111111111111111121121186 ELECAMPAPE  
 1640 DATA 1112111112111112212211221122157 ERIODICTYON  
 1650 DATA 1111111111111111111111111111140 ERGOT  
 1660 DATA 211211112121111111111111111111158 EUCALYPYUS  
 1670 DATA 1111111112111112222213221122245 EUPATORIUM  
 1680 DATA 1112211212311111111111111121121130 FENNEL  
 1690 DATA 11111121111111111111111111111163 FENUGREEK  
 1700 DATA 2112112121111111111111111111122117 FRANGULA  
 1710 DATA 1111111111111111111111111121122186 GALANGAL RHIZOME  
 1720 DATA 211111111111111211111111121211178 GARLIC  
 1730 DATA 211111112211111111111111121222186 GELSEMIUM  
 1740 DATA 1211211121111111111111111121112180 GENTIAN  
 1750 DATA 1111111211111111111111111111122181 GINGER  
 1760 DATA 1112211112111111111111111121112187 GINSENG  
 1770 DATA 11111113121111122211111121113246 GRASS  
 1780 DATA 1112311112211111112211221122245 GRINDELIA  
 1790 DATA 211111112111111111111111121121198 GUAIACUM  
 1800 DATA 111221121131111111111111121121132 HEMLOCK FRUIT  
 1810 DATA 1111111112111111111111111121111156 HEMLOCK LEAF  
 1820 DATA 2122221312121111121222122122245 HENBANE HERB  
 1830 DATA 2113121111121111212221221111351 HENBANE LEAF  
 1840 DATA 111211111211111111111111121111150 HENNA  
 1850 DATA 11121112122111112212121221121240 HOPS  
 1860 DATA 1111111211111111111111111121112189 HORSESADISH  
 1870 DATA 1111111221111111111111111121122170 HYDRASTIS  
 1880 DATA 11121113112111112212221221221140 INDIAN HEMP  
 1890 DATA 111211121111111111111111121222185 INDIAN PODOPHYLLUM  
 1900 DATA 121111122111111111111111121222185 IPECACUANHA  
 1910 DATA 211211112111111111111111121222184 IPOMOEA  
 1920 DATA 1111111211111111111111111111112168 ISPHAGHULA  
 1930 DATA 11121111221111122111111121121150 JABORANDI  
 1940 DATA 211211112111111111111111121212188 JALAP

(continued on next page)

(continued from previous page)

1950 DATA 2111111212111111111111121221135 JUNIPER BERRIES  
 1960 DATA 211211111321111112212122221111229 KOUSSO  
 1970 DATA 21111111133111311222222221111227 LAVENDER  
 1980 DATA 2211111111111112111111121122245 LILY OF THE VALLEY HERB  
 1990 DATA 1111111211111111111111131211167 LINSEED  
 2000 DATA 2111112122111111111111121122180 LIQUORICE  
 2010 DATA 1111111312211111221111121222246 LOBELIA  
 2020 DATA 2111111112111111111111121122193 LOGWOOD  
 2030 DATA 2111112122111111111111121222189 LONCHOCARPUS  
 2040 DATA 21111121132311112122212221123244 LUCERNE  
 2050 DATA 1111111111111111111111121211166 MACE  
 2060 DATA 1111111111111111111111121122186 MALE FERN  
 2070 DATA 21121111132111112122121221211234 MARGOLD  
 2080 DATA 1112111112111111111111121122187 MARSHMALLOW  
 2090 DATA 3112111112211111221111121221155 MATE  
 2100 DATA 111211111321111122121221211226 MATRICARIA  
 2110 DATA 1111112111111111111111131211167 MUSTARD  
 2120 DATA 1111112111111111111111131112165 NUTMEG  
 2130 DATA 111111211111112211111111311163 NUX VOMICA  
 2140 DATA 21121121221111111111111222119 OAK  
 2150 DATA 2111112111211111111111121121152 ORANGE LEAF  
 2160 DATA 2111111311111111111111121112187 ORRIS  
 2170 DATA 1111111221111111111111121222187 PAREIRA  
 2180 DATA 1111111211111111111111121221184 PELLITORY  
 2190 DATA 11111111211121122222221122241 PEPPERMINT  
 2200 DATA 1211111112111111111111121111154 PHYTOLACCA LEAF  
 2210 DATA 2112112112111112211111121222139 PIMENTO  
 2220 DATA 1111111121111111111111121112198 PINE  
 2230 DATA 1112111121111111111111121222185 PODOPHYLLUM  
 2240 DATA 12111111231111111111111122185 POKE ROOT  
 2250 DATA 31121111211111111111111212116 POMEGRANATE  
 2260 DATA 1111111112111111111111111225 POPPY PETAL  
 2270 DATA 2112111113211111222212122121222 PYRETHRUM  
 2280 DATA 2111111132111111111111121122191 QUASSIA  
 2290 DATA 21111111311111111111111222118 QUILLAIA  
 2300 DATA 11121111122111112213311321121255 RASPBERRY LEAF  
 2310 DATA 2111111122111111111111121122189 RAUWOLFIA SERPENTINA  
 2320 DATA 2111111122111111111111121222186 RAUWOLFIA VOMITORIA  
 2330 DATA 1112111111111112211111121111227 RED-ROSE PETAL  
 2340 DATA 2111111121111111111111121122193 RED SANDERS  
 2350 DATA 2111112121111111111111121122182 RHATANY  
 2360 DATA 111211113111111111111112112181 RHUBARB  
 2370 DATA 1112111112111111111111121111150 RUE  
 2380 DATA 11111111311111221111121121225 SAFFRON  
 2390 DATA 11111111111121121222221211150 SAGE  
 2400 DATA 12111111111111221111121112182 SALEP  
 2410 DATA 2111111112111111111111121122193 SANDAL WOOD

(continued on next page)

Diagram 3. Data processing.

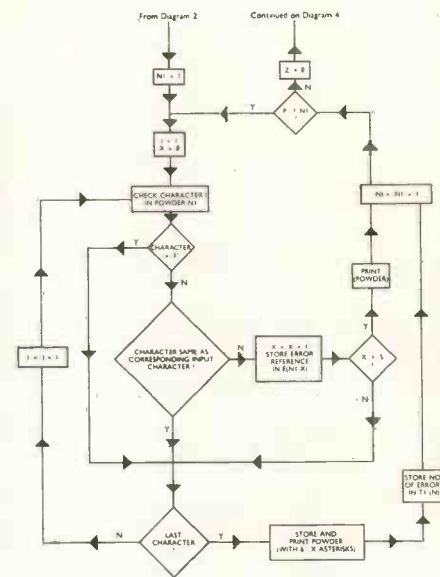

Dr Geoffrey Jolliffe.



(continued from previous page)

```

2420 DATA 11121111132111112212121221211226 SANTONICA
2430 DATA 211111111211111111111111121122193 SAPPAN
2440 DATA 121111111211111111111111121332181 SASSAPARILLA
2450 DATA 1211211122111111111111111222116 SASSAFRAS BARK
2460 DATA 111111112111111111111111121122194 SASSAFRAS WOOD
2470 DATA 211121111211111121111111121121144 SAVIN TOPS
2480 DATA 1111111223111112211111121211187 SENEGA
2490 DATA 2112112211231111221111121221137 SENNA FRUIT
2500 DATA 21121121111121112211111121121150 SENNA LEAF
2510 DATA 1111111211111111111111121322188 SERPENTARY
2520 DATA 2111111121111111111111111221112 SIMARUBA
2530 DATA 211111213111111111111111122112 SLIPPERY ELM
2540 DATA 2111112111111111111111131213166 SOY BEAN
2550 DATA 1211111112111111111111121112172 SQUILL
2560 DATA 2111111213211111111111121231133 STAR ANISE
2570 DATA 111111211111111111111112111162 STAVESACRE
2580 DATA 21222213121211112122211221222244 STRAMONIUM HERB
2590 DATA 31121211111211112122211221111350 STRAMONIUM LEAF
2600 DATA 311211121111111122111113131162 STROPHANTHUS
2610 DATA 21121131311111111111121122188 SWEET FLAG
2620 DATA 111211111111112211111121221155 TEA
2630 DATA 112121111112111121222222112151 TOBACCO
2640 DATA 111111121211111221111131112181 TURMERIC
2650 DATA 111211112311111111111121222181 TURPETH
2660 DATA 11111111211111221111121222187 VALERIAN
2670 DATA 2211111212211111221111121221134 VANILLA
2680 DATA 111211112111111111111111112111 Wahoo
2690 DATA 12111111111111111111121222188 WHITE HELLEBORE
2700 DATA 2112111121111111111111131222110 WILD CHERRY
2710 DATA 211111212111111111111131223112 WITCH-HAZEL BARK
2720 DATA 2112112112112111212111121221154 WITCH-HAZEL LEAF
2730 DATA 111111111211111212212122111151 XANTHIUM
2740 DATA 111111121111111221111121122181 ZEDARY
3000 DATA*
3010 DATA BARK, FLOWER, FRUIT, HERB, LEAF, SEED, UNDERGROUND LEAF,
        UNDERGROUND ROOT/STEM, WOOD
    
```



Dr Georgina Jolliffe.

Diagram 4. Output information.

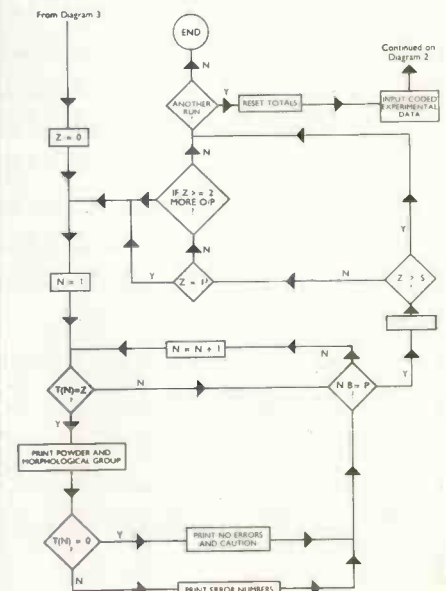

```

9000 'ROUTINE TO CALCULATE CHECK DIGITS
9010 N=1:PRINT"ENTER 31 DIGITS":INPUTB$(N)
9020 IFLEN(B$(N))<31PRINTLEN(B$(N));"DIGITS ENTERED":GOTO9010
9030 GOSUB9060
9040 PRINT:PRINT"CHECK DIGIT = ";RIGHT$(T$,1)
9050 PRINT:PRINT:PRINT:GOTO9010
9060 S=0:FORI=1TO31:S=VAL(MID$(B$(N),I,1))*I+S:NEXTI
9070 S$=STR$(S):T=0
9080 FORI=1TO3:T=VAL(MID$(S$,I+1,1))*(I+6)+T:NEXTI
9090 T$=STR$(T):RETURN
    
```

1	11111	11111	21111	12211	11112	12112	ACONITE LEAF (LEAF)
2	11111	11111	11111	11111	11112	12221	ACONITE ROOT (UNDERGROUND ROOT/STEM)
3	11121	12111	21111	12231	11112	11311	AILANTHUS (LEAF)
4	21121	11211	11111	11111	11112	12111	ALMOND (SEED)
5	21111	11121	11111	11111	11111	12221	ALSTONIA (BARK)
6	12111	11111	11111	11111	11112	12221	AMERICAN VERATRUM (UNDERGROUND ROOT/STEM)
7	22111	11121	11111	11111	11111	12221	ANGOSTURA (BARK)
8	11122	11211	21111	12211	11112	12211	ANISE (FRUIT)
9	11111	11213	11111	11111	11113	12211	ARECA (SEED)
10	11111	11113	21111	12222	12122	11112	ARNICA FLOWER (FLOWER)
11	21111	12121	11111	11111	11113	12221	ASPIDOSPERMA (BARK)
12	21111	11111	21111	12213	13132	11211	BARBERRY (LEAF)
13	11212	11312	12111	12122	22222	12222	BELLADONNA HERB (HERB)
14	11212	11111	12111	12122	22222	11113	BELLADONNA LEAF (LEAF)
15	11212	11122	11111	11111	11112	11221	BELLADONNA ROOT (UNDERGROUND ROOT/STEM)
16	11111	11111	11121	12122	21122	11111	BETONY (LEAF)
17	21121	11121	11111	11111	11111	12121	BLACKHAW (BARK)
18	11111	11113	11111	11111	11112	12121	BLACK HELLEBORE (UNDERGROUND ROOT/STEM)
19	21111	11212	21111	11111	11112	12121	BLACK PEPPER (FRUIT)
20	11111	11111	12111	12221	11112	11211	BOLDO (LEAF)
21	11111	11113	21111	12211	11112	11223	BROOM TOPS (HERB)
22	11111	11123	11111	11111	11112	12121	BRYONY ROOT (UNDERGROUND ROOT/STEM)
23	11121	11111	21111	12211	11112	11211	BUCHU (LEAF)
24	11121	11211	11111	12121	11113	12221	CACAO (SEED)
25	21111	11121	11111	11111	11112	12221	CALUMBA (UNDERGROUND ROOT/STEM)
26	11121	11131	11111	11111	11111	12321	CANELLA (BARK)
27	11212	11211	12111	12122	21122	12211	CAPSICUM FRUIT (FRUIT)
28	11122	11211	21111	31111	11112	12211	CARAWAY (FRUIT)
29	21111	11211	11111	11111	11113	12121	CARDAMOM (SEED)
30	21121	12121	11111	11111	11111	12221	CASCARA (BARK)
31	21121	11121	11111	12121	11111	11221	CASCARILLA (BARK)
32	12112	11121	11111	11111	11111	12221	CASSIA (BARK)
33	11111	11111	11121	12222	21122	11112	CATNEP (HERB)
34	11122	11213	21111	12211	11112	12211	CELERY (FRUIT)
35	11121	11113	21111	12122	12122	12112	CHAMOMILE (FLOWER)
36	11111	11123	11111	11111	11112	11211	CHICORY (UNDERGROUND ROOT/STEM)
37	21112	11121	11111	11111	11111	11221	CINCHONA (BARK)
38	12112	11121	11111	11111	11111	12221	CINNAMON (BARK)
39	11121	11113	21111	11111	11112	12212	CLOVES (FLOWER)
40	21121	12111	11211	11111	11112	11211	COCA (LEAF)
41	21111	12121	11111	11111	11111	12221	COCILLANA (BARK)
42	11111	11211	11111	11111	11113	12121	COFFEE (SEED)
43	11111	11111	11111	31111	11112	11121	COLCHICUM CORM (UNDERGROUND ROOT/STEM)
44	11111	11211	11111	11111	11113	11121	COLCHICUM SEED (SEED)
45	11111	11212	21111	11111	11112	12111	COLOCYNTH FRUIT (FRUIT)

(continued on next page)



(continued from previous page)

46	11111	11111	21111	12121	11112	11112	COLTSFOOT LEAF (LEAF)
47	21121	11121	11111	11111	11111	12221	CONDURANGU (BARK)
48	21122	11211	31111	11111	11113	12311	CORIANDER FRUIT (FRUIT)
49	11121	11121	11111	11111	11111	11221	COTTON ROOT BARK (BARK)
50	11111	11112	11111	11111	11112	12211	COUCH GRASS (UNDERGROUND ROOT/STEM)
51	11122	11211	21111	12121	11112	12211	CUMMIN (FRUIT)
52	11121	11112	11211	12213	31122	11212	DAMIANA (LEAF)
53	11111	11121	11111	12121	11112	11111	DANDELION ROOT (UNDERGROUND ROOT/STEM)
54	21222	21312	12111	12122	22222	12222	DATURA INNOXIA HERB (HERB)
55	21222	21312	12111	12122	21122	12222	DATURA METEL HERB (HERB)
56	21111	12122	11111	11111	11112	12221	DERRIS (UNDERGROUND ROOT/STEM)
57	11111	11111	21111	12122	22222	11111	DIGITALIS (LEAF)
58	11111	11111	21111	11112	21122	11111	DIGITALIS LANATA (LEAF)
59	11122	11212	31111	11111	11112	12211	DILL (FRUIT)
60	12111	11121	11111	11111	11112	12221	DIOSCOREA (UNDERGROUND ROOT/STEM)
61	11212	11111	12111	11112	21122	11111	DUBOISIA LEAF (LEAF)
62	21212	11312	12111	11112	12222	12222	EGYPTIAN HENBANE HERB (HERB)
63	11111	11123	11111	11111	11112	11211	ELECAMPANE (UNDERGROUND ROOT/STEM)
64	11121	11111	21111	12212	21122	11221	ERIODICTYON (LEAF)
65	11111	11111	11111	11111	11111	11111	ERGOT (HERB)
66	21121	11121	21111	11111	11112	11111	EUCALYPYUS (LEAF)
67	11111	11111	21111	12222	21322	11222	EUPATORIUM (HERB)
68	11122	11212	31111	11111	11112	11211	FENNEL (FRUIT)
69	11111	11211	11111	11111	11111	11111	FENUGREEK (SEED)
70	21121	12121	11111	11111	11111	11321	FRANGULA (BARK)
71	11111	11111	11111	11111	11112	11221	GALANGAL RHIZOME (UNDERGROUND ROOT/STEM)
72	21111	11111	11111	21111	11112	12111	GARLIC (UNDERGROUND LEAF)
73	21111	11122	11111	11111	11112	12221	GELSEMIUM (UNDERGROUND ROOT/STEM)
74	12112	11121	11111	11111	11112	11121	GENTIAN (UNDERGROUND ROOT/STEM)
75	11111	11121	11111	11111	11111	21221	GINGER (UNDERGROUND ROOT/STEM)
76	11122	11112	11111	11111	11112	11121	GINSENG (UNDERGROUND ROOT/STEM)
77	11111	11312	11111	22211	11112	11132	GRASS (HERB)
78	11123	11112	21111	11112	21122	11222	GRINDELIA (HERB)
79	21111	11112	11111	11111	11112	11211	GUAIACUM (WOOD)
80	11122	11211	31111	11111	11112	11311	HEMLOCK FRUIT (FRUIT)
81	11111	11111	21111	11111	11112	11111	HEMLOCK LEAF (LEAF)
82	21222	21312	12111	12122	22122	12222	HENBANE HERB (HERB)
83	21131	21111	12111	12122	22122	11113	HENBANE LEAF (LEAF)
84	11121	11111	21111	11111	11112	11111	HENNA (LEAF)
85	11121	11212	21111	12212	12122	11212	HOPS (HERB)
86	11111	11121	11111	11111	11112	11121	HORSESADISH (UNDERGROUND ROOT/STEM)
87	11111	11122	11111	11111	11112	11221	HYDRASTIS (UNDERGROUND LEAF)
88	11121	11311	21111	12212	22122	12211	INDIAN HEMP (HERB)
89	11121	11121	11111	11111	11112	12221	INDIAN PODOPHYLLUM (UNDERGROUND ROOT/STEM)

(continued on next page)

(continued from previous page)

90	12111	11122	11111	11111	11112	12221	IPECACUANHA (UNDERGROUND ROOT/STEM)
91	21121	11121	11111	11111	11112	12221	IPOMOEA (UNDERGROUND ROOT/STEM)
92	11111	11211	11111	11111	11111	11121	ISPHAGHULA (SEED)
93	11121	11112	21111	12211	11112	11211	JABORANDI (LEAF)
94	21121	11121	11111	11111	11112	12121	JALAP (UNDERGROUND ROOT/STEM)
95	21111	11212	11111	11111	11112	12211	JUNIPER BERRIES (FRUIT)
96	21121	11113	21111	12212	12222	11112	KOUSSO (FLOWER)
97	21111	11113	31131	12222	22222	11112	LAVENDER (FLOWER)
98	22111	11111	11111	21111	11112	11222	LILY OF THE VALLEY HERB (HERB)
99	11111	11211	11111	11111	11113	12111	LINSEED (SEED)
100	21111	12122	11111	11111	11112	11221	LIQUORICE (UNDERGROUND ROOT/STEM)
101	11111	11312	21111	12211	11112	12222	LOBELIA (HERB)
102	21111	11112	11111	11111	11112	11221	LOGWOOD (WOOD)
103	21111	12122	11111	11111	11112	12221	LONCHOCARPUS (UNDERGROUND ROOT/STEM)
104	21111	12113	23111	12122	21222	11232	LUCERNE (HERB)
105	11111	11111	11111	11111	11112	12111	MACE (SEED)
106	11111	11111	11111	11111	11112	11221	MALE FERN (UNDERGROUND ROOT/STEM)
107	21121	11113	21111	12122	12122	12112	MARIGOLD (FLOWER)
108	11121	11112	11111	11111	11112	11221	MARSHMALLOW (UNDERGROUND ROOT/STEM)
109	31121	11112	21111	12211	11112	12211	MATE (LEAF)
110	11121	11113	21111	12212	12122	12112	MATRICARIA (FLOWER)
111	11111	11211	11111	11111	11113	12111	MUSTARD (SEED)
112	11111	11211	11111	11111	11113	11121	NUTMEG (SEED)
113	11111	11211	11111	12211	11111	13111	NUX VOMICA (SEED)
114	21121	12122	11111	11111	11111	12221	OAK (BARK)
115	21111	12111	21111	11111	11112	11211	ORANGE LEAF (LEAF)
116	21111	11131	11111	11111	11112	11121	ORRIS (UNDERGROUND ROOT/STEM)
117	11111	11122	11111	11111	11112	12221	PARAIRA (UNDERGROUND ROOT/STEM)
118	11111	11121	11111	11111	11112	12211	PELLITORY (UNDERGROUND ROOT/STEM)
119	11111	11112	11121	12222	22222	11222	PEPPERMINT (HERB)
120	12111	11111	21111	11111	11112	11111	PHYTOLACCA LEAF (LEAF)
121	21121	11211	21111	12211	11112	12221	PIMENTO (FRUIT)
122	11111	11112	11111	11111	11112	11121	PINE (WOOD)
123	11121	11121	11111	11111	11112	12221	PODOPHYLLUM (UNDERGROUND ROOT/STEM)
124	12111	11123	11111	11111	11111	11221	POKE ROOT (UNDERGROUND ROOT/STEM)
125	31121	11121	11111	11111	11111	12121	POMEGRANATE (BARK)
126	11111	11111	21111	11111	11111	11112	POPPY PETAL (FLOWER)
127	21121	11113	21111	12222	12122	12112	PYRETHRUM (FLOWER)
128	21111	11132	11111	11111	11112	11221	QUASSIA (WOOD)
129	21111	11131	11111	11111	11111	12221	QUILLAIRA (BARK)
130	11121	11112	21111	12213	31132	11212	RASPBERRY LEAF (LEAF)
131	21111	11122	11111	11111	11112	11221	RAUNOLFIA SERPENTINA (UNDERGROUND ROOT/STEM)
132	21111	11122	11111	11111	11112	12221	RAUNOLFIA VOMITORIA (UNDERGROUND ROOT/STEM)
133	11121	11111	11111	12211	11112	11112	RED-ROSE PETAL (FLOWER)

(continued on next page)

(continued from previous page)

134	21111	11112	11111	11111	11112	11221	RED SANDERS (WOOD)
135	21111	12121	11111	11111	11112	11221	RHATANY (UNDERGROUND ROOT/STEM)
136	11121	11131	11111	11111	11111	21121	RHUBARB (UNDERGROUND ROOT/STEM)
137	11121	11111	21111	11111	11112	11111	RUE (LEAF)
138	11111	11113	11111	12211	11112	11212	SAFFRON (FLOWER)
139	11111	11111	11121	12122	22221	21111	SAGE (LEAF)
140	12111	11111	11111	12211	11112	11121	SALEP (UNDERGROUND ROOT/STEM)
141	21111	11112	11111	11111	11112	11221	SANDAL WOOD (WOOD)
142	11121	11113	21111	12212	12122	12112	SANTONICA (FLOWER)
143	21111	11112	11111	11111	11112	11221	SAPPAN (WOOD)
144	12111	11112	11111	11111	11112	13321	SARSAPARILLA (UNDERGROUND ROOT/STEM)
145	12112	11122	11111	11111	11111	12221	SASSAFRAS BARK (BARK)
146	11111	11112	11111	11111	11112	11221	SASSAFRAS WOOD (WOOD)
147	21112	11112	11111	21111	11112	11211	SAVIN TOPS (HERB)
148	11111	11122	31111	12211	11112	12111	SENEGA (UNDERGROUND ROOT/STEM)
149	21121	12211	23111	12211	11112	12211	SENNA FRUIT (FRUIT)
150	21121	12111	11211	12211	11112	11211	SENNA LEAF (LEAF)
151	11111	11121	11111	11111	11112	13221	SERPENTARY (UNDERGROUND ROOT/STEM)
152	21111	11121	11111	11111	11111	12211	SIMARUBA (BARK)
153	21111	12131	11111	11111	11111	11221	SLIPPERY ELM (BARK)
154	21111	11211	11111	11111	11113	12131	SOY BEAN (SEED)
155	12111	11111	21111	11111	11112	11121	SQUILL (UNDERGROUND LEAF)
156	21111	11213	21111	11111	11112	12311	STAR ANISE (FRUIT)
157	11111	11211	11111	11111	11112	11111	STAVESACRE (SEED)
158	21222	21312	12111	12122	21122	12222	STRAMONIUM HERB (HERB)
159	31121	21111	12111	12122	21122	11113	STRAMONIUM LEAF (LEAF)
160	31121	11211	11111	12211	11113	13111	STROPHANTHUS (SEED)
161	21121	13131	11111	11111	11112	11221	SWEET FLAG (UNDERGROUND ROOT/STEM)
162	11121	11111	11112	12211	11112	12211	TEA (LEAF)
163	11212	11111	12111	12122	22222	11211	TOBACCO (LEAF)
164	11111	11121	21111	12211	11113	11121	TURMERIC (UNDERGROUND ROOT/STEM)
165	11121	11123	11111	11111	11112	12221	TURPETH (UNDERGROUND ROOT/STEM)
166	11111	11112	11111	12211	11112	12221	VALERIAN (UNDERGROUND ROOT/STEM)
167	22111	11212	21111	12211	11112	12211	VANILLA (FRUIT)
168	11121	11121	11111	11111	11111	11121	WAHOO (BARK)
169	12111	11111	11111	11111	11112	12221	WHITE HELLEBORE (UNDERGROUND ROOT/STEM)
170	21121	11121	11111	11111	11113	12221	WILD CHERRY (BARK)
171	21111	12121	11111	11111	11113	12231	WITCH-HAZEL BARK (BARK)
172	21121	12112	11211	12121	11112	12211	WITCH-HAZEL LEAF (LEAF)
173	11111	11111	21111	12122	12122	11111	XANTHIUM (LEAF)
174	11111	11121	11111	12211	11112	11221	ZEDOARY (UNDERGROUND ROOT/STEM)

```

10 CLS:PRINT#466:"MICROID" EDN 05/06/79:"CLEAR590:DEFINT A-Z
15 D=1:REM TO LIST UPWARDS FROM A PARTICULAR POWDER NO. CHANGE D ACCORDINGLY (USEFUL IF A DATA BANK LISTING IS FAULTY)
20 Z:=CHR$(28)+CHR$(31)+CHR$(23):Z9=14312
30 DIM B$(174):E(174,6):T(174):N9=174:DIM STATEMENTS HERE
40 PRINT#4:STRING$(33,61)"MICROID POWDER IDENTIFICATION"STRING$(33,61)
45 N=1:PRINT"DO YOU WANT TO VERIFY DATA BANK?";
50 N$=INKEY$:IF N$="N" THEN GOTO ELSEIF N$="Y" THEN GOTO ELSE50
55 PRINT#4,"DATA BANK INFORMATION IS BEING CHECKED FOR ACCURACY"
60 READ B$(N)
70 IF B$(N)="" THEN N=N+1:GOTO 95
75 IF N$="Y" THEN PRINT#972:"VERIFYING":ELSEIF N$="N" THEN PRINT#976:"READING"
80 PRINT#4 POWDER NO.":N:IF N$="Y" THEN GOTO 90
85 IF N=9 READ B$:GOTO 95
90 N=N+1:GOTO 60
95 P=N:FOR I=1 TO 8 READ B$(I):NEXT I:PRINT:IF N$="Y" THEN PRINT"SWITCH ON PRINTER FOR DATA BANK LISTING":INPUT"PRESS ENTER TO CONTINUE":B$ GOS
UB910
100 PRINT#4:P,"POWDERS ARE IN THIS PROGRAM":,"ENTER -1,1 FOR CHARACTER ABSENT",,"2 FOR CHARACTER PRESENT"
110 PRINT#4,"YOU MUST TYPE IN SIX BLOCKS OF FIVE DIGITS (SEPARATED BY SINGLESPACE) ON ONE LINE":PRINT#4:" "
120 INPUT#4
130 IF LEN(P#) < 35 PRINT#4"YOU HAVE NOT ENTERED ENOUGH DATA":GOTO 130
135 IF LEN(P#) > 35 PRINT#4"YOU HAVE ENTERED TOO MUCH DATA":GOTO 130
140 FOR I=1 TO 35
150 IF MID$(P#,I,1)="" THEN GOTO 200
160 IF MID$(P#,I,1)="" THEN GOTO 200
170 IF MID$(P#,I,1)="" THEN GOTO 200
180 PRINT#4"YOU HAVE ENTERED A ";MID$(P#,I,1):" AND THIS IS NOT ALLOWED";
190 PRINT#4" - RE-INPUT DATA":FOR O=1 TO 1000:NEXT O:GOTO 100
200 NEXT I
210 FOR I=6 TO 38 STEP 6
220 IF MID$(P#,I,1) < "O" THEN PRINT#4"INCORRECTLY FORMED DATA BLOCKS":GOTO 190
230 NEXT I
240 D$=MID$(P#,1,5)+MID$(P#,7,5)+MID$(P#,13,5)+MID$(P#,19,5)+MID$(P#,25,5)+MID$(P#,31,5)
250 X=0:NL=1:PRINT#4:" THE MORE ASTERISKS THE BETTER THE AGREEMENT BETWEEN INPUT DATA AND THE DATA BANK:,,,***** = NO ERRORS ",
295 PRINT#4" ***** = 1 ERROR",," **** = 2 ERRORS",," *** = 3 ERRORS",," ** = 4 ERRORS",," * = 5 ERRORS",," ( ) = 6 ERRORS
"PRINT#4"SWITCH ON PRINTER FOR HARD COPY":PRINT
300 FOR I=1 TO 38
310 IF MID$(B$(NL),I,1)="" THEN GOTO 350
320 IF MID$(B$(NL),I,1) < MID$(D$,I,1) THEN X=X+1:E(NL,X)=1
330 IF O$PRINT#996:CHR$(38):NL:TAB(7):" (";MID$(B$(NL),34,25);")":T(NL)=6:GOTO 330
350 NEXT I
360 PRINT#832:STRING$(6-X,42):TAB(7):MID$(B$(NL),34,25):CHR$(38):PRINT:PRINT
370 T(NL)=X
380 NL=NL+1
390 X=X+1
400 IF P# < NL THEN GOTO 300
450 PRINT:PRINT#4"RESULTS ARE ABOUT TO BE LISTED":PRINT#4:Z=0
460 C$="" NO ERRORS ***** COMPARE YOUR POWDER WITH AN AUTHENTIC SAMPLE *****"
470 IF PEEK(29) < 200 PRINT#4"INPUT DATA: ";P#:CHR$(10):CHR$(10):"REF"
480 FOR N=1 TO P
490 IFT(N)=2 LET B$=MID$(B$(N),33,25)*" (";M$(VAL(MID$(B$(N),31,1)))>)*"
510 IFT(N)=2 PRINT#4:IF PEEK(29) < 200 PRINT#4:TAB(6):B$
515 IFT(N) < 2 THEN GOTO 570
520 IFT(N)=0 PRINT#4:IF PEEK(29) < 200 PRINT#4:5):C$:CHR$(10):CHR$(10)
521 IFT(N)=0 THEN GOTO 570
525 PRINT#4(N):"ERROR(S) -";:IF PEEK(29) < 200 PRINT#4:8):T(N):"ERROR":IFT(N) < 1 PRINT#4"5 -";:ELSE PRINT#4" -";
530 FOR X=1 TO 5
540 IF E(N,X) > 0 PRINT#4(N,X):IF PEEK(29) < 200 PRINT#4(N,X);
550 NEXT X
560 PRINT:IF PEEK(29) < 200 PRINT#4:CHR$(10):CHR$(10)
570 NEXT N
580 Z=Z+1
585 IF Z > 5 THEN GOTO 620
590 IF Z=2 PRINT#960:"DO YOU WANT O/P FOR";Z:"ERRORS?":ELSE GOTO 610
600 N$=INKEY$:IF N$="Y" THEN GOTO 610 ELSEIF N$="N" THEN GOTO 620 ELSE GOTO 600
610 PRINT#960:CHR$(38):"LOOKING FOR";Z:"ERROR(S)":GOTO 490
620 PRINT#960:CHR$(38):"DO YOU WANT ANOTHER RUN?";
630 N$=INKEY$:IF N$="Y" THEN GOTO 600 ELSEIF N$="N" THEN GOTO 640 ELSE GOTO 630
640 PRINT#4:PRINT#466:"G O O D B Y E"
650 PRINT#896:END
800 "DATA VERIFICATION
810 GOSUB 900
860 IF MID$(B$(N),32,1) < ORIGHT$(T$(1)) THEN PRINT#4" CHECK ";MID$(B$(N),33,25):" DATA":PRINT
870 RETURN
900 PRINT#960:CHR$(10):"PLEASE WAIT A FEW SECONDS...":FOR N=1 TO P:T(N)=0:FOR X=1 TO 5:E(N,X)=0:NEXT X,N:GOTO 100
910 IF PEEK(29) < 200 PRINT#4:"LISTING -";:CHR$(10):CHR$(10):ELSE RETURN
915 FOR N=0 TO 9
920 LPRINT#4:TAB(5):MID$(B$(N),1,5):" ";MID$(B$(N),6,5):" ";MID$(B$(N),11,5):" ";MID$(B$(N),16,5):" ";MID$(B$(N),21,5):" ";MID$(B$(N),
26,5):" ";MID$(B$(N),31,5):" (";M$(VAL(MID$(B$(N),31,1)))>)*"
925 PRINT#4:TAB(5):MID$(B$(N),34,25):NEXT N
930 RETURN

```

# "My best Apple programs are on long-term deposit in the City... it pays rather well!"

We brought the first five Apples into the U.K. in November '77, with every penny we had. In November '79, we find several thousand throughout the country.

**THANK YOU** Apple owners.

Now we'd like to help you re-coup your investment by cataloguing and supporting the best Apple programs in the U.K. The Apple Software Bank is more like an old penny bank than a major clearing bank, but we know you'll help it grow. Telephone Stephen Derrick on 01-626-8121 to discuss your investment.

**ATTENTION ALL** Estate Agents, Employment Agencies, Yacht Brokers, Antique Dealers and Motor Traders.

Find out about **FINDER SOFTWARE!**

## **SOME BLUE CHIPS**

**TESKIM.** This ROM will simulate the Tektronix 4010 family of graphics terminals. It's rather good!

**UPPER LOWER CASE ADAPTOR** A chip for the chap considering word processing.

## **NEW ISSUES**

We are continually trying to bring the latest add-ons for your Apples. Please phone for the latest product information and data sheets.

## **NEW PRODUCTS**

**8" SHUGART DISKS** giving 1.2 Megabytes A twin drive (with room for a third.) disk system with controller and software, give tremendous commercial possibilities. £2350 Excl. V.A.T.

**WORD PROCESSOR.** Ask about our Apple II Plus word processor package. Complete System with Diablo 1650 Daisy-Wheel Printer. £4250 Excl. V.A.T.

**PERSONAL COMPUTER PRINTERS.** Sensational 40 & 80 Character printer (graphics options) from £243 Excl. V.A.T. Interfaces for Apple, Pet & TRS 80. High quality silent printers. It's your choice!

**A/D BOARD** At last we have either an 8 bit or 12 bit A/D card for Apple. Excellent spec from £125 Excl. V.A.T.

**APPLE PASCAL** £296



# Personal Computers Limited

194-200 Bishopsgate, London EC2M 4NR.

Let us advise you about **COLOUR DISPLAY** on your Apple. Contact Technical Services



● Circle No. 206

# EUROC

## -Simplicity is the watchword



EUROC is a new, simple to use, fast, powerful micro-computer system for business. It's British, the program tried and tested.

EUROC is already being talked about by bankers, accountants and businessmen. See it on Stand 642 at the International Business Show at the National Exhibition Centre, Birmingham from 23rd October to 1st November, 1979.

EUROC hardware is manufactured exclusively for Euro-Calc Ltd., by Plessey Microsystems Ltd. EUROC will be on permanent display at Euro-Calc's branches at 55, High Holborn, London WC1 and at 224, Tottenham Court Road, London W1.

EUROC looks after your day books (Cash-Sales-Purchase & Nominal).

EUROC keeps your ledgers (Sales-Purchases & Nominal).

EUROC prints out your Statements and Remittance advices.

EUROC produces 8 vital REPORTS at your month end and to ensure you enjoy complete financial control. (I.E. Aged Debtors Report, Aged Creditors Report, Name and Address Report, Sales Analysis Report, VAT Report, Profit and Loss Report, Assets and Liabilities Report, Funds Report).

In addition optional Stock Control and Payroll programs will be available.

There are no hidden extras. EUROC's price of £7,995 ex. VAT includes—Hardware, Software, Initial Supply of Stationery and Binders—in fact everything you need to computerise your business including the 1st year's Maintenance Contract—nationwide service is undertaken by Plessey Microsystems Ltd.

For further information and trade-distribution enquiries, talk to Peter Ingoldby, Managing Director, Euro-Calc Ltd., 55, High Holborn, London, W.C.1., telephone 01-405 3223 or Anthony Manton, Sales Director at Tottenham Court Road on 01-636 5560.

# EUROC

● Circle No. 207

PRACTICAL COMPUTING November 1979

# Practical Computing Back Issues

If you are interested in microcomputers you will want to read the *Practical Computing* reviews of the machines in which you are interested. Each month *Practical Computing* carries at least one hands-on test of a popular microcomputer for use in business, the home, schools and colleges. Each review contains the kind of information you need - technical data and unbiased critical comment on the strengths and weaknesses of each system.

Each issue is packed with essential reading on microcomputers, including all our regular monthly features: Book and cassette reviews; Glossary of computer terminology; Computabits; Pet Corner (February onwards); Apple Pie (May onwards); Tandy Forum (March onwards); serialised *Illustrating Basic* (October 1978 onwards).

All this makes *Practical Computing* the invaluable source for the whys, wherefores, hows, ifs and buts of microcomputing.

October 1978  
Review 1: Commodore Pet I. Review 2: VDUs - Computer Workshop CT-64. Strumtech Engineering ACT-1. Music on a KIM. Micro v. Calculator. VAT accounting complete program Part 1.

November 1978  
Review: Tandy TRS-80. Projects for KIM: Pet goes to school; VAT accounting complete program Part 2: Complete game program - Mastermind. Software Dynamics Basic compiler review.

December 1978  
Review: Research Machines 380Z. Choosing your first computer; ITT interview. Complete games programs - Battleships. Racing Cars and Monsters: A microcomputerised reservation system.

January 1979  
Review: Nascom I. Convert an IBM typewriter into a terminal Part 1: In-car computing - Pet in the Panther DeVille. Report from the Los Angeles Computer Faire. Pascal v Basic.



February 1979  
Reviews: Cromemco Z-2D. Low-cost peripherals. Systems for estate agents and doctors. A £1000 payroll system. IBM typewriter conversion Part 2: Complete game program - Warlock Warren.



March 1979  
Review: Single-board computers for less than £50. Low-cost stock-control systems. IBM typewriter conversion Part 3. New monthly column - Tandy Forum. Complete game program - NIM.



April 1979  
Review: North Star Horizon Business accounting systems. Apple II design story Part 1: Computerised school meals: Finance for school computing. Build your own frequency meter. Star Trek game.



May 1979  
Reviews: Exidy Sorcerer. Science of Cambridge Mk 14. Printers for less than £1000. Order processing/invoicing packages. Retire with your computer: Apple II design story Part 2. Slalom game.



June 1979  
Reviews: Compucolor II. Ohio Superboard II. Low-cost word-processing: Computing in a pharmacy. Designing a small business application Part 1. Computer v. Brain. Zombie game.



July 1979  
Reviews: AIM-65. SOL-20. Choosing your first computer. Interfacing Pet with a mainframe. Nascom story. Designing a small business application Part 2. Biorhythms program.



August 1979  
Reviews: Pet II. KIM. Pros and cons of PASCAL. Microcomputer user groups. Designing a small business application Part 3: Interfacing Pet with a mainframe Part 2: Life game program.



September 1979  
Reviews: Powerhouse 2. Acorn. Anadex and Heathkit printers. Artificial intelligence: Build your own joystick. Computer scene in the North-West. Mathematics on a Pet. Self-teaching games program.



October 1979  
Reviews: Disc systems for Pet, Apple II and Tandy. Build an electronic scoreboard: Inside Speak & Spell: Introduction to LISP: Inside Prestel.

Only the above issues are still available. To keep your copies of *Practical Computing* in good condition and convenient for reference you will need a special binder. In blue, with *Practical Computing* in silver-style lettering on the spine, each holds twelve issues comfortably. Fill in the coupon opposite and return it with your remittance to *Practical Computing*, Room 125, Dorset House, Stamford Street, London SE1 9LU.

## TOPMARK Computers

dedicated to  
**APPLE II**

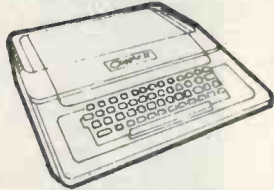

Simply the best!

Full details from Tom Piercy on Huntingdon (0480) 212563 or circle enquiry card.

• Circle No. 208

## WE PROGRAM MICROS

- \*Occasionally for Ohios\*
- \*Periodically for Pets\*
- \*Also for Apples\*

## S Software Services

14 Herbert Street, Dublin 2, Ireland.  
Tel: 765197

• Circle No. 209

### Special Offer!



Limited to first consignment only at special offer price of £187 (normally at least £230) this Stand-alone, high-resolution visual display unit includes all these features:-

- \* 12in CRT implosion protected, monochrome OR GREEN PHOSPHORS
  - \* Better than 700 lines at centre, at least 80 characters across
  - \* High-resolution graphics. 190 dots horizontally
  - \* Constant stability, high brightness, perfect locking
  - \* Excellent, world-wide market penetration, famous make
  - \* Fully guaranteed, proper service backing.
- 10 in. model also available, same specification £142.56 + VAT.  
Money back if not delighted (10 days)

Cash with Order to:-  
InterScan Division  
Hamble Wilkes Ltd,  
23 Acre Lane,  
Carshalton,  
Surrey.

Tel: 01-669 4611.

Dimensions (12in Screen)  
(W.H.D)  
320 x 318 x 255mm.  
(12½ x 12½ x 10 in.)  
Weight 10.5kg (22.5 lbs.)  
9in & 17in also available.

• Circle No. 210

# Possum on the Pet

The versatility of the microcomputer makes it particularly useful to the severely disabled. In the first of two articles we look at a *Possum* system for the Pet.

SOME TIME AGO *Practical Computing* ran a competition in which entrants were invited, with an Apple II as the prize, to devise a useful and interesting application for a microprocessor. The Seagrave family won with an entry for a microprocessor-based typewriter system for aiding the severely physically handicapped.

There is a very wide range of ills to which people can fall victim, both mental and physical. Considerable effort has gone into the search for gadgets and aids to help these individuals. Often the simplest ideas can be of most value; a knife fork or spoon can be re-designed, a chair modified, to the enormous everyday benefit of the handicapped. At the other end of the scale, houses can be re-designed to suit an individual, or cars can be altered, to give the disabled person greatly-increased independence and to reduce the degree to which they must rely on nurses, friends and relatives.

It is in that light that the following text and program is presented. The source of the program is in Basic, and it runs on the Commodore Pet.

While the program is long and fairly complicated, it has been developed and tested over an extended period and has proved to be robust. It should not be difficult to modify it to suit individual circumstances. It is a prototype laboratory set-up, never having been used by anyone who couldn't, if they became bored, walk

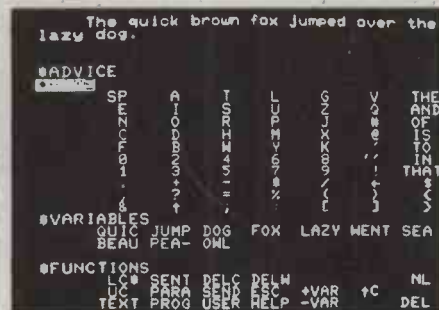

The Possum display. The cursor is at Home, shown by reverse display in the top left-hand corner of the menu, shown by reverse character display.

away or, if it did not do as they wanted, to change or modify it.

It is the dual problem of reliability and usability which must be given special priority if computers are to help the disabled. Those considerations should be met by conservative design principles and thorough testing even though the cost, in both effort and money, will be increased.

The idea is not new. Equipment to do these things has been available for years and has helped countless people. By departing little from this well-tried and tested formula, only by adding new features and making small improvements can we hope that computer-based equip-

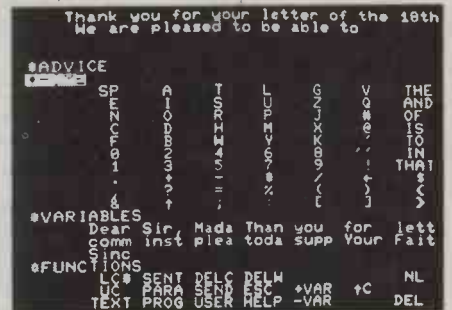

Possum being used to write a business letter. Standard words and phrases have been chosen from the variables list and loaded into the text buffer at the top of the screen.

ment, with its potential for greater flexibility and power, will gain rapid acceptance.

My interest in these machines was inspired by a visit to an exhibition aimed at demonstrating a wide range of aids for the disabled, writes Nick Hampshire. Among other exhibits was a Possum typewriter control system.

In essence, the user is provided with modified electric typewriter, a control board which displays the letters of the alphabet, the digits and other symbols a typewriter can print, arranged as a matrix, with a mouth switch, operated by sucking and blowing down a tube.

### Variation

Carriage return and upper/lower-case shift are also displayed on the board. A character is selected first by blowing into the tube. An illuminated cursor will move across each of the columns in turn. Sucking selects the row containing the wanted option which can then be printed on the typewriter. When the user sucks and blows, each little box in a row or column is illuminated in turn to show which is being selected. The speed at which the cursor or pointer moves may be altered to suit the person using the machine.

The idea of selecting a column and then a row in turn is a variation of the menu selection technique, which may be employed whenever there is a limitation to





## TVJ MICROCOMPUTERS ETC

### ARE EXPANDING...

and require staff for their branches at

BRISTOL, OXFORD & CAMBERLEY

Applicants should preferably have qualifications in computing science and experience in computer sales.

In the first instance, those interested should write to S.G. Johnson giving details of age, education, training, past employment and experience.

**T & V Johnson**  
(Microcomputers  
Etc) Ltd  
165 London Road,  
Camberley, Surrey,  
GU15 3JS

## profcomp

### HELP YOUR MICRO TO HELP YOU

- \* Micro-computers and peripherals
- \* Feasibility studies
- \* Machine evaluation and selection
- \* Systems to your requirements
- \* Software packages
- \* Books

For our PROFessional COMPuter advice, service or products, write or phone:

Profcomp Ltd., 107 George Lane,  
London E18 1AN 01-989 8177

• Circle No. 215

(continued from previous page)

their distance — though not particularly rigorously — from the Home position. The other special characters are dotted around the edge. A few English words which occur frequently, such as “THE”, “AND” and “OR” have been included down the right-hand side and it is very convenient to have them. One early idea was to include frequently-used letter pairs, such as “TH”, but that is less easy to do.

The fourth region is labelled “VARIABLES”. Those boxes will contain words, phrases or complete sentences the user decides he or she will need to use frequently. Photograph 1 shows some of the individual words used in the text at the top, set up as variables.

Each of the 21 boxes contains the first four characters of the contents of the variable. Thus “QUIC” contains “QUICK”, “BEAU” contains “BEAUTIFUL” and “PEA-” contains “PEA-GREEN” one of the examples is “The owl and the pussycat went to sea in a beautiful pea-green boat”.

### Edit boxes

It was a major design decision how the generation of a new variable word be arranged. Initially I assumed that a variable should be made from the most-recently-typed word in the text buffer. The final program makes the whole of the text buffer into the variable, although only the first four characters are displayed on the screen. One must therefore type each of the words or phrases to be stored and put them in their locations before starting in earnest. Figure 2 shows a more realistic situation. Each of the variable boxes contains some small part of a potential business letter. As most business letters seem to be of a kind the scheme is well matched. Such phrases as “Dear Sir or Madam”, “Thank you for your”, “unless your account is”, “Yours faithfully” and so on, may all save a huge amount of effort. A small selection of candidates — most of them single words — is shown. If a set of words proves to be very useful they could be built into the program. The Possum company supplies a word storage add-on module with eight or 64 words which it claims can cover up to 20 percent and 50 percent of word usage.

The final region on the screen is labelled “FUNCTIONS”; by selecting those boxes more interesting things happen. The functions can be divided into a number of types. By far the largest group is formed by the edit boxes. They help the user to type English into the text buffer, which will then be printed on to the external printer.

“UC” and “LC” are obvious. The first sets the shift-lock; all letters added to the buffer will be in upper-case, the second unshifts it and letters are added in lower-

case. The current mode is indicated by a “\*” against the relevant function.

There are some exceptions to the rule concerning the words and variables. The words “THE”, “AND” are stored in upper-case and will be printed in upper-case if “UC” is set and in lower-case if “LC” is set, including the stored capitals — figure 2 — but will be printed as they “LC” is set, including the stored capitals. — figure two — but will be printed as they are stored, lower as lower, capital as capital if “UC” is set. That is probably the best compromise in the circumstances.

“SENT” is another function which,

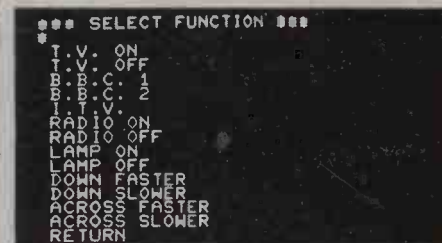

USER function produces a menu of external devices which can be controlled using the cursor.

affects “UC” and “LC”: it stands for ‘end of sentence’. Its effect is to add a full stop and three spaces to the buffer and make the next letter a capital, so that “THE” would be added to the buffer as “The”.

“DEL C”, deletes the most recent character in the buffer and “DEL W”, deletes the most recent word, back to, but not including, the next space. There are true editing commands which give the microprocessor system a great advantage over direct control versions. If you make a mistake — and it isn’t difficult to overshoot the desired box accidentally — it can be corrected before the printer makes it indelible. “DEL” removes the whole text buffer with no other effects. It is put in the bottom right-hand corner to try to prevent accidental erasure.

So far, none of these functions has affected the printer but the next group do. “SEND” prints the contents of the text buffer on the printer, takes a new line and erases the contents of the text buffer. One of the design options was to have “SEND” format the text either partially or fully. Perhaps this might have been done using a full text formatter but more probably by printing the buffer until the line on the printer was long enough — newline IF tab 60 and char = space. This addition would be valuable if longer variable phrases were to be used often.

### Combination

“NL” takes a new line on the external printer, with no other effect. “PARA” is the special case of a new paragraph. Its effect is a combination of the previous three. It prints-out and erases the current buffer, takes three new lines, adds three spaces to the new text buffer to indent the



text, and sets the next letter to be a capital.

“+VAR” and “-VAR” make and remove variables. The effect of “+VAR” is to add a variable. The contents of the text buffer are stored and the first four characters are displayed in the next free variable box, as an *aide-memoire*.

“\*ADVICE” messages are generated if there is no free variable location. When a variable is no longer required, or some free space is needed, any variable can be removed with “-VAR”. The “\*ADVICE” given then is to select the variable to be removed. When that is done, the remaining variables move up to fill the empty space. The program tests and then advises if the variable location selected is already empty or some non-variable box is selected inadvertently.

So far we have discussed typing only in English. It is, however, possible that the user will be interested in other types of text generation for which the rules and assumptions made already do not apply. A case in point might be a keen musician. A totally different notation would be required and the micro would have to be interfaced with a synthesiser to complete the system.

Alternatively, by selecting the function “PROG” the whole screen and system is changed to be a Basic typewriter — Figure 3 — instead of displaying the letters of the alphabet and English words, it shows the digits, special Basic characters, system calls and function names typical of the Basic language.

## Good person

The ‘variables’ and ‘functions’ are unchanged between “TEXT” and “PROG” modes, so a list of up to 21 variables — this time Basic variables like ‘A1’ or ‘Qs’, rather than words or phrases — may be set up and the system works as

```
4 POKE 59459,127:POKE59471,127
5 POKE59468,14
6 PR=5:MC=6
```

```
10 DATA LC "SENT", "DELC", "DELW", "NL"
20 DATA UC "PARA", "SEND", "ESC", "+VAR", "C"
30 DATA TEXT "PROG", "USER", "HELP", "-VAR", "DEL"
100 DATA SP "A,T,L,G,V," THE
110 DATAE, I,S,U,Z,Q, AND
120 DATAN, O,R,P, J, #, OF
130 DATAC, D,H,M,X, @, IS
140 DATAF, B,W,Y,K, ', TO
150 DATAO, 2,4,6,8, ', IN
160 DATA1, 3,5,7,9, !, THAT
170 DATA ., +, -, *, /, %, $
180 DATA ", ? , =, %, (, ), <
190 DATA &, ^, ", ", ", [, ], >
200 DATA "A,T,L,G,V,THE
210 DATAE, I,S,U,Z,Q,AND
220 DATAN, O,R,P, J, #, OF
230 DATAC, D,H,M,X, @, IS
240 DATAF, B,W,Y,K, ', TO
250 DATAO, 2,4,6,8, ', IN
260 DATA1, 3,5,7,9, !, THAT
270 DATA ., +, -, *, /, %, $
280 DATA ", ? , =, %, (, ), <
290 DATA &, ^, ", ", ", [, ], >
400 DATA SP "1,7,=", "C", "GOTO", "ON"
410 DATAO, 2,6, ", ", "INFUT", "VAL"
420 DATA3, 4,5, #, C, "POKE", "CHR#"
430 DATAB, 9, ", ", "C", "PEEK", "STR#"
440 DATA (, #, ^, " ) = ", "LEN", "LEFT#"
(continued on next page)
```

before. Words are created in “TEXT” mode and Basic things in “PROG” mode, so one can easily skip between the two to generate strings like “NOT ZERO” in figure 3.

There is no need to display on the screen exactly what will be added to the buffer; the “PROG” frame shows that to a greater degree than “TEXT”. Some of the boxes contain abbreviations, such as “RTRN” for “RETURN” and “TRON” for “TRACEON”. Moreover, each of the functions also includes its opening left bracket, so “ASC” is actually “ASC(” and “RIGHT” is “RIGHT(”, which improves the shorthand facilities.

You will notice that the commands and functions are not those of Pet Basic, but SWTP 8K Basic. This is for a good reason: it is not advisable to run an untested and undebugged user program on the Pet if it is your only means of communication.

When your program crashes, goes into an infinite loop or whatever, you are very stuck. Instead, the system sends the Basic text generated in the text buffer to a second microprocessor, using the “ESC” or ‘escape’ function.

That is similar to “SEND”, except that it transmits the text to a different file number through the IEEE port and terminates the line with an escape character — at the moment CR/LF, but it could be an escape or an ASCII control character. “{C” is a second special programming function which sends the ASCII character 3 to the second micro, allowing a ‘break-in’ to occur if the program fails. One must contrive to have the second micro output to the printer as it runs.

This month the bulk of the program is presented. In part two the working and structure of the program will be explained and documented.

**ALGOBEL  
COMPUTERS LTD.**  
33, Cornwall Buildings  
Newhall Street  
Birmingham B3 3QR  
Tel. 021-233 2407/1652

## APPLE II Software

### PAYROLL

- Straightforward, comprehensive, professional, *and it works*
  - To I.R. specifications
  - Calc Gross monthly/weekly/fortnightly/4 weekly Overtime, Hol. Pay, Bonus, Additions
  - Calc tax and N.I. contributions
  - C/o pensions
  - neat payslips
  - Wages Book
  - Coin Analysis
  - Year end tax for each employee and employer
  - Additional utilities: calculate tax & N.I. for 1-off pay or special payroll, day of the week and difference between two dates.
  - Capacity: 45 employees in 1 disc drive only, or 45 employees in two discs.
  - Price £235 plus VAT.
- W/PROC ON DISC format & edit text and paragraphs.  
Address file; address each letter and print labels. £75 plus VAT.
- ESTATE AGENTS select properties & issue mail list.  
MUCH MORE TO COME.  
EQUIPMENT: Apple II £750; add-on to 48K and I/F serial £230; disc drive w/contr. £355; Teletype 43 £850 (add VAT.). LEASE and HP immediately available. Large discount on software.

• Circle No. 216

## FIFTY Hz Superboard £190

British Standard plus  
OFFICIAL dealer support  
plus  
ASS/ED, EX/MON AND  
OTHER SOFTWARE AND  
EXPANSION AVAILABLE  
C.T.S., 1 Higher Calderbrook  
Littleborough,  
Lancs OL15 9NL  
Tel. Littleborough (0706) 79332  
ANYTIME

• Circle No. 217







# BUYERS' GUIDE

The Buyers' Guide is a summary of low-cost computers available in this country. It appears each month; we add new computers and amend existing information, as required, to keep it up-to-date. Systems are listed by manufacturer.

## ACORN COMPUTERS

**Acorn.** Single Eurocard-sized microcomputer with 6520 processor, 1KB RAM, 16-way I/O. Max size; a second Eurocard adds hex keypad and CUTS cassette interface. Monitor and machine-code programming now. Basic and disc operating system in the future. "Highly cost-effective basis for a computer or an industrial development system". Available from Acorn (0223) 312772 or Microdigital (051) 236 0707.

£74.75 kit, £86.25 assembled

## APPLE COMPUTERS

**Apple II.** Min size: 16K memory; 8K ROM; keyboard; monitors; mini assembler; colour graphics; Pal card; RF modulator; games; paddles and speakers; 4 demo cassettes. Max size; Expandable to 48K memory; floppy discs and printers are now available. Two versions of Basic, PASCAL; Assembler; games; business packages. An American system regarded as suitable for any kind of applications. Maintenance contracts offered. Microsense Computers is the sole U.K. distributor and has a national dealer network. Tel: (0442) 41191/48151 (24-hour answering service).

Around £1,000

## ATTACHE

**Attache.** Min size: system with 10 slots, S100 bus, 8080 processor and 16KB housed in desk-top case with built-in keyboard. Max size: 64KB, parallel printer interface, two single- or double-density 8in. floppies, video screen. Disc Basic; business applications produced by Moncoland, the sole U.K. agent. Distributors include Keen, GBH, Alba, and Lion.

From £1,737. Full business system about £5,000

## BRUTECH ELECTRONICS.

**BEM-CPUI.** Single-board processor with 6502 and no RAM. Applications software. Available from Data Precision Equipment (04862 67420). (Reviewed March, 1979.)

£133 exc VAT

## BYTRONIX MICROCOMPUTERS

**Megamicro.** 8080A/Z-80 processor. 64K. Double-sided discs, two-page addressable VDU, 140 cps printer. Software includes Basic, Fortran, Cobol and Pascal, all running under CP/M. Applications include automatic letter writer, sales ledger and stock control, payroll and bought ledger. Self-diagnosis utilities. Aimed at business and university user. Available from Bytronix (0252) 726814.

From £6,080.



## APPLE II IN SCOTLAND

Why not call and see the fantastic Apple II, the finest micro currently available?

Complete hardware, software and peripheral service available, inc. discs, printers and colour monitors.

Call us for hands-on demonstration without obligation



### SUPERCOLOUR

At last top quality colour for your Apple II. Converts Apple signals to separate red, green, blue and sine signals. No modulator required. 14in colour monitors available. Send for details now.

### PRINTERS

High-speed 112 char/sec, top quality. Uses plain paper, Tractor-fed £575 + VAT.

### PASCAL

Now available. The most powerful micro-language yet. Features too numerous to fit this ad. Full details by return of post.

### MONITORS

ATTACHÉ Top quality b/w monitors now available. Plug straight into Apple. No modulator required.

**Brand New Product.** Chiptester. Converts Nascom to a super powerful I.C. tester. Plugs into existing ports. Send now for full details.

**Five exciting new games for Nascom I** (no expansion required. Compatible T2, T4, B-Bug monitor). Cassette and printed booklet giving full details. Price £10 + VAT.

Software and Books ideal for schools and colleges now available.

### STRATHAND

44 ST ANDREWS SQUARE  
GLASGOW, G1 5PL

Tel: 041-552 6731 Telex: 777268

CALLERS WELCOME

Telephone orders taken. Access, Barclaycard and cheque.



• Circle No. 227

# SHOP WINDOW

## FLOPPY DISKETTES

5 1/4" and 8" single and double sided/density. Available from stock at competitive prices.



Also all other computer media and supplies, including

Cassettes  
Ribbons  
Print Wheels

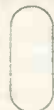

Storage Systems  
Computer Files  
Stationery

Michael Collins Computer Supplies Limited,  
52, Canbury Passage, Kingston, Surrey.  
Telephone: 01-549 9441

• Circle No. 228

## Some people would give anything to have your micro experience

If you have solid experience on Intel 8080 or similar and are interested in contract work Richard Kaluzynski will put you in touch with them.

Knight Computer Services Limited,  
14 Old Park Lane, London W1Y 4NL.  
Tel: 01-491 4706.



Staff Services Division of BOC Datasolve Group and a member of Computing Services Association

• Circle No. 229

**THE BEST FOR LESS!**  
Computers, Firmware,  
Software  
Most Makes Bought,  
Sold, Exchanged,  
Constructed.  
PET ITT ELF & NOW  
NEW SHARPI  
PETSOFT & GEMSOFT

Examples of low, low prices:—  
Teletext Decoder £215. Grandstand  
Games Computer £115.  
Sharp 10K £499; 18K £599; 22K £619;  
34K £699. All plus VAT/Carriage.  
OPTELCO

PHONE: RAYLEIGH (0268) 774089  
UP TO 8 pm

• Circle No. 230

## COMART

**Microbox.** Chassis with three to six PCB sockets for S100 boards, plus fan. Several S100 boards available. Aimed mainly at OEM industrial users and perhaps the serious hobbyist. It will take Cromemco, North Star and other processors. Available from Comart (0480 215005).

£255

## COMMODORE SYSTEMS DIVISION

**Pet.** Single unit containing screen, tape cassette and keyboard. Floppy disc, printer and full-size keyboard are options, as are external cassettes. Basic; games; business packages. The British subsidiary of Commodore Systems of the U.S. sells Pet for home, educational and small business applications. About 80 distributors.

£460-£795 exc VAT

**Kim-1.** processor (6502 chip); small calculator-type keyboard; LED six-digit display; built-in interfaces for audio-cassette and Tele-type; IK RAM; 2K ROM (can add up to 64K). No software available, but it has three good manuals. An American import which gives Pet-type capabilities with a maximum configuration. For the hobbyist but used mainly as an evaluation board for the 6502 chip. Twelve to 15 dealers. (Reviewed October, 1978.).

£99.95

## COMPELEC ELECTRONICS

**Series I.** Z-80 processor 512MB floppy, 32KB, Centronics printer, VDU. Up to 4MB disc and 64KB. CP/M, Basic, Cobol, PASCAL, Fortran IV, Assembler, Business and word processing packages available. From Compelec (01-580 6296), which is also sole supplier of Altair systems.

Less than £5,000 for basic system

## COMPUCOLOR

**Compucolor II.** Packaged system including 13in. eight-colour display with alphanumerics and graphics, 72-key detachable keyboard, 8KB, and built-in mini-floppy. Max size: 32KB. Extended disc. Basic in ROM, graphics programs and games. The system now ranks fourth behind Pet, TRS-80 and Apple in personal computer sales. Abacus (01-580 8841) is sole U.K. agent and is arranging distributors, including the Byte Shop and Transam. (Reviewed June, 1979.)

From £1,390

## COMPUCORP

**610:** desk-top unit using Z-80 and incorporating screen, 150KB floppy, 48KB. Up to 60 KB memory, four floppies, printers. Basic, Assembler, DOS, text editor, file manager; business packages. Nine dealers.

From £3,890

## COMPUTER CENTRE

**Mini kit:** Z-80 CPU, CTC, USART, serial and parallel I/O, 16 bytes memory, Western Digital disc controller, SA400 5in. drive plus CP/M, cables and connectors.

Mini kit: £786

**Maxi kit:** As above but with DRI 7100 8in. drive instead of 5in. drive. All (33) volumes of CP/M user group library available for cost of media. Library includes utilities, games. Basic compilers/interpreters and Algol compiler. Microsoft Basic, Cobol, Fortran also available. Computer Centre (02514 29607).

Maxi kit: £886

## COMPUTER WORKSHOP

**System 1.** Typical size: 40K memory; dual 8in. floppy disc, total storage capacity 1.2MB; Ricoh daisywheel printer.

System 1, £5,000 plus

**System 2.** Typical size: 24K memory; dual minifloppy discs of 80K bytes each; Centronics 779 dot matrix printer; VDU.

System 2, around £3,000

**System 3.** 12K memory, cassette interface; 40-column dot matrix printer. Editors, Assemblers, Basic, games, information retrieval package. The systems were designed and built in Peterborough and are suitable for educational and small business users and perhaps the more serious hobbyist. Twenty-five dealers.

System 3, from £1,300





## CROMEMCO

**Single-card computer.** 4MHz Z-80 CPU, S100 bus, 1KB RAM, sockets for 8K ROM. 20mA/RS232 serial interface and parallel bidirectional interface. Basic in ROM and Z-80 monitor. For OEM and industrial users; used with backplane for "full computer capability". Datron Interform and Comart are agents, the latter with 12 distributors. (Reviewed February, 1979.) £247-£281

**Z-2.** Min size: chassis, 31A power supply, motherboard, Z-80 processor, 16KB memory. Max size: 512KB, 21 sockets, three mini-floppies or four 8in. floppies. Basic, Fortran, Cobol, assemblers. For serious hobbyists, OEMs, educational applications, and industrial/scientific users. £372 (in kit form) to more than £4,000

**System Two.** Min size: factory-assembled system with 32KB, dual 90K minifloppies, dual printer interface, serial interface. Max size: two additional floppies, 512KB, up to seven terminals, CP/M-compatible operating system (CDOS), Fortran, Cobol, Basic, assemblers, word processing, database manager. Multi-user system for software development, or scientific/industrial/business users. £1,995 upwards

**System Two/64.** New configuration featuring mini-diskette drives and 64K bytes memory. Software and applications as System Two. £1,995

**System Three.** Min size: 32KB, dual 256KB floppies, dual printer interface, 20mA/RS232 serial interface, Z-80 processor. Max size: two additional discs, 12KB, seven terminals, multi-channel A/D and D/A interface, PROM programmer. Software as for System Two. Described as appropriate for small to medium business, scientific and industrial users — "rivals minicomputers at more than twice the price". £2,995 to more than £8,000

**System Three/64.** New configuration featuring dual 8in. diskette drives; Z-80A processor; 64K of 4MHz memory; console and printer interfaces. Macro Assembler, Fortran IV, Extended Basic, Cobol, Multi-user Basic. Prices quoted by Micro Centre (031-225 2022). £3,293

## DYLE HOUSE

**Business Computing System 2000.** Z-80A. Dual 8in. discs, 140 cps 132 char printer. Dyle House Business Basic, and disc operating system. Accountancy, payroll and parts control suites. Applications: Sales acknowledgments, sales invoices, delivery notes, purchase orders, customer statements, remittance advice. Dyle House Ltd (01-529 2436). No price announced

## EQUINOX

**Equinox 300.** Min size; 48K memory; dual floppy discs giving 600K bytes of storage; 16-bit Western Digital m.p.u. Max size; up to 256K memory; up to four 10MB hard discs. Basic, Lisp, PASCAL, Macro Assembler, Text Processor. All software bundled. The system is a multi-user, multi-tasking, time-sharing system for two to 12 users. Application software available for general commercial users. Sole distributors Equinox Computers Ltd (01-739 2387). £5,000-£40,000 plus

## EXIDY

**Sorcerer:** based on Z-80, 16K and 32K; cartridge and cassette interfaces; 79-key keyboard; 256-character set (128 graphics symbols), 12in. video monitor; expandable with Micropolis floppy discs. Basic, Assembler and Editor; games, word processor. Other pre-packaged programs plus EPROM Pack for your own programs on cartridges. Factor One is sole distributor for U.K. (Reviewed March, 1979.) From £760 without VDU to £1,200 with floppy discs

## HEATH SCHLUMBERGER

**H8.** 8080 CPU. 4664K PAM. Serial/cassette I/O; front parallel monitor; keypad; optional parallel I/O; serial multiport; breadboard I/O and disc system. Basic, Ext. Basic, Mierosoft Basic, HDOS, CPM. From £262 (in kit form)

**WH89.** All-in-one computer. Z-80 processor plus Z-80-controlled VDU. 16K expandable to 48K, user-accessible. Two RS232 I/O ports. Operating system includes Benton Harbour Basic, two-pass absolute assembler, text editor, utility programs, Mierosoft Basic and Fortran word processor package. Heath Schlumberger (0452 29451). About £1,600

A complete Service for the  
 small Business User.  
 SYSTEMS FROM £4,500  
 Ring: 01-653 0835 for brochures.

**IRSTAR**  
**BUSINESS SYSTEMS LTD.**

THE CROYDON-BASED MICRO HOUSE

• Circle No. 231



## Dyna-Byte

fully assembled  
burned in S100

16K Dynamic	RAM	£198
16K Static	RAM 250ns	£271
16K Static	RAM 450ns	£266
32K Static	RAM 250ns	£506
32K Static	RAM 450ns	£470

80 : 24 video terminal, just add key-board and monitor £177.  
Cable set for video terminal £7.20

Postfree. Add VAT to all prices.

S.W.C. Electronic distributors, P.O.  
Box 30, London E.4.

• Circle No. 232

## INTRODUCTORY COURSES MICROPROCESSORS

- Three day course near London (non-residential)
- Small groups only
- HANDS-ON experience (Rockwell 6500\* based AIM65)
- Display and Printer output (take your program home)
- Comprehensive course material

Information and booking:

### MICROSYSTEMS CONSULTANTS LIMITED

P.O. Box 65, Camberley,  
Surrey GU15 1QN  
Tel: Camberley (0276) 27417

\*used in Pet, Kim, Apple, Sym 1  
Ohio-Superboard

• Circle No. 233

## PET USERS!

We have numerous games, educational, scientific and general business programs available, as well as various interfaces, s.a.e. for details.

We require original programs and interfaces, if you have one (or more) send for evaluation. Very good royalties paid: —

**Qwerty Computer Services,**  
20 Worcester Road,  
Newton Hall,  
Durham, DH1 5PZ.  
(Tel: Jim, Durham 67045)

• Circle No. 234

## HEWART MICROELECTRONICS

**Mini 6800 Mk II.** IK monitor; IK user RAM, IK VDU RAM; CUTS. Upper- and lower-case VDU with graphics option. 128-byte scratchpad; decoder/buffer; power supply; Basic in ROM; monitor command summary. SWTPC programs; Newbear 6800; Scelbi 6800 Cookbook. Markets are small business, education and home user. Cash with order to Hewart. (0625) 22030.

From £127.50  
plus VAT

**6800S.** 16K dynamic RAM; IK Mikbug-compatible monitor; room for 8K Basic in ROM; upper- and lower-case graphics; single floppy disc drive; printer and high-speed tape interfaces. "Mountains of software available." Test tape with CUTS test tones, test message and games with kit.

From £275 plus  
VAT

## DIGITAL MICRO SYSTEMS

**DSC-2.** Min size; 32KB, but 64K standard; Z-80; over 1MB floppy disc on two single-sided 8in. drives; four programmable RS232 and one parallel interface. CPM and Basic included in price. Extended Basic, Fortran, Cobol, text processing, Macro Assembler, Link Loader, business packages and CAP-CPP business software. Add-on rigid disc system (14 and 28MB) available soon. Modata (0892 39591) is sole U.K. distributor; dealers being appointed.

From £4,465

## IMSAI

**VDP 40:** 32K or 64K RAM memory; 9in. display screen, standard keyboard. Two 5¼in. floppy disc drives; serial I/O. Full software support, and packages available for the VDP 42, which has larger disc capacity. Packages for VDP 80 could be converted for smaller systems. This would be from about £700 per package. Two main dealers in the country.

£4,507 for 32K  
model. £4,950 for  
VDP 42

## ITT

**2020.** Identical to Apple II. Min. size: 4K memory; 8K ROM; keyboard, monitor, colour graphics, mini assembler; Powell card; RF Modulator, games, paddles and speaker; Max size: 48K with floppy discs and printers. Basic, Assembler, games, business packages. Generally suited to any type of application. Fifteen wholesalers, including Fairhurst Instruments.

From £827 to  
£3003 for 48K,  
two floppies and  
printer

## LUXOR

**ABC 80.** Min size: 35K with keyboard, CPU 12in. screen and cassette. Max size: 40K RAM with discs. Z-80 processor, loudspeaker with 128 effects, real-time clock. Options: printers, plotter, discs, module cards, digitiser, modem. 60 compatible I/O memory boards. Software: Basic with resident editor; assembler; games; business and educational packages. Personal computer aimed at home market, small business and education. CCS Microsales is U.K. agent and is looking for distributors.

£795 plus VAT

## MICRONICS

**Micros.** Typical size: IK monitor; 47-key solid state keyboard; interfaces for video, cassette, printer and UHF TV; serial I/O, dual parallel I/O parts; 2K RAM; power supply. 2K Basic; British-designed and manufactured system. Claimed to be the cheapest data terminal — a system with an acoustic coupler and VDU for £1,020. Prospective applications for small businesses, process controllers and hobbyists. Manufacturer is sole distributor (01-892 7044).

From £400,  
assembled

## MICRO V

**Microstar.** Single box with twin 8in. floppy discs, 64K RAM, three RS232 serial inputs, STARDOS operating system enables system to have three VDUs, plus a fourth job running simultaneously. Word processing software available. Packages being developed include invoicing system, payroll, accountancy type system. Price includes a reporter generator language. Imported by a Data Efficiency subsidiary, Microsense Computers, Microsolve is London agent; other distributors being arranged.

£4,950 machine  
and software



## MIDWEST SCIENTIFIC INSTRUMENTS

**MSI 6800.** Min size: 16K memory Act I terminal; cassette interface. Max size: three disc systems — minifloppy system with triple drives of 80 bytes each and 32K memory, large floppy system with up to four 312K-byte discs and 56K of memory mounted in a pedestal desk, or hard disc system with 10MB and 56K. Basic interpreter and compiler; editor; assembler; text processor on small disc system. American-designed system being manufactured increasingly in the U.K. Sole U.K. agent is Strumech (SEED) (05433 4321) but a distributor network is being established.

*Basic system:*  
£1,100 (£815 as kit); Minidisc, £2,500; floppy disc £3,200; hard disc, £8,000-£12,000

## NASCOM MICROCOMPUTERS

**Nascom I.** Min size: CPU; 2K memory; parallel I/O; serial data interface; 1K monitor in EPROM. Max size: CPU, 64K memory; up to 16 parallel I/O ports. Mostly games, but also a dedicated text editor system written by ICL Dataskil. Nascom is working on large versions of Basic, and 8K Microsoft Basic should be available soon. Eleven distributors in U.K. Nascom is negotiating to increase the number. (Reviewed January, 1979.)

£165 exc VAT

## NATIONAL MULTIPLEX

**Pegasus.** Min size: 48K, Z-80; double-density floppies (320KB); S100 bus; 12in. CRT; 58-key keyboard; two serial and one parallel interfaces; bi-directional printer. Options: 8in. drives; 1-2MB additional drives; digital recorder 9,600 baud. Assembler, Cobol, Fortran, Extended Basic. General business package available as well as text editing and mailing list. All run under CP/M. Suitable for education, business and home users. London Computer Store (01-388 5721) sole supplier.

£2,700 exc VAT

## NETRONICS

**Elf II:** single-board computer in kit form or assembled. RCA Cosmac 1802 processor, hex keyboard, 256 bytes RAM; options include up to 64KB, ASCII keyboard, cassette and RS232 I/O, and video output. Machine code or Tiny Basic. Promoted as a teaching system in minimal form, but expandable for more general use. Sole U.K. distributor HL Audio (01-739 1582).

*Basic kit* £79.95.  
*Assembled* £99.95. *I/O board* £35

**Explorer 85:** Min size: 4K. Max. size: 64K. 8085A processor, VDU board, ASCII Keyboard, S100 expansion. Cassette, RS232, TTY interface on board. I/O ports, programmable timer. Disc software, Microsoft Basic on cassette, 8080 and Z-80 software can be used. Aimed at hobbyist, OEM and small business. Available from Newtronics (computer division of HL Audio).

*From* £297 plus VAT

## NEWBEAR

**7768.** CPU board, 4K memory, cassette and VDU interfaces. Range of Basics and games. British-manufactured system for hobbyists. Expandable to 64K memory available only in kit form. From Newbear; also from Bearbag dealers, Microdigital, Microbits.

*From* £45

## NORTH STAR

**Horizon.** Min size: 16K memory; Z-80A processor, single minifloppy disc drive (180KB). Max size: 56K memory, four minifloppy disc drives (180KB), any acceptable S100 peripheral boards. Basic (includes random and sequential access), disc operating system and monitor. Options: Basic Compiler, Fortran, Cobol, Pilot, PASCAL and ISAM. The system is suitable for commercial, education and scientific applications. Application software for general commercial users. Twenty distributors. (Reviewed April, 1979.)

£995 to £2,500

## OHIO SCIENTIFIC

**Ohio Superboard II.** Min size: 6502 processor, 8K Basic in ROM; 2K monitor in ROM; 4K RAM; Cassette I/F, full keyboard; 32 x 32 video I/F, 8K Basic in ROM; Assembler/Editor; American single-board system with in-board keyboard. Aimed at hobbyist/small business. Ohio makes games, personal maths tutors, and business programs. This and other Ohio products have six U.K. distributors. (Reviewed June, 1979.)

*From* £298

## INTELLIGENT ARTEFACTS

S100 16K static RAM boards in stock  
— INCREDIBLE VALUE £200  
Z80 CPU cards 4MHZ £100

We import direct from U.S.A., undercutting all competition on PETs, Ohio Scientific, S100 etc.  
Phone for prices: Arrington (022020) 689

Intelligent Artefacts Ltd,  
Cambridge Road,  
Orwell, Nr Royston, Herts

• Circle No. 235

## EPROM ERASER

ERASE 32 DEVICES IN 15 MINS  
RUNS COOL WITH LOW OZONE  
COMPACT, PROFESSIONAL QUALITY UNIT  
200-250V OPERATION  
£39.95 ALL INCLUSIVE  
C.W.O. OR COMPANY ORDER  
FULL DESCRIPTION ON REQUEST

**TEX MICROSYSTEMS LTD**

126 NEW HOUSE PARK, ST. ALBANS.  
64077 AFTER 7 P.M.

• Circle No. 236

## HUMBERSIDE MICROPROCESSOR SERVICES THE COMPLETE INDEPENDENT SERVICE

*Application areas:-*  
Business, process control, education, Personal Computing  
We can provide for you:-  
Consultancy, training, supply, maintenance and software to suit your individual requirements

*Including*  
Commodore PET M6800  
Compec 202 and full ancillary equipment.  
Microprocessor Services,  
139 Beverley Road,  
Hull  
Humberside.

For further details ring (0482) 23146

• Circle No. 237

## Distributors in N. IRELAND for NASCOM

Nascom-1 range in stock. On demonstration Mon-Sat. We are taking orders for Nascom-2 for delivery when available.  
Any micro supplied

**P.&O. COMPUTERS (N.I.)**  
81 Dublin Rd, Belfast  
Tel. (0232) 22010  
After hours 621708  
Doneghmore 312

• Circle No. 238



**ANNOUNCEMENT**

**MICROPROCESSOR STOCKISTS WANTED NO INVESTMENT REQUIRED**

SMALL BUSINESS COMPUTERS, who specialise on packages orientated to the small business end-user, are appointing a number of U.K. microprocessor stockists and dealers; also certain software houses and other specialists, who are in a position to demonstrate, supply and install HARDWARE, from their own stock wherever possible and on which full mark-up will be earned by them. Those appointed will be required to deal directly with the numerous sales leads which SMALL BUSINESS COMPUTERS obtain through national Press advertising.

Dealerships appointed will be required to arrange for demonstrations, and to maintain customer liaison subsequent to system installation.

SMALL BUSINESS COMPUTERS specialise on system design, on packages primarily orientated toward small business and professional end-users, and on management services (financial, maintenance, etc.)

If you are interested, would you kindly write with full details of hardware agencies, stocks held, and the geographical area you are able to cover, to:

**SMALL BUSINESS COMPUTERS, FREEPOST, WEMBLEY, MIDDLESEX.**

• Circle No. 239

**IF YOU NEED . . .**

**HIGH SPEED CASSETTE PROGRAMME DUPLICATION AND THE SUPPLY OF TOP QUALITY CASSETTES . . .**

Why not ring us on 01-399 2476/7 and let us quote you for your next requirements.

**MEDIATAPE LIMITED, 29a Tolworth Park Road, Surbiton, Surrey.**

01-399 2476/7

• Circle No. 240

**COMPUTECH FOR APPLE SYSTEM. APPLICATIONS SOFTWARE**

Professional business software packages now available are turnkey systems with comprehensive manuals, built-in validity checks, interactive enquiry facilities, user options, satisfying accountancy, Inland Revenue and Customs and Excise requirements on diskette with DOS 3.2 and space utility.

Not adaptations, written specifically as packages for the Apple System applications software from £295 ea.

**COMPUTECH SYSTEMS**  
168 Finchley Road, London, NW3

6HP. Tel: 01-794 0202.

**Dealer enquiries welcome.**

• Circle No. 241

**PERTEC**

**System 1300.** Min size: 32K memory; dual minifloppy discs 71 bytes each, formatted; serial interfaces. Max size: 64K memory; four serial parts. Basic (single and multi-user), Fortran, Cobol. The hardware for Compelec Altair systems is from Pertec but the software is Anglo-Dutch. Sole distributor Compelec (01-580 6296).

£3,000-£5,000

**POWERHOUSE MICROPROCESSORS**

**Powerhouse 2:** desk-top unit using Z-80 with 5in. built-in VDU and built-in mini cassette. 16K or 32K RAM, full keyboard, real-time clock, two spare slots. RS232 interface. Software: Disc and cassette operating system, programmable keyboard, 16K PROM, extended Basic. Options: 14K Basic, X-Y graphics, 2K monitor, larger screen, discs. Compatible with all computers. Aimed at OEMs and expert users such as scientists or researchers. Applications include real-time process control, engineering calculations. Availability: Powerhouse only (0442) 42002. Reviewed, September 1979.

£1,480-£1,760

**PROCESSOR TECHNOLOGY**

**Sol.** 808-based S100 microcomputer packaged with cassette and video interfaces (including graphics), keyboard with numeric pad, and 16KB RAM. Basic, assembler, word processors. Floppy disc systems available. Several distributors including Comart (0480 215005), which can offer nationwide maintenance contracts (Reviewed July, 1979.)

From £1,750 (excluding monitor and cassette). Complete floppy disc systems with word processing about £5,000

**RAIR**

**Black Box.** Min size: 32K memory dual minifloppy discs, 80K bytes each; two programmable serial I/O interfaces. Max size: 64K memory; eight serial interfaces; 1MB disc storage (or 10MB hard disc); range of peripherals. Basic, Fortran IV, Cobol. Hardware distributors are being signed and agreements made with software houses to add software. A warranty and U.K.-wide on-site maintenance is given. From manufacturer (01-836 4663) and systems houses.

From £2,300

**RESEARCH MACHINES LTD**

**380-Z.** Min size: 4K memory; 380-Z processor, keyboard. Max size: 56K memory. Options: cassette, single or dual minifloppy discs, dual 8in. double-sided, discs (1MB); serial interfaces; parallel interfaces; analogue interface; printer available. Basic Interpreter, Z-80 Assembler; interactive text editor; terminal mode software; data logging routines; CP/M, DOS, text processor, CBasic, Fortran, Algol, Pilot, Cobol, CP/M users' club library. Sold principally to higher and secondary education, and for scientific research, data processing and data logging. Available from Sintel and the manufacturer. (Reviewed December, 1978.)

From £830-£3,500

**280-Z.** Board version of 380-Z system, 4K or 32K (identical in performance to the 380-Z). Interfaces, software as for 380-Z.

4KB version at £398; 32KB for £722

**RCA**

**Cosmac.** 1802 micro with hex keypad and output to TV screen. Assembler and machine code programming; options include Tiny Basic. Available by mail order from HL Audio (01-739 1582).

Kit £79.95. Assembled £99.95 exc VAT

**ROCKWELL**

**Aim-65.** Kim-compatible with full keyboard and on-board printer. 1K or 4K RAM. The 4K version is described as a development system rather than a personal computer. Assembler, editor, Basic. Available from Pelco, Microdigital and Portable Microsystems (Reviewed July, 1979.)

1K - £249.50  
4K - £315

**SCIENCE OF CAMBRIDGE**

**Mk 14.** SC/MP processor, 256 bytes user memory; 512-byte PROM with monitor program; hex keyboard and eight-digit, seven-segment display; interface circuitry; 5V regulator on board. To this can be added: ¼K RAM (£3.60); 16-I/O chip (£7.80); cassette interface kit

£39.95 basic



(£5.95); cassette interface and replacement monitor (£78.95); PROM Programmer (£9.95). No software provided but a 100-page manual includes a number which will fit into 256 bytes covering monitors, maths, electronics systems, music and miscellaneous. Based on American National Semiconductor chips. Science will soon have a VDU Interface and large manual on user programming. Mail order from manufacturer (0223 312919) and by selected dealers. (Reviewed May, 1979.)

## SDS

**SDS 100.** Single unit containing 32K memory (expandable to 46K); up to 8K PROM; twin double-sided floppy disc drives of 500 bytes each, serial and parallel RS232 interfacing; keyboard; 12in. video display; power supplies; SD monitor program; line printer available. CP/M, 8080 assembler, E Basic, Editor supplied with system; M Basic, Fortran, Cobol available for business use, industrial process monitoring and control (with additional hardware). All CP/M games and business packages. Sole supplier Airamco (0294 65530). *From £3,750*

## SEMEL

**Semel I.** Min size: 4K with CPU, keyboard and monitor. Max size: 64K with single floppy disc unit, printer, VDU and keyboard. Can be coupled to any external device and controls up to 8 x 250K floppy disc units. Four configurations available. Options: Light pen attachment; 12V DC power supply; remote terminals. Software: Editor, Assembler, debug, full file-handling capabilities in Basic, Fortran and Cobol available on 64K machine; user-defined programs written and compiled by agreement; word processing. General-purpose unit for use as a terminal controller. Suitable for small business and OEMs. Available from Semel exclusively (0822) 5439. *£1,950 with Basic*

## SORD

**M100.** Min size: 16K RAM; 4K ROM Monitor; full keyboard plus function keypad; two-channel joystick dual cassette I/F; 11K E Basic on cassette; video; graphics; printer; S100 bus; converters; speaker; 24-hour clock. Max size: 48K RAM, 8K ROM; black and white or colour graphics; mini-floppy discs. Suitable for OEMs, small business, education, laboratory and scientific and home computing. Main distributor is Dectrade, but for London and South contact Midas Computer Services (0903) 814523. *From £726*

## SYNERTEK

**Sym 1.** 6502 chip and keypad with memory available in 4K blocks up to 64K. Port expansion kit, TV interface card, RAM expansion kit, cassette and Teletype interfaces. Any Kim software, Basic interpreter, Assembler/Editor, American, meant to be the foundation system for every small business and hobbyist users. Available from Newbear (0635 49223). *From £160 plus VAT.*

## TANDY CORP.

**TRS-80.** Min size: Level I 4K memory; video monitor; cassette; power supply. Max size: Level II 48K up to 350K on-line via floppy discs; line printer; tractor feed printer and quick printer; floppy disc system. Modern, telephone interface soon available. Basic; some business packages. Level I aimed at the hobbyist and education market and Level II at small business applications. Hundreds of dealers. (Reviewed November, 1978.) *Level I — £499  
Level II — from £578-£4,700*

## TRANSAM COMPONENTS

**LA.1.** 1K monitor, 2K Basic in EPROM; full graphics capability; 128 character set; power supply; cabinet; 56-key keyboard. Expandable to 65K. Available from manufacturer (01-402 8137). *£286 kit with SKB*

## VECTOR GRAPHIC

**48KB RAM, Z-80 micro;** 63K bytes, mini-discs are standard. Options: graphics. Monitor, MDOS, Basic; business packages from dealers. Several distributors. *£2,300*

**6800 — 5 BUS.**  
**32K Dynamic Ram Kit**  
available in 16K form at £130  
and only £200 for 32K

**6800S** The world's most powerful single-board 6800-9 computer kit. 16K version with keyboard £299.

**Mini 6800 multi-board system** from £127.50. All prices without VAT and post SAE for leaflets to: **Hewart Microelectronics, 95 Blake-low Road, Macclesfield, Cheshire SK11 7ED.**

• Circle No. 242

## MICRO ADS

are accepted from private readers only, pre-paid and in writing, 20p per word, minimum charge £2.

For Sale: Exidy Sorcerer Computer. I can supply this little-used machine in its 8K, 16K or 32K versions. Only one available so phone now for details. Deal 2132.

Teletype in sound-proofed compact stand, RS232, punch, reader £450. Blackpool 84687.

380Z SOFTWARE. Physics and Maths Teaching Simulations. J. M. Turner, King Edward VII School, Lytham, Lancashire.

Accountant wants partner to develop jointly small business system privately. Must be knowledgeable in micros and Basic. J. Cocks 06285-23121 (Nr High Wycombe).

CCTV SYSTEM. Camera (zoom) plus 19in. monitor. All functions power driven. £150 (07873) 76785.

8080 CPU System with PROM, RAM, I/O £99; Matching Hex Data/Address Display Unit £49; Matching Power Pack +5V, ±12V, +24V £49; EPROM Eraser, little used £39; TMS 4051NL 4Kbit Dynamic RAM Chips £1.99; B3222 suitable refresh control chip £1.99; St. Albans 64077 after 7pm.

### APPLE DISK USERS

Are you looking for software that will handle the tedious chores of file creation, editing and retrieval, allowing you to get on with the real application work? Total package comprises 90K of programs. SAE for details from 109 South Road, Erdington, Birmingham.

Buy my TRS-80 level 2 16K for £500. Hardly used and in perfect shape. Call 061-480 6313 (day) or 061-456 5966 (evg).

For sale — six weeks old APPLE 16K (ITT 2020) in mint condition. Includes carrying case, cassettes, manuals, books. Sale price £1,060 ono. Contact Mr. Shaw, Derby (0332) 831272.

SORCERER (16K). Excellent condition, all accessories, £615.

TV monitor + range of peripheral equipment, £130. Together £715. Southport 65787/64809.

Stacks of memory! 4K-Bit static M.O.S. R.A.M. N.E.C. UPD 410D-2 (100ns) £9.70 ea. + 30p. p&p 8-data P. Town, 30 Wolsey Drive, Walton-on-Thames, Surrey KT12 3AZ. Tel: 21078.

# DP-1000

Series Printers

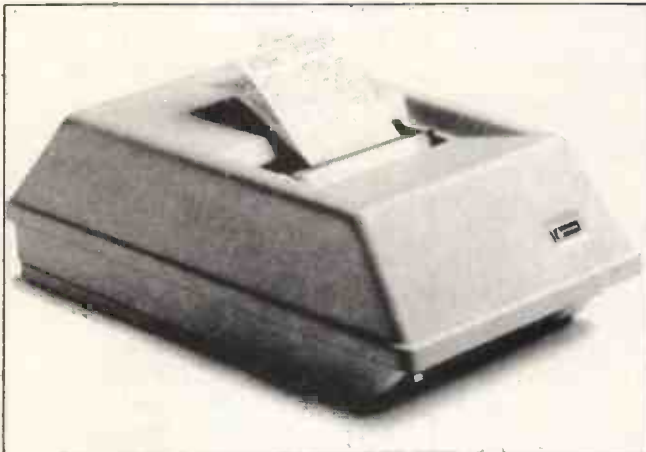

Prints 40 cps in 40 columns.  
Plain paper, multiple copy.  
Data storage – 168 characters.  
Current Loop, RS.232  
Parallel Bit inputs.  
Double width printing selection.

OEM quantity price £295



**Anadex Ltd.**

Dorna House, Guildford Road,  
West End, Woking, Surrey  
GU24 9PW  
Phone: Chobham (09905) 6333  
Telex: 858762 ANADEX G

• Circle No. 243

**DON'T WASTE TIME JUST  
READING THIS — ACT NOW!!**

LET US TAKE CARE  
OF YOUR  
GROWING REQUIREMENTS FOR  
MANAGEMENT INFORMATION  
AND OPERATIONS CONTROL



SYSTEMS FOR ACCOUNTING  
YOUR PAYROLL COMPUTERISED  
STOCK CONTROL  
TAILORED SOFTWARE  
ESTIMATING AND COSTING  
MANUFACTURERS' CONTROL SYSTEMS  
SPECIALISTS' SYSTEMS eg.INS./EST.AGT. etc.

DECISION MAKING TOOLS  
ECONOMIC ADVICE — FREE IN FACT!  
SIMPLE AND EFFICIENT OPERATIONS  
INDEPENDENTLY RECOMMENDED HARDWARE  
GUARANTEED RESULTS  
NOW — LET US SOLVE YOUR PROBLEM!!

CONTACT US  
WE HAVE IT ALL — SO WHY NOT USE IT!!  
Logma Systems Design, Whewell Bldgs.,  
2/10, Bradshawgate, BOLTON, Lancs.  
Telephone Bolton 389854

**MICRO & MINI SOLUTIONS**  
eg. **PACKAGES AVAILABLE FROM £3,500**

• Circle No. 244

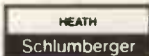

## data systems

wh-19 intelligent terminal **£699** + VAT

- \* dedicated Z-80
- \* 25 x 80 format, upper/lower case
- \* function keys, numeric pad
- \* heavy-duty keyboard
- \* editing, scrolling, addressable cursor

wh-89 integrated computer **£1380** + VAT

- \* all wh-19 features
- \* second programmable Z-80
- \* 16K RAM (expandable to 48K)
- \* 102K mini-floppy drive  
(dual drives optional)

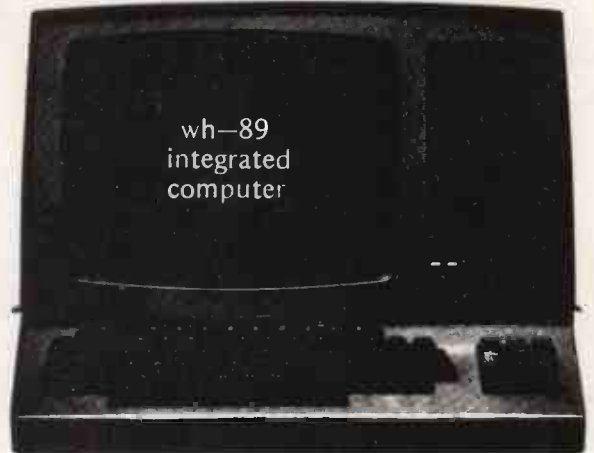

Also available for wh-89: MICROSOFT BASIC and FORTRAN (requires 40K RAM)

MICRONEX provides custom hardware, software and turnkey system specification, design, development, installation and support. Also available: the complete Heath Data Systems range, including the DEC LSI-11 based system; ITHACA DPS-1 (£695); new Apple II plus improved colour (£899); SORCERER (£760); new PET with large keyboard (£630); RICOH RP-40 daisy wheel printer (£1900); and HEATH 132-column dot matrix printer (£510).



**MICRONEX**  
**DATA SYSTEMS**

MICRONEX LTD  
HARFORD SQUARE  
CHEW MAGNA  
BRISTOL BS18 8RA  
027-589-3042

• Circle No. 245

# A PRACTICAL GLOSSARY

Continuing the terminological gamut from O to P

## Operator

Bored, underpaid human with aching back — bad posture for data entry work — and two bad eyes. Also an operator is a symbol denoting a mathematical operation (like + for plus and ÷ for divide) or a logical operation — they vary, but check Boolean algebra for some examples if you're really interested.

## Opm

Operations per minute. A measure used only by appendectomy surgeons, American dp heavies, and glossy compilers.

## Optical character recognition

Recognising characters by looking at them, or rather the machine equivalent. An OCR reader scans the surface of a sheet of paper, analyses the light patterns made by anything printed or written on it, compares that information to a known set of patterns, and transmits to the computer anything it recognises. Some clever OCR systems can recognise handwriting but most can read only typescript in a particular character formation.

Each letter of the alphabet obviously must be identifiably different and this meant that the first standard OCR-readable script — it was called OCR-A — was characterised by ugly blobs and blocks on the letters. Film-makers and advertising agencies like to use this kind of script for the instant connotation of 'computer'. In fact, most OCR uses a much more ordinary, and more readable, script called OCR-B. It looks fairly normal; OCR equipment is becoming more sensitive and more discriminating, so that it can determine finer differences between one character and another.

You can have OCR-B golf-balls for an ordinary Selectric-style electric typewriter, and some printers are available with OCR fonts.

OCR has never really been clever enough, fast enough or cheap enough to replace the keyboard as a way of transferring information from people into computers. In any case, someone probably has to use a keyboard somewhere to create the OCR input in the first place. OCR has found a niche, however, in applications where the alphanumeric input is fairly well standardised and where there is not much of it — for forms, for instance, where many

documents have to be read and input somehow. OMR is simpler, cheaper and generally more useful at this stage of the technology.

## Optimise

Obviously this means to amend something to make sure it performs at maximum efficiency. It's in the glossary because you might find it being applied to computer programs. For instance, an optimising compiler is a *compiler* which does some automatic optimising of your carefully-produced code. There are also special programs called optimisers through which you can run your own code subsequently; they tweak your program a little so that it makes more efficient use of the internal resources available within the computer system.

## OS

Operating system. Several manufacturers have operating systems called — with singular lack of imagination — OS. The big IBM computers are a prime example; so are Interdata minicomputer operating systems.

## Output

As a noun, it's what you get from a computer, sometimes given the blanket term "results". It is also a verb, in which case it means to transfer information from the computer to some kind of clever device — usually a CRT screen or a printer. Less common these days are paper tape or card punches. Esoterica will include graph plotters and electronic gizmos which convert computer data into some near-recognisable representation of the human voice.

## OV

Abbreviation for overflow.

## Overflow

The computer has to assume that internal work areas are a specific size. If it uses a 16-bit word, it probably uses *accumulators* — also called registers — which are eight or 16 or 32 bits long; that way it knows that anything inside that particular string of bits is relevant to the operation in question, and nothing else is. But what happens when the result of an arithmetical operation needs more bits than are in that accumulator? (try dividing 22 by 7).

Well, overflow is what happens.

Your computer might not be able to handle this. Perhaps your accumulator will contain the first eight (or 16 or 32 or whatever) bits of the answer and the rest will be lost. That generally happens in pocket calculators, doesn't it? Perhaps it will round-up the result. Or it might set aside a special 'overflow accumulator' to hold at least some of the overflowing number. Several computers will set a *flag* (qv) to tell you that overflow has occurred, without letting you know where or why.

## Overlay

Overlaying is a popular technique used by the clever kind of operating system for bringing routines, generally called overlays, into main memory from disc or some other kind of mass storage during the execution of a program. With overlaying, several overlay routines can occupy the same main memory storage locations at different times. The technique is used when main memory is not large enough to satisfy total storage requirements of a program.

The other widely-used method in operating systems is *virtual memory*. We shall reach this eventually but basically virtual memory is an automatic kind of overlaying — overlays are specified and controlled by the programmer. In virtual memory systems, the computer pretends to have a larger memory in a fashion not seen by the programmer.

## Over-write

Another obvious one. It means to store information in such a way that it destroys whatever was previously stored there. Since disc, tape and internal computer memory are all re-usable, it follows that re-using them — by storing new information — will over-write their previous contents. One of the virtues of ROM will be equally obvious — you clearly can't over-write anything in read-only memory.

## Pace

An early 16-bit micro from National Semiconductor.

## Pack

Packing is a way of compacting information to economise on storage

space inside a computer. Usually it means lopping-off zeros and omitting spaces in data to be stored, replacing them with some kind of marker which takes-up less space. When the data is read subsequently, *unpacking* takes place and the zeros and spaces are re-instated.

## Package

In electronics, a package is what you have when you embed a *chip* in a block of plastic so that it can be used on a PCB, though that is usually called 'packaging'.

You are more likely to meet this word when it is applied to software; a package is a program developed for a particular application which is designed to be usable by more than one person. This is normal outside computing, of course; you don't often find books designed to be read by only one person. Most applications software is custom-written to suit one user; that is because every computer user has different requirements, even in doing the same basic work.

An application package tries to be all things to all people. Or rather, it tries to be most things to some people. In theory, the user has a tried and tested program which is available more quickly and more cheaply than it would be if it had to be designed and written from scratch and if only he were bearing all its costs.

There have been problems in practice, of course. The package may not be flexible enough to cope with all the idiosyncrasies you require. It was probably written in the first place as a customised job for one user and tweaked subsequently to make its appeal more general. That might not be the best way of producing software; it has to be sufficiently general in its approach to appeal to many users. You may be paying for facilities you will never use and the software may be voluminous and inefficient when it is inside your computer.

The thinking on design of software packages usually means one of two compromises. Either you will amend your ways of doing things to suit the package — quick and cheap; or the package will be capable of amendment, perhaps by being initially a bare-bones framework on to which can be attached some custom-

(continued on next page)

(continued from previous page)

written routines to make it suit you better.

The critical point is economic, particular for business programs. People who can design and develop elegant programs are not inexpensive and they are not common either. Software packages frequently are the only affordable option.

### Packet switching

A clever data transmission process whereby packets or blocks of data are sent on their way with an 'address', rather like ordinary mail. The alternative is more like the telephone system, where a connection has to be established first before any information can pass from one end to the other. Here we are talking about big national or international data communications set-ups, of course.

### Padding

Adding blanks or some other non-significant characters to a record to increase it to a fixed size. It is usually done automatically if the programmer specifies it. Padding will be necessary if you are working with fixed-length records and some contain insufficient data to be processed.

### Page

Either a screen-full of characters — or rather character positions on a VDU: or chunk of storage, usually defined fairly arbitrarily; 512 and 1,024 words are page 'lengths' employed frequently.

### Page printer

Compare *line printers*, which print a line at a time. Page printers generally assemble a page of output in a small internal memory and then put it out very quickly.

### Paging

A facility on some operating systems; a procedure for transferring 'pages' of information between disc storage and main memory. Memory is expensive and you may find you don't have enough of it to hold the programs and data you want. Disc storage is much cheaper and your operating system may allow you to overcome the problem by swapping chunks of information between disc and memory — you are putting part of the current contents of memory temporarily on to disc and reading into the space so freed a piece of program or data you need. As presented, this is *overlaying*; when it is done automatically, it's *paging*.

With paging, pages of memory are

moved in and out at a time. Since this is automatic, the programmer doesn't have to know what is happening and when. To the programmer it looks as though the total memory available is the capacity of main memory plus whatever disc storage there is. That is why paging is also called *virtual memory*.

### Paper tape

Long strips of paper. Usually people mean punched paper tape when they use the phrase, though punching holes in it isn't the only way to store information on paper tape — some esoteric systems print dots on it, impregnate it with chemicals to hold data, and so on.

Punched tape is simple. A single row of holes across the tape encodes one character, rather as on punched cards. Paper tape has one big advantage over card, though — a card normally has room for no more than 80 or 96 characters. Paper tape has no such restriction and you can have blocks of characters up to any length.

You will need the software to cope with that. It is much easier to write programs which expect information in pre-defined record lengths of, say, 80 characters.

Paper tape is cheap, less bulky than cards, and can be read at speeds of up to 1,000 characters per second. No-one uses it much these days, though, because it's messy — all those hole-sized bits of paper fluff — and noisy — a paper tape punch is a fairly crude mechanical device — and you have to buy special hardware — the reader and punch. Cassette or floppy disc are much to be preferred if you can afford them, principally because they are so much faster and are more difficult to tear accidentally.

Two exceptions spring to mind. There are still hundreds of Teletypes around, cheap and noisy terminals which, frequently, have a built-in reader/punch for paper tape, so you might as well use it. Some older high-speed printers also utilise pre-punched paper tape, typically a loop of it; this is being read while the printing is proceeding and it determines vertical format — when to start a new page.

There is one largely-unexplored and extremely flippant use for paper tape, which incidentally is available in several colours. Remember those ticker-tape welcomes in New York City which no longer seem to happen? Well, ticker tape is paper tape from teleprinters and that is the same as a computer's paper tape. □

## COMPLETE COMPUTER SYSTEMS (CCS)

PRESENT

the **ABC 80**

Zilog Z80A microprocessor, the ABC 80's brain.

Professional keyboard of Swedish standard.

12" black-and-white TV screen. Displays capitals and small letters, digits, figures and diagrams. Room for 24 lines of 40 characters each.

Built-in graphic mode. Uses 64 different graphic symbols.

Program memory. 16 K BASIC of ROM, 16K bytes of RAM. 2K Monitor In ROM. 1K Picture RAM.

Loudspeaker. 128 different sound effects. Can be used to provide alarms or other signals.

Cassette memory for storing programs and data. Fast winding in both directions.

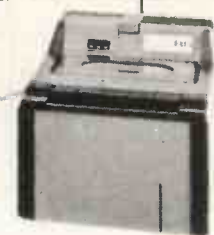

Built-in real-time clock for timing.  
price £759.00 (provisionally).  
Available from U.K. importers

CCS MICROSALES  
22 WESTSIDE  
68 FORTIS GREEN  
LONDON N2 9EN  
Tel: 01-444 7739

V-24 jack for connecting to a telephone modem so that you can communicate with other computer systems via the public telephone network.

46/80 Bus for connecting peripherals such as floppy-disk units, printers, plotters, measuring instruments etc.

### CCS Microhire

Still the Leading Micro-computer Hire Company with the best range of equipment: APPLE and PET prices down now. PET 8K £4.20 per day\* 16K APPLE £5.70 per day\*. Apple II; PET; Exidy Sorcerer; SEED System One/MSI 6800; NASCOM/MICROS; Research Machines 380Z and Tandy TRS-80.

Over 500 million Bytes (half megabytes memory) available for hire in units from 4K to 48K.

\* FOUR DAY RATE.

Send for our NEW PRICE LIST giving the most attractive prices yet.

and CCS MICROHIRE  
FREEPOST (soon at 7, The Arcade)  
LETCWORTH  
HERTS SG6 4YA



# INTEGRATED SMALL BUSINESS SOFTWARE

## - ISBS -

FAST AND EASY TO USE ISBS MEANS INCREASED EFFICIENCY AND PROFITABILITY - PUT IT TO WORK FOR YOUR BUSINESS

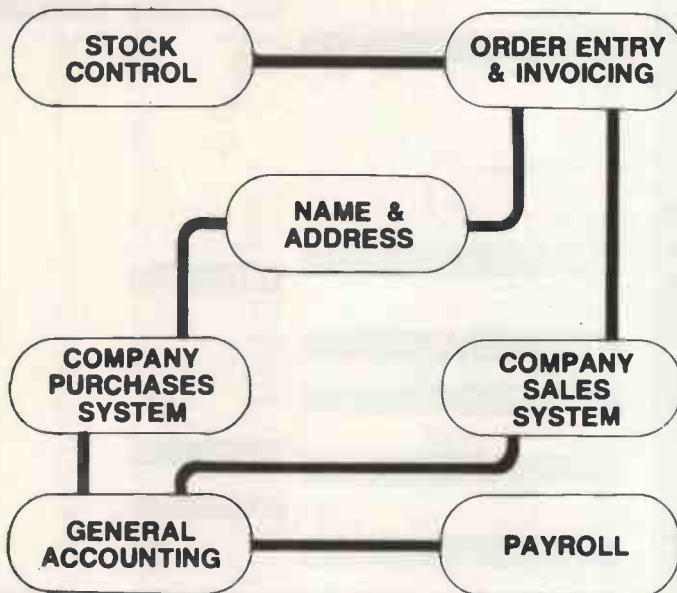

### ISBS

	£
STOCK CONTROL	350
ORDER ENTRY & INVOICING	350
NAME & ADDRESS SYSTEM	250
COMPANY PURCHASES SYSTEM	450
COMPANY SALES SYSTEM	450
GENERAL ACCOUNTING	400
PAYROLL	500

Packages supplied on floppy disk with easy to follow Reference Manuals — NO PREVIOUS COMPUTER KNOWLEDGE REQUIRED TO OPERATE. ISBS runs on 48K Northstar Horizon, Rair Black Box or other systems supporting CP/M\* — plus VDU and 132 col printer. Complete suite or individual packages available now and are fully supported.

Other software packages available include Time Recording Systems, Finance Control and many others. Special application software undertaken for Northstar & Black Box and also complete TURNKEY SYSTEMS.

\*CP/M registered trademark of Digital Research.

Costs shown exclusive of VAT.

Dealer enquiries welcome.

# GRAFFCOM

52 SHAFTESBURY AV. LONDON W1.

01-734-8862

• Circle No. 248



## New Bear Systems



WE SPECIALISE IN:—

### APPLE II

FROM £810.00

- ★ PURCHASE LEDGER . . . . . £295.00
- ★ SALES LEDGER . . . . . £295.00
- ★ GENERAL LEDGER . . . . . £295.00
- ★ WORD PROCESSING . . . . . £ 50.00

LEDGER MANUALS AVAILABLE SEPARATELY @ £10.00 EACH

## NORTH STAR HORIZON

- HRZ-2-32 32K + DUAL DISK DRIVE . . . . . £1480
- HRZ-1-16 16K + SINGLE DISK DRIVE . . . . . £1135
- CP/M FOR HORIZON . . . . . £ 115
- PASCAL FOR HORIZON . . . . . £ 70

## DPS-1 THE ITHACA INTERSYSTEMS S100 MICROCOMPUTER

For education, industry, research and all professional uses, including hardware and software development, low cost OEM Systems, teaching applications etc.

- ★ Mainframe with front panel
- ★ 30 Amp 8v power supply
- ★ 20 slot motherboard with active termination and shielding between bus lines
- ★ Guaranteed operation at 4MHz

Price with 4MHz Z80 CPU Board . . . £ 695

Please send for details of the full range of Ithaca Intersystem S100 products.

+ FULL RANGE OF VDU's AND PRINTERS

### HEAD OFFICE & MAILORDER:

40 Bartholomew Street, Newbury, Berks.  
Tel: 0635 - 30505 Telex: 848507 NCS

### NORTHERN SHOWROOM:

220-222 Stockport Road, Cheadle Heath, Stockport.  
Tel: 061-491 2290

### TERMS

Official Orders Welcome.

Please add 15% VAT on all prices.

Barclaycard and Access Welcome.

Send or Phone (0635-30505) for Catalogue and Booklist.

• Circle No. 249

# SOFTWARE FOR TRS-80 Level II 16K

## CASH/BANK ANALYSIS

A really practical program designed by accountants to take the drudgery out of incomplete records.

Cassette and superb Operation Manual **£46.00**

## VAT REGISTER

Input and output Register.

Cassette and Manual **£17.25**

## SMALL TRADERS SPECIAL VAT SCHEME "D"

Turn a nightmare into a dream with our program. Output, retailing and non-retailing input Registers. Performs the special Scheme "D" calculations and prints the summary.

Cassette and Manual **£23.00**

## ONE FOR THE CHILDREN

Even in this exciting computer age, teachers agree that **TABLES STILL MATTER!** Our teach yourself tables program, devised by a teacher makes it fun. Just **£5.75**

## CLOADING PROBLEMS ?

Perhaps it's the azimuth adjustment. This is the angle of the record/playback head, which should be precisely perpendicular to the motion of the tape. It very often isn't, and then troubles start. Check the alignment with our special high frequency test tape. Complete with instruction sheet. **£4.60**

## SOMETHING COMPLETELY DIFFERENT

Not a program but an audio tape. "The Petrol Saver" dozens of hints and tips on saving fuel, which means saving cash. **£3.45**

(NOTE: Analysis, VAT, and Scheme D require Line Printer)

All prices include VAT and post and packing. Programs written to order.

High speed cassette duplication (Customers must produce evidence of Copyright)

(Callers by appointment only please)

**Alan Ford + Company**  
PHOENICE HOUSE, GREAT BOOKHAM, SURREY

• Circle No. 250

# CHROMASONIC electronics

your soundest connection in the world of components

Dept PC, 56 FORTIS GREEN ROAD, MUSWELL HILL, LONDON, N10 3HN  
TELEPHONE: 01-883 3705/2289

## DYNAMIC RAMS

DYNAMIC RAMS	1+	8+	16+
4027	£3.46	£3.16	£2.86
4116 (250 ns)	£8.03	£7.30	£6.57
4050 (200 ns)	£3.16	£2.87	£2.58
4050 (350 ns)	£2.91	£2.70	£2.43
4060 (300 ns)	£2.97	£2.75	£2.47

## STATIC RAMS

STATIC RAMS	1+	16+	64+
2102A	£1.33	£1.19	£1.04
2102A-2	£1.19	£1.04	£0.93
2111A-1	£1.95	£1.75	£1.58
2112A-2	£2.11	£1.93	£1.80
21L02	£1.33	£1.19	£1.04
MM 5257 (TMS 4044)	£7.97	£7.37	£6.90
MM 2114	£7.97	£7.37	£6.90
MC 6810	£3.48	£3.08	£2.68
4035 (1000 ns)	£1.23	£1.14	£1.02
4045 (250 ns)	£7.07	£6.55	£5.89

## ROMS

2513 (Upper Case)	£7.18
2513 (Lower Case)	£7.18
MM 5230	£5.31

## MEK

6800 D2 (KIT)	£195
---------------	------

## BAUD RATE GENERATORS

MC 14411	£6.33
MM 5307	£10.49

## CPU E-PROMS

8080	£ 5.84	1702 AQ	£ 5.93
6800	£ 6.91	2708 Q	£ 7.20
9900	£29.95	2716	£27.59

## T.V. CONTROLLER

SFF 96364	£16.77
-----------	--------

## UARTS

AY-5-1013	£4.20
MM 5303	£5.79

## BUFFERS

181LS95	99p	74L 500	.20p
95	80p	01	.20p
97	99p	04	.22p
98	80p	05	.22p
SN 74365	60p	08	.21p
66	60p	14	.84p
67	60p	28	.22p
68	60p	30	.21p
8T 26	£2.80	51	.21p
28	£2.80	76	.31p
8T 95	£1.80	78	.31p
96	£1.80	95	.93p
97	£1.80	126	.41p
98	£1.80	151	.93p
		155	.83p

## INTERFACE

8205	£3.45	160	£1.06
8212	£2.31	163	.69p
8216	£2.39	166	£1.50
8224	£3.82	170	£1.76
8228	£5.41	192	£1.97
8251	£6.12	193	£1.97
8253	£7.97	194	.75p
8255	£5.84	195	£1.12
		197	£1.12
		221	£1.06
		253	£1.06
		279	.51p

## L. SERIES

74L 90J	£2.59	283	£1.06
		293	.89p

## S. SERIES

74 S00	£0.65p	348	£1.15
74 S387	£2.68	365	.54p
74 S474	£12.93	366	.54p
74 S262	£12.00	368	.54p
		393	.97p
		668	£1.38

BARCLAYCARD

VISA

Postage and Packing 25p. Trade and Export Inquiries most Welcome. Hours 9.00am - 5.00pm. Now available our ORDERING line, just phone your order through with your Access or Barclaycard number and providing the order is received by 3.00pm the components will be despatched the same day (min tel order £5.00).



• Circle No. 251

# MICROTEK COMPUTER SERVICES

FOR:

## EQUINOX 300 NORTH STAR HORIZON IMS 5000

PLUS:

DIABLO, ELBIT & TEXAS PERIPHERALS.  
SOFTWARE PACKAGES FOR:

STOCK CONTROL  
ACCOUNTING AND VAT  
CLIENT INFORMATION & MAILING  
BUDGET CONTROL  
CAR STOCK BOOK  
IMPORT CONTROL  
PAYROLL  
'LOCATE-A-CAR' SYSTEM, ETC.

50, Chislehurst Road, Orpington,  
Kent.

Tel: Orpington 26803

• Circle No. 252

# We've pioneered the west!



We've opened up the west of London and if you're local to the Ealing area that can only be good news for you.

We stock all the big names - Commodore, PET, Apple and Nascom.

We have the knowledge and expertise to provide a software package or business system that's right for you plus a comprehensive maintenance and engineering back-up service.

Call in for more information or a demonstration.

(We also sell a wide range of tapes and books.)

Adda Computers, 17-19 The Broadway, Ealing, London W.5.  
(between W.H. Smiths and Burtons)

Telephone 01-579 5845

Open 09.00-18.00 Monday to Friday;

10.00-16.00 Saturdays.

**adda** we add up to a great deal.

• Circle No. 253



## CENTRALEX LONDON

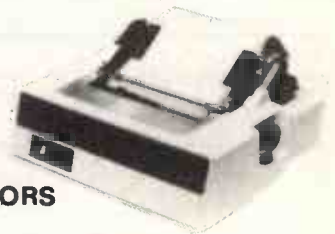

### TRANSLATOR

An instant translator of words and phrases from the world's major languages.

Use this amazing Hand Held Microcomputer translator as a

- Personal interpreter when you travel
- Quick reference to most often needed phrases
- Metric system converter
- Calculator

Basic Unit £170 (including six languages, re-charger, and carrying case). Each additional Language Module (for more extensive vocabulary) £34 - French, Spanish, Italian, Greek & German. Calculator Module £24.

The above prices include VAT and delivery nationwide.

### MICROCOMPUTERS

APPLE  
EXIDY SORCERER  
ITT 2020  
HORIZON



Full support for Hardware and Software.  
Twelve months parts and labour guarantee.  
Maintenance contracts.  
Part exchange welcomed.

### PRINTERS & VIDEO MONITORS

Printers:

- \* Centronics
- \* Integral

- \* Anadex
- \* Teletype

Video Monitors:

- \* Hitachi

- \* Sanyo

### SOFTWARE- PROGRAMMING-TRAINING

#### Software

A comprehensive range of programmes and software packages are available (Sales Ledger, Purchase Ledger, Payroll, VAT, Data Base System, Word Processing, COBOL, Fortran, Stock Control, Medical Records, Educational Programmes, Estate Agents, Hotel Reservation System, School Administration, Building Maintenance, Project Management, Statistical, Mathematical, and Engineering Programmes, etc)

#### Programming

Systems Analysis, Design, and Programming support available.

#### Training

Courses on Microcomputer Appreciation, Programming, and Systems Design are frequently held.

**Free Delivery Nationwide - Credit Cards Accepted - Terms Arranged**

Centralex-London Ltd, PO Box 111, Sidcup, Kent DA15 7NY (Callers by appointment only)

Telephone: 01-309 7799 01-300 0380

• Circle No. 254



**APPLE II EUROPLUS IS AVAILABLE NOW, AT A BIG SAVING, FROM**

## Microware Computers

1133 HESSLE HIGH ROAD HULL HU4 6SB  
Telephone (0482) 562107

# APPLE II

16K RAM ~~£830~~ **£750**  
+ VAT



take a fresh bite  
at the APPLE II

(DELIVERY CHARGED AT COST)

**ALSO PET AND MICROSTAR MAIN DEALERS**

• Circle No. 255

## SIRTON PRODUCTS

13 WARWICK ROAD  
COULSDON  
SURREY Tel: 01-660 5617



### MIDAS S100 SYSTEMS

Substantial Mainframe to house your S100 system, with optional 5in. or 8in. disc drives. Special systems built to your requirements from Z-80 CPU and other S100 boards held in stock.

Mainframes from £228

MIDAS 1 : Z-80 System from £625 (built)

MIDAS 2 : Z-80 5in. Disc System from £1,100 (built).

MIDAS 3 : Z-80 8in. Disc System from £1,300 (built).

### ITHACA INTERSYSTEMS DPS 1

Professional versatile computer system with comprehensive front-panel facilities and 20-slot motherboard. Units have substantial power supply etc. and come with 2 or 4 MHz Z-80 CPU. BUS conforms to the IEEE S100 standard.

DPS.1 from £695



**COMPREHENSIVE RANGE OF S100 BOARDS AND SOFTWARE STOCKED**

*from*

ITHACA INTERSYSTEMS · S D SYSTEMS · GODBOUT · CROMEMCO ·  
ECT · S S M · Etc

Write or Phone for Catalogue



• Circle No. 256

# WORD PROCESSOR COMPLETE WITH PRINTER FOR £1,195

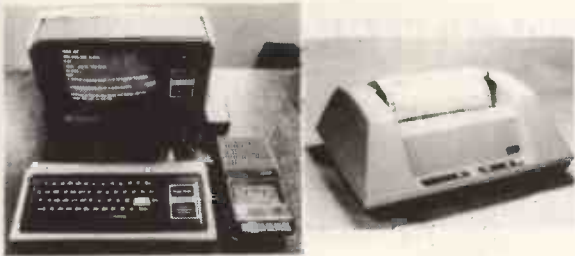

Based on TRS-80 Level II, 12in. wide screen, 64 characters (A4) wide, upper/lower-case, superb Electric Pencil software, Anadex 8000 dot matrix printer or Qume daisywheel printer (option).

General business software also available to run on the above system.

Complete with Anadex printer 16K	£1,195
As above with expansion box & 48K	£1,445
Qume daisy printer in lieu Anadex	£995
Dual floppy disc drives	£575

All prices ex. VAT.

Phone/write for further details or demonstration.

**LONDON COMPUTER STORE**  
43, GRAFTON WAY, LONDON W1.  
Tel. 01-388 5721.

• Circle No. 257

# EQUINOX 300

A powerful multi-user  
multi-tasking  
multi-language

16-bit microcomputer time-sharing system

- supporting
- BASIC
  - LISP
  - PASCAL
  - Floppy discs
  - Hard discs

including a powerful Text Formatter,  
Assembly Language Development System  
and disc-based Sort utilities.

Priced from under £5,000

Write or phone for further information.

## EQUINOX COMPUTER SYSTEMS LTD

"Kleeman House" 16 Anning Street,  
New Inn Yard, London EC2A 3HB.  
Tel: 01-739 2387/9. 01-729 4460.

• Circle No. 258

If you are looking for amusement arcade type games, with lots of bangs, flashes and aliens — our software is definitely not for you!

## Games for Super Intelligent People!

Our Games require thought, imagination, intelligence and creativity. If you want your mind stretched — look no further!

"*Eleusis*" is a card Game unlike any other. It involves your skills of inference, and makes such Games as Mastermind, simple. With over 100 variations, this game will "stretch" you over the winter (£15)... "*Sucker*" is a Game you have never seen before ... with equal chances, the computer will beat you in prediction ... you will have to be good to discover how ... exceptionally good to work out why! (£10). "*Anticipation*" is a new card Game involving strategy for between 1 and 3 players. Very exciting and elegant (£10). We have a range of Business Games, suitable for PET, APPLE 11/ITT 2020 and TRS-80 (II) ... write now for more details.

## Training modules

We have a wide range of training modules on cassette ... "*Break-even*" teaches the fundamentals of *Break-even Analysis* (£10) ... *Management Activity Analysis* (£10) enables you to compare your own work pattern and attitudes with those of other professionals ... *Management Style Orientation* (£10) gives you an in-depth look at the way you supervise others ... *Interpersonal Orientation* (£15) is a very detailed analysis of your strengths and weaknesses in relation to other people. (All prices include VAT + P&P).

## Business Applications

If you advertise and sell  
"off-the-page" or use Direct  
Mail, our AMORE program  
is certainly going to interest  
you. Simply write for details.



PET  APPLE II  TRS.80

### ENCLOSE:

CHEQUE/POSTAL ORDER NO.....  
BARCLAYCARD NO.....  
ACCESS CARD NO.....  
NAME.....  
ADDRESS.....

PLEASE  
SEND ME:

**Rathlin Island Software,  
Ulster Management Centre,  
Manor House, Rathlin Is, Co Antrim**

• Circle No. 259

# GILBERT COMPUTERS

Gilbert Computers believe in the NEW **SHARP** MZ THE

- IMPECCABLY-ENGINEERED
- MODESTLY-PRICED
- BIG-HEARTED, COMPLETE MICROCOMPUTER

It is what we, and you, have been waiting for to solve the problems of the smallest business. You will be able, without specialist knowledge, to quickly and effortlessly handle your stock control; accounting; VAT records; invoicing and other chores.

This, too, from the equally exciting

## COMPUCOLOR II

with its dazzling colour graphics.

... And they can both be absorbing and educational.

Give your children the tools of the future.

Provided locally from centres in Market Harborough and Swindon by Gilbert Computers the ONLY suppliers offering these AND

- \* FREE initial demonstration and explanation at your office, shop or home with no pressure to buy
- \* Inexpensive tailor-made program service
- \* Equipment maintenance contracts available
- \* Credit facilities

*Call or write for further details*

## GILBERT COMPUTERS

Old Hall Lane,

Lubham, Leics. LE16 9TJ 0858-65894

• Circle No. 260

# Cassette Duplicating Supplies

Blaylynn Ltd.

OFFER YOU A COMPLETE  
RANGE OF

## COMPUTER CASSETTES

Any Length Produced to Order

Any Quality Supplied

With or Without Labels or Cases

Top Quality Guaranteed

REALISTIC PRICES

10 C12 for 18.0p each

100 C12 for 16.5p each

Contact

FRANK WHIPP

Tel: 01 - 540 0707

● ○ ○ ○ Sales Office:-  
○ ○ ○ ○ Suite 6, 2nd Floor  
○ ○ ○ ○ Broadway House  
○ ○ ○ ○ The Broadway  
○ ○ ○ ○ Wimbledon  
○ ○ ○ ○ London SW19 1RH

• Circle No. 261

# Mind your own business...

## ...with a Bondain Book-keeper.

The Bondain Book-keeper brings big business benefits without breaking budgets.

Whatever your problem we've got a complete solution you can afford.

The Bondain Book-keeper includes complete systems for Stock-Control, Invoicing, Sales Ledgers, Statement Preparation, Debt Dating, Purchase and Nominal Ledgers.



Total cost  
under £2000  
a year.

Head Office:  
Sumlock-Anita House  
15 Clerkenwell Close  
London EC1R 0AA.  
Tel: 01-253 2447/8  
Telex: 299844

SEE US AT THE  
INTERNATIONAL  
BUSINESS SHOW  
OCT 23rd - NOV 1st  
NEC BIRMINGHAM  
HALL 2 STAND 739

SUMLOCK



BONDAIN

• Circle No. 262

# Get it right...

The right machine **PET**

The right programs

## Computastore

**PAYROLL** This flexible PAYROLL system makes wage calculation fast, easy and accurate. It prints payslips, totals, coin analysis, and year end totals. Updates for tax and NI changes available.

**PETE** Go on-line with this unique software package which turns your PET into an intelligent RS-232 terminal with user definable transmission parameters.

**ASSEMBLER** Really fast Assembler written in machine code, assembles up to 500 lines per minute on the Commodore Disk. It allows 200 symbols on an 8K PET (1000 on larger PETs).

**DISASSEMBLER** Can even display the PET's ROMs, and search them for strings of characters or patterns of hexadecimal bytes. Outputs to screen or printer.

**KEYBOARD** Big keyboard terminal or printer (e.g. TTY 43) can now be used as a dumb terminal for keying in BASIC programs or data for your PET. The PET can even be in a different location! Also, speeds up data entry for 8K PET owners with keyboard/printer.

Cassette and Commodore Disk versions available for old and new ROM PETs.



## Computastore

Software that means business

Ask your local PET dealer or Computastore for a demonstration

Computastore Ltd, 16 John Dalton Street, Manchester M2 6HG Tel: 061-832-4761.

● Circle No. 263



## HOW TO SOLVE SYSTEMS PROBLEMS WITHOUT HAVING TO WATCH YOUR LANGUAGE ZILOG'S MCZ FAMILY. FROM AROUND £4000

The MCZ computer family using Zilog's famous Z80 CPU can solve your problems (or your customers' problems) more efficiently and economically than ever before. Just look at what Zilog offer.

To start, the Zilog system is multi-lingual. Every model has a full five language capability. You can move your programs in any language up and down the family at will.

*Pascal.* Rapidly becoming a favourite.

*Cobol.* For business use — and it's the highest level implementation of Cobol available on a computer in this price range.

*Fortran.* Outstanding performance for scientific use at an attractive price.

*Basic.* Zilog's version has been extended for both business and scientific applications.

*PLZ.* Zilog's own family of systems implementation language.

The key to the MCZ family's success is it's RIO operating system with features normally found only on very high priced computers.

- ★ Device Independent I/O
- ★ Mid-file record insertion or deletion
- ★ Interactive and batch command input
- ★ Full set of utilities
- ★ Macro assembler
- ★ Text editor

The range includes the MCZ 1/05 — a low cost floppy disk model, the table-top MCZ 1/20 or MCZ 1/25 rack mounting floppy disk computers and the highest performer, MCZ 1/35 cartridge disk version with 10 MBytes of storage.

Zilog UK Ltd, Babbage House, King Street, Maidenhead, Berks. Tel: Maidenhead (0628) 36131. Telex: 848609.

Software packages available now include order entry, payroll, purchase, sales and nominal ledgers, stock control, formatting and many more.

To back this up, Zilog offer full maintenance on software and hardware.

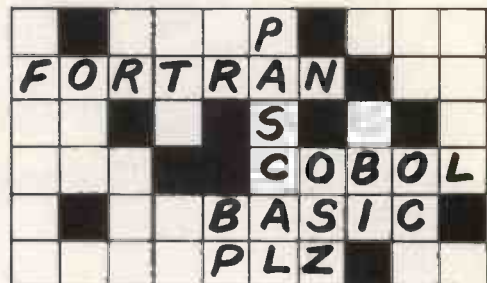

For full details of all you need to stay well ahead in tomorrow's world, call Zilog. Now.



Welcome to tomorrow's world

• Circle No. 264



**Sumlock**

Manchester

Sumlock Electronic  
Services (M/cr) Ltd.

Petsoft and Commodore Software Stockists

Pet	Price	Availability
2001-4	£460.00	Current
2001-8	£550.00	Current
2001-16N	£675.00	Current
2001-32N	£795.00	Current

Petact business programs demonstrated during business hours



Plus all these add-ons for your PET 2001

**Printers**

Teletype 43 with keyboard	£995.00	Current
Teletype 43 without keyboard	£970.00	Current
PET 2023	£550.00	No further orders
PET 2022	£645.00	Orders accepted
ANADEX with PET interface	£700.00	Current

**Floppy Disk Unit**

PET 2040	£795.00	Current
DISKMON	£840.00	Current
24K Memory Expansion for Diskmon	£320.00	Current

**External Cassette Deck**

C2N	£ 55.00	Current
PET DUSTCOVERS (Plain)	£ 6.00	Current
PET DUSTCOVERS (Printed)	£ 6.50	Current

*(Commodore Approved)*PET/BASIC training manuals available from £3.00  
Sumlock printer interface IEEE to RS232c from £100.00

• Circle No. 265

## Personal Computer World Show

# MEET THE LITTLE GENIUS AT STAND A9

If you find self-instruction manuals difficult to follow, come and meet our Little Genius.

Little Genius floppy diskettes are the fastest, easiest way to master your micro.

Little Genius will save you time and effort, teaching you to exploit all your micro's facilities.

For a free demonstration of our first two courses visit Stand A9 at the PCW Show or phone Peter Brown on 01-580 6361.

• Circle No. 266

## INTEX DATALOG LTD AGENTS FOR:— COMMODORE COMPUTHINK APPLE II PETSOFT

**\*\*\* PET MICROCOMPUTER**

2001-4	£ 460.00
2001-8	£ 550.00
2001-16N	£ 675.00
2001-32N	£ 795.00

**\*\*\* KIM MICROCOMPUTER**

KIM 1	£ 99.95
KIM 3B	£ 129.95
KIM 4	£ 69.95

**\*\*\* CASSETTE DECKS**

PET C2N	£ 55.00
---------	---------

**\*\*\* FLOPPY DISKS**

CBM 2040	£ 795.00
COMPUTHINK 400K (OLD ROMS)	£ 795.00
COMPUTHINK 400K (NEW 16K)	£ 840.00
COMPUTHINK 800K (NEW 16K)	£ 995.00

**\*\*\* MEMORY EXPANSION**

EXPANDAPET 24K	£ 320.00
----------------	----------

**\*\*\* PRINTERS**

PET 2023	£ 550.00
CBM 3022	£ 645.00
ANADEX DP8000	£ 575.00
TELETYPE 43—WITH KEYBOARD	£ 875.00
TRENDCOM 100 (INTERFACE EXTRA)	£ 243.00
CENTRONICS 779	£ 885.00
AXIOM MICRO PRINTER	£ 369.00
AXIOM GRAPHICS PRINTER	£ 749.00
TEXAS 810 — FROM —	£1450.00
QUME SPRING KSR45 — FROM —	£2384.00

**\*\*\* CABLES ETC.**

IEEE TO PET CABLE	£ 20.00
IEEE TO IEEE CABLE	£ 25.00
DUST COVER	£ 5.75
NEW ROM SET FOR 8K	£ 35.00
TELETYPE 43 RIBBON	£ 7.72
ANADEX DP8000 RIBBON	£ 4.50
PR-40 RIBBON	£ 5.00

**\*\*\* APPLE MICROCOMPUTER**

16K APPLE	£ 830.00
32K APPLE	£ 920.00
48K APPLE	£1010.00

**\*\*\* ADDITIONAL MEMORY**

16K BLOCK	£ 90.00
-----------	---------

**\*\*\* ROM ADDITIONS**

APPLESOFT	£ 110.00
PROGRAMMERS AID	£ 40.00

**\*\*\* FLOPPY DISK**

SHUGART 5 1/4in 116K CAPACITY	£ 425.00
-------------------------------	----------

**\*\*\* ACCESSORIES**

CARRYING CASE	£ 25.00
---------------	---------

**\*\*\* INTERFACES**

TV/VIDEO INTERFACE (PET)	£ 35.00
BAILEY OMNI-DIRECTIONAL (P)	£ 106.00
BAILEY BI-DIRECTIONAL (P)	£ 106.00
BAILEY BI-DIRECTIONAL (P)	£ 186.00
BAILEY PARALLEL (P)	£ 45.00
TNW 2000 BI-DIRECTIONAL (P)	£ 175.00
TRENDCOM (P/A)	£ 49.00
LIGHT PEN (A)	£ 155.00
PRINTER OR SERIAL CARD (A)	£ 110.00
CENTRONICS PRINTER CARD (A)	£ 125.00

**\*\*\* DISKETTES**

SINGLE SIDED S/D (BOX 10)	£ 30.00
DOUBLE SIDED D/D (BOX 10)	£ 35.00
DISK LIBRARY CASE (HOLDS 10)	£ 3.15

**\*\*\* CASSETTE TAPES**

C-20 BLANK CASS IN CASES	£ 40
--------------------------	------

**\*\*\* PAPER**

TRENDCOM ROLL PAPER	£ 2.50
80 COL. (ANADEX/CENT.)	£ 15.00
132 COL. (TELETYPE 43)	£ 26.00
AXIOM ROLL PAPER	£ 5.70
PR-40 ROLL PAPER	£ 1.00

**\*\*\* MANUALS**

TIS WORKBOOKS (SET 6)	£ 18.00
-----------------------	---------

\*\*\*\*\*

PLEASE ADD 15% VAT TO PRICES SHOWN  
(UNLESS MANUALS)  
\*\*\*\*\*

INTEX DATALOG LIMITED,  
EAGLESCLIFFE INDUSTRIAL ESTATE,  
EAGLESCLIFFE,  
CLEVELAND,  
TS16 0PN.  
TEL. 0642 781193  
TELEX 58252

• Circle No. 267

# U. K. — Micro Supplies — SCOTLAND 03374-795

## FLOPPY DISCS MICROPOLIS

1041-11 315K drive + controller Cable + BASIC, ASSEMBLER, + EDITOR only	£595.00
1015-11 315K drive — add-on other products on application	£395.00
DS525-10 Pack of 10 5¼ in. floppy disk	£29.00

## S100 BOARDS

SD Sales 32K Ram 375 ns Assm. +tested	£355
JADE Z80 2 mhz Assm. +tested	£140
MIKOS 15 slot Mother Board Assm. +tested	£110
MIKOS 2 Parallel/2 Serial Assm. +tested	£130
MIKOS 16K Erom (No 2708's) Assm. +tested	£110
MIKOS Extender Board Assm. +tested	£47
MIKOS Real time clock 2 interrupt Assm. +tested	£120
DSEL P.S.U. Kit +8v ±16v 4A Assm. +tested	£175

## V. D. U. s LEAR SIEGLER

ADM 3A Introductory Offer	£550.00
Hard disks 5-36 M6 POA	
Volume discounts *special offer*	

## SOFTWARE

CP/M for Micropolis	£90
MACRO for above	£60
TAILORED Software for all applications	

## PRINTERS CENTRONICS

Centronics 779	£750.00
Centronics 701	£1210.00
Centronics 703	£1894.00

## SYSTEMS

U.K. DISTRIBUTOR for  
SDS-200 (SD Sales) also HORIZON,  
CROMEMCO, DATA SYSTEM 800, 801

### FULL SERVICE & BACK-UP FACILITIES AVAILABLE

Telephone for all Non-Listed items  
OEM & DISCOUNTS on Application

ACCESS BARCLAYCARD  
Delivery at cost — Prices exclude VAT

## DATA SYSTEMS SUPPLIES LTD.

SHORE HEAD ROAD, INDUSTRIAL ESTATE,  
NEWBURGH, FIFE, SCOTLAND.

# 03374-795

• Circle No. 268

# Micro-Facilities

127 High Street  
Hampton Hill  
Middlesex TW12 1NJ

01-979 4546  
01-941 1197

## MIDDLESEX & SW LONDON

As dealers for North Star Horizon and Commodore PET Microcomputers we provide a fully comprehensive service for all types of user:

★ Personal ★ Business ★ Education ★ Industry ★ Scientific  
We offer both a large range of software and the choice of supporting peripherals.

### Software Packages

Sales Ledger Purchase Ledger  
General Ledger Stock Control  
Incomplete Records  
Loan Accounting Mail Order  
Payroll Job Costing  
Text Processing CP/M

### Systems & Programming

A professionally experienced team of consultant analysts and programmers offer you a complete service for specifying, designing, writing and testing programs to your exact requirements. Our packages can be tailored to your needs at

very low cost. Our programmers can write in BASIC, COBOL, RPG, or FORTRAN.

### Financing

In addition to purchasing, we offer you the choice of Rental, Leasing or H.P. (subject to references). Furthermore if you already have a micro system then why not ask us about part exchange. Commodore PET computers are available for hire from £4.75 per day, disks interfaces and printers are extra.



NORTH STAR HORIZON



COMMODORE PET

If you have a computer problem then ask Micro-Facilities for the solution.



Association of Independent  
Computer Specialists

• Circle No. 269

# DATA PRECISION (Equipment) Ltd.

proudly present

## THE VIDEO KEYBOARD



- 72 key ultra-reliable contactless capacitive keyboard with cursor command keypad
- RS 232/V24 serial I/O up to 9600 bauds
- Composite video output for monitor or modified TV
- Built-in mains power supply

*Although low-cost, the Video Keyboard is OEM built in the UK using only top-quality components. Other low-cost products use cheap, low MTBF contact-switch keyboards. The Video Keyboard uses the same professional quality ultra-reliable contactless keyboard used by top-flight UK terminal manufacturers.*

### DETAILED SPECIFICATION MODEL VDP 10

#### VIDEO

- One page memory  
64 characters per line 16 lines per page
- Full 128 ASCII character set  
96 upper and lower case characters 32 control symbols
- Comprehensive cursor controls  
Left/right/up/down CR/LF Clear/home/line-erase
- PROM translation of inbound characters, giving:-  
Programmable coding for cursor commands  
Programmable display control for each input code
- Cursor command codes can be displayed using:-  
'Display' key for protocol debugging V24 input bit 8 under remote software control
- European compatible composite video out for:-  
TV monitor, or Modified TV set.

#### V28 I/O

- High/low rates externally switchable and jumper selectable from:-  
9600/4800/2400/1200/600/300/150/75 bits/sec.  
220/110 bits/sec. (NOTE: at high receive speeds, remote software should allow 8.3 ms for CR, LF and 132 ms for Clear)  
Odd, Even or No Parity Full duplex or local mode  
One or two stop bits V24 serial I/O using standard 25 pin socket

#### KEYBOARD

- 72 key ultra-reliable solid state contactless keyboard
- Standard ASCII layout plus programmable cursor control keypad
- QWERTY standard
- Full N key rollover
- Caps Lock with LED for TTY compatibility
- Repeat key.

#### MAINS POWER SUPPLY

- Built-in - needs 220-240V 50Hz.

#### CABINET

- Tailor-made to house all electronics, keyboard, video and V24 sockets, switches and power supply.

#### SWITCHES

- Power on/off
- On-line/Off-line
- Baud Rate Select  
Medium/High/Low Normally set to 9600/1200/300
- Display Key  
Displays control characters for easy protocol debugging

AVAILABLE IN TWO VERSIONS (Monitor/converted TV not included).

Complete Video Keyboard . . . . £230+VAT (UK p&p paid)  
Stripped Video Keyboard . . . . £190+VAT (UK p&p paid)  
[stripped version excludes case, case hardware (switches, plugs), 240/9-0-9 VAC transformer but otherwise complete and tested].

Both versions are brand new with comprehensive manual and 12-month warranty.

#### DATA PRECISION (Equipment) LIMITED,

81 Goldsworth Road, Woking, Surrey GU21 1LJ

Tel: Woking 64444/67420

Reg. in England No. 913775

Please send me:

- .... Complete Video Keyboards @ £264.50 each, inc. VAT and UK postage and packing
- .... Stripped Video Keyboards @ £218.50 each, inc. VAT and UK postage and packing
- .... Video Keyboard Manuals @ £2 each, inc. postage and packing (free with Keyboard)

I enclose my cheque

Charge to my VISA/ACCESS/DINERS Card  Not VISA



Name .....

Address .....

Signature .....

**TVJ**

For Hardware, Software, Peripherals, Consultancy and Competitive Prices.

# MICROCOMPUTERS ETC

Registered business name

CAMBERLEY (0276) 62506  
BRISTOL (0272) 422061  
OXFORD (0865) 721461



## PET Pet 2001 From £435

NEW PET 2001 with large keyboard.  
From £ 630.00



PET 2001-16N (16K RAM and New Large Keyboard)	£630.00
PET 2001-32N (32K RAM and New Large Keyboard)	£750.00
PET 2001-4 (Standard PET with 4K memory)	£435.00
PET 2001-8 (Standard PET with 8K memory)	£515.00
PET 2040 (Dual Drive mini-floppy 343K User Storage)	£745.00
CBM 3022 (80 col. Printer with PET graphics—tractor feed)	£605.00
IEEE/RS232 Serial Interface 'A' Output only	£106.00
IEEE/RS232 Serial Interface 'B' Input/output	£186.00
IEEE-488/Centronics type parallel Interface	£45.00
PET C2N External Cassette Deck	£53.00
Interface to S100 (4 slot motherboard)	£112.00
IEEE to Pet Cable	£19.00
IEEE to IEEE Cable	£24.00

### Sorcerer

Now with the  
S100 Bus Expansion  
Interface and Dual  
Drive mini-floppy Disk



Authorized  
Dealers

Sorcerer 16K RAM (inc.UHF Modulator)	£740.00
Sorcerer 32K RAM (including UHF Modulator)	£840.00
Exidy Video Monitor (High Resolution)	£240.00
Exidy Dual Drive mini-floppy Disk (630K storage)	£1195.00
Exidy S100 Bus with Interface+Motherboard+PSU	£200.00
Exidy Mini-floppy Disk Drive (143K Storage)	£495.00
CP/M for Sorcerer on Disk	£145.00

### APPLE II/ITT 2020 /EUROAPPLE

Computer with PALSOFT in ROM (16K RAM) B/W	£799.00
Computer with PALSOFT in ROM (16K RAM) Colour	£895.00
Apple mini-floppy Disk Drive (116K storage)	£425.00
Parallel Printer Interface Card	£110.00
High Speed Serial (RS232C) Card	£110.00
RAM Upgrade (16-32K, 32 48K) (Kit £80)	£ 85.00
ITT 2020 & EUROAPPLE Authorised Dealers	

### Advanced Systems

Altair, Equinox, Billings, Heath, Rair, Horizon.  
Installations to include hard disk, and multi tasking

### Terminals

(Most Brands)  
Pentland V1, 80 char./24 lines 2 page memory

**Ansaback** 'Phonemate' Telephone Answering Machine, voice operated twin cassette

### Software

<b>Petsoft COMPUSSETTES</b> Personal Software	GEMSOFT
<b>Lifeboat Associates</b> (Authorised Dealerships, Send for Catalogues)	
PILOT (for TRS 80) text orientated language	£18.00
COMAC - Computerised Accounting for TRS 80	£50.00
STOCK CONTROL (TRS 80) Inventory, P/O & Invoicing	£125.00
CP/M for TRS 80	£95.00
CBASIC for TRS 80 & Sorcerer	£75.00
Estate/Employment Agency Systems, Fortran 80, Cobol 80, Pascal	

### Etc.

Diskettes 5¼ (blank) boxed (min. order 10) each	from £3.00
C12 Cassettes (Min. order 10) each	£0.41
CBM KIM 1 Microcomputer System	£94.00
Computalk Speech Synthesis for S100	£350.00
Books - Large range of Microcomputer related books & magazines.	

If you don't see it - ask if we have it.



## TRS 80 MODEL II is coming... with up to 64 K RAM and 2-0 MB Disk Storage!

TRS 80, 4K Level 1 (Keyboard with 4K memory+ VDU+Cassette drive+240v PSU)	£365.00
TRS 80, 4K Level II (as above but with Level II basic)	£425.00
TRS 80, 16K Level II (as above but with 16K memory)	£499.00
TRS 80, 4K Level I - Keyboard+240v PSU only	£350.00
TRS 80, Expansion Interface with 16K RAM	£275.00
TRS 80, Expansion Interface with 32K RAM	£360.00
Shugart Mini-floppy Disk Drive (including PSU)	£315.00
Micropolis Mini-floppy Disk Drive (including PSU)	£350.00
Percom FD200 Mini-floppy Disk Drive (inc. PSU) 110v.	£299.00
Micropolis Dual Drive (394K) (including PSU)	£1195.00
TVJ 232T Serial Interface for TRS 80	£45.00
TRS 80 Screen Printer (text+graphics) (110V)	£445.00
Centronics Parallel Printer Interface for TRS 80	£45.00
TRS 80 Voice Synthesizer	£345.00
TRS 80 Numeric Key Pad supplied & fitted	£69.00
New Radio Shack Micro Printer	£245.00
Radio Shack Phone Modem	£160.00
NEWDOS Super-enhanced TRSDOS	£49.00
Level III Super-enhanced BASIC	£34.00
RSM Assemble/Monitor on Disk	£19.95
MICROCHESS or SARGON CHESS Cassette/Disk	£14.00
UHF Modulators (encased with leads for 625 lines)	£20.00
RAM upgrade (4-16K, 16-32K, 32-48K) supplied and fitted at our premises (Kit £80)	£ 85.00
Switchable selection of Level I or Level II (ROMS required)	£25.00
Automatic volume control (AVC) for CLOAD	£25.00
'Electric Pencil' text/word processing package (on cassette)	£65.00
'Electric Pencil' text/word processing package (disk version)	£109.00
'Electric Pencil' keyboard mod. to give lower case with text/word processing package.	£28.00
S100 Interface for TRS 80 (6 slots)	£375.00
'Library 100' - 100 progs for TRS 80 on cassette (Level II)	£39.00

NOW AVAILABLE

## CompuColor II



Computer with colour Monitor, Keyboard and Integral Disk Drive	
From only	£1058.00
Second Disk Drive	£316.00
Programmed Diskette albums available from	£ 9.00

### Printers

Teletype 43 KSR Serial Printer	£825.00
Teletype 33 KSR Serial (110 Baud) Reconditioned	£550.00
Centronics 779 parallel (friction feed)	£750.00
Centronics 779 parallel printer (tractor feed)	£825.00
Anadex DP 8000 serial/parallel printer (112c.p.s.bi-directional tractor feed)	£575.00
Centronics Micro printer (20, 40, 80 columns selectable)	£395.00
PRINTERM 879 Pin feed (100c.p.s. bi-directional)	£695.00
HEATH WH 14	£510.00
TRENDCOM 100 (40 c.p.s. bi-directional, thermal)	£243.00
QUME or DIABLO daisy wheel serial printers	P.O.A.

PRICES EXCLUDE VAT, FREIGHT & HANDLING SEND OR PHONE FOR PRICE LIST & BROCHURES (All prices correct at time of compilation)

Directors: Dr. R.V. King, BA, MIEE.  
S.G. Johnson, BSc. (Hons.)  
T.S. Johnson, ABIBA, ACMB, FBSC, MBIM  
A.S. Barton, ACII, ABIBA, CdiPAF.



T & V JOHNSON (MICROCOMPUTERS ETC) LTD.

Member of the TV Johnson Group of Companies  
165 London Road, Camberley, Surrey GU15 3JS  
48 Gloucester Road, Bristol BS7 8BH  
148 Cowley Road, Oxford OX4 1JJ.

Branches at: Birmingham, Bristol, Edinburgh, Leeds, London, Louth, Newmarket, Nottingham, Oxford, Byfleet, Wokingham.



CAMBERLEY (0276) 62506  
BRISTOL (0272) 422061  
OXFORD (0865) 721461

+ Ansaback eves and w/ends.

Telex 858893

Hours of business 9.30-5.30 Mon-Fri. 9.30-1.00 Sat.

# Everything you always wanted to plug into your PET, APPLE or TRS-80\*

TRS-80  
HARDWARE

TRS-80  
SOFTWARE

## DOUBLE DENSITY DISK STORAGE FOR THE TRS-80

(220% capacity of Radio Shack's)

TRS-80 owners can now increase their on-line mass storage capacity to 200K bytes. How? By using the 77 track Micropolis model 1033-II dual drives.

Cost: only £1195 for two drives, to give 394K on-line.

How does it work? By writing on 77 tracks (instead of the conventional 35) with precision head positioning.

How do I use it? TVJ Microcomputers Etc. provides you with a special program to let your TRS-80 DOS know there are extra tracks. This program was written especially by Randy Cook, author of TRS-80 DOS.

Will the double density disk work with my Radio Shack drives? Yes, except of course for copying an entire 77 track disk to a 35 track drive.

### NEW

Radio Shack Voice Synthesizer for TRS 80 provides the ability to speak in English and limited foreign languages. Capable of producing 62 phonemes (sound units) that are the building blocks of spoken language. Includes audio amplifier and speaker. . . . . £345.

TRS 80 Printer Interface Cable — allows you to connect a parallel printer (e.g. Centronics 700 series) directly to your Level II Keyboard, i.e. Expansion Interface not required. . . . . £54.

TRS 80 Numeric Keypad Mod. — Calculator Style Numeric Key pad which sits to the right of the standard keypad; has keys for 0 to 9, decimal point and ENTER. Both Keyboards active at the same time. . . . . £69.

Radio Shack Microprinter for TRS 80, 40 column 2½" electro-static Printer, switch selectable RS232 Centronics Parallel and TRS 80 BUS Interfaces. . . . . £245.

TRENDCOM Printers for TRS 80, PET or APPLE. 40 cps, 40 column Thermal Printer. . . . . £243.

TRS 80 Interface for Trendcom Printer. . . . . £29.

PET/APPLE Interface for Trendcom Printer. . . . . £49.

### APPLE

SPEECHLAB — provides voice control for the Apple. Train your Apple to understand and act upon the spoken word (inc. microphone). . . . . £165.00

REAL TIME CLOCK — 1/1000 sec. to 388 days with interrupt;

Software controllable, Rechargeable Battery back-up when A/C power off. . . . . £165.00

GRAPHICS LIGHT PEN. . . . . £165.00

PASCAL CARD — Powerful new language for the Business User. . . . . P.O.A.

COMMUNICATIONS CARD, allows APPLE to exchange data with a remote computer over ordinary telephone lines through a modem. . . . . £140.00

AC line controller — allows APPLE to monitor and control AC devices remotely. . . . . £270.00

T & V JOHNSON (MICROCOMPUTERS ETC) LTD.  
Member of the TV Johnson Group of Companies  
165 London Road, Camberley, Surrey GU15 3JS  
48 Gloucester Road, Bristol BS7 8BH

DATA MANAGEMENT/REPORT GENERATOR — easily formats disk files, allows entry, edit, delete & list of records; and retrieves data for display or calculation on screen or printer. . . . . £200.

ELECTRIC PENCIL — powerful word processor allows full cursor movement, insert/delete, string search, block movement, adjustable line length, justification (on cassette). £65.

LOWER CASE MOD KIT FOR ABOVE. . . . . £28

DISK BASED WORD PROCESSING PACKAGE. . . £124.95

RSM-2D DISK MONITOR — powerful system manipulates disk data, has Z-80 breakpoint routine. . . . . £25

ESP-1 EDITOR/ASSEMBLER. . . . . £29.95

RSM-IS MACH, LANGUAGE MONITOR tape base. £23.95

DCV DISK CONVERSION UTILITY — use with TAPE-DISK utility to save system tapes on disk (i.e.) Pencil. £9.95

UTILITY PACK 1 — a) Libloader merges from tapes  
b) Renummer (spec. mem. size); Statement analysis for debussing. . . . . £9.95 ea. all 3 for £24.95

SARGON CHESS — 16K lv II — the 1978 champ. . . . £14

MICROCHESS 1.5 by Jennings — 4K any lev. . . . . £14

LIBRARY 100 — an assortment of 100 programs for. . £39

MAZE — random maze on the TRS-80 graphics. . . . £14

Ask about our COMPLETE BUSINESS SYSTEM

FORTTRAN IV FOR THE TRS-80! Finally, for high speed calculations on your micro, MICROSOFT's FORTRAN can speed up those computation-bound programs. Complete package includes compiler, .relocatable assembler, text editor, and linking loader. . . . . £244.

CP/M + CBASIC for TRS-80. . . . . £170.

NEW DOS — TRSDOS with corrections & enhancements £25

NEW DOS + — As above but with further facilities: KBFIX, RENUM, Screen to Printer one step, DOS commands from BASIC, Level I in II, SUPERZAP, Disassembler, Open 'E' variables. . . . . £49.

### PET

JOYSTICK PACKAGE — complete with connector, software, instructiond. . . . £39.95 single, . . . . £59.95 dual.

MICROCHESS 2.0 by Jennings. . . . . £14

ASTROLOGY/NATAL PACKAGE — sophisticated chart computation with PET graphics. . . . . £14.95

SUBS — best graphics yet — drop depth charges on the subs below you and rack up points. Complete adjustability for many same variations. . . . . £19.95

SUPER MAZE — 2 games in 1: Tunnel vision lets you travel through the maze in perspective with graphics, also Kat'n' mouse chase. . . . . £19.95

74 COMMON BASIC PROGRAMS on 1 tape. . . . . £15

19 different games at. . . . . £9.95

PETACT BUSINESS SYSTEMS. . . . . P.O.A.



Branches at: Birmingham, Bristol, Edinburgh, Leeds, London, Louth, Newmarket, Nottingham, Oxford, Byfleet, Wokingham.

• Circle No. 271

# METROTECH

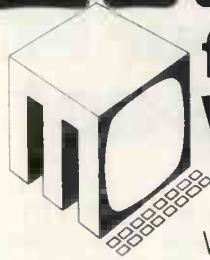

## for The Working Micro

We take the confusion out of micros and make them work for you in your business.

We provide a flexible approach by utilising wide ranging, standard and compatible equipment from more than one manufacturer and make them into multi-purpose work-horses for your business.

A number of options are available for the micros including an excellent word processing system, a robust accounting system and an easy to use database for information storage and retrieval. For details of these and other options, phone Peter Cheesewright on 0895 57780.

**Make an appointment to visit our permanent Exhibition and talk to our staff**



**METROTECH**

Waterloo Road Uxbridge Middlesex

METROTECH is a member of the GRAND METROPOLITAN group of companies

• Circle No. 272

## TO COMMEMORATE THE AGE OF NEW TECHNOLOGY

The Silicon Chip has not only revolutionised the computers of to-day but all aspects of industry. Micro-electronics will be found increasingly more in our everyday lives, and will no doubt have a profound effect on society as we know it.

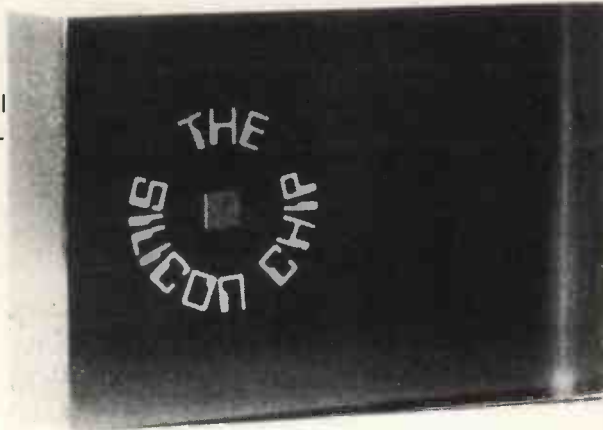

To commemorate the 'Second Industrial Revolution'

S.A.S. have embedded an actual Silicon Chip in an acrylic monument which will provide a permanent display for either your home, office or school. The Christmas season is less than two months away, so order now, as this will be an ideal gift for your customers, colleagues, friends or even yourself.

## THIS AMAZING OFFER AT A PRICE OF ONLY

**£6.75** *Includes VAT Postage, and Packing*

For companies wishing to use this for their own promotional aid, S.A.S. will present the company name and/or logo within the acrylic monument for a small additional cost. Write to the Freepost Address for further details of this personalised service. Please allow 30 days for delivery

Post this coupon to:  
S.A.S. Ltd (Dept. PB/1)  
Freepost, Greenford, Middx UB6 8BR.

Name .....

Address .....

Please send me  Monuments.  
I enclose Cheque/P.O.'s for £.....  
or charge my Access Card Number

.....  
Signed .....

• Circle No. 273

# Listen, Westrex have more to offer than you realise.

Yes more new models. A bigger sales and service team. And plenty of new ideas. Give us a ring now and let's talk.

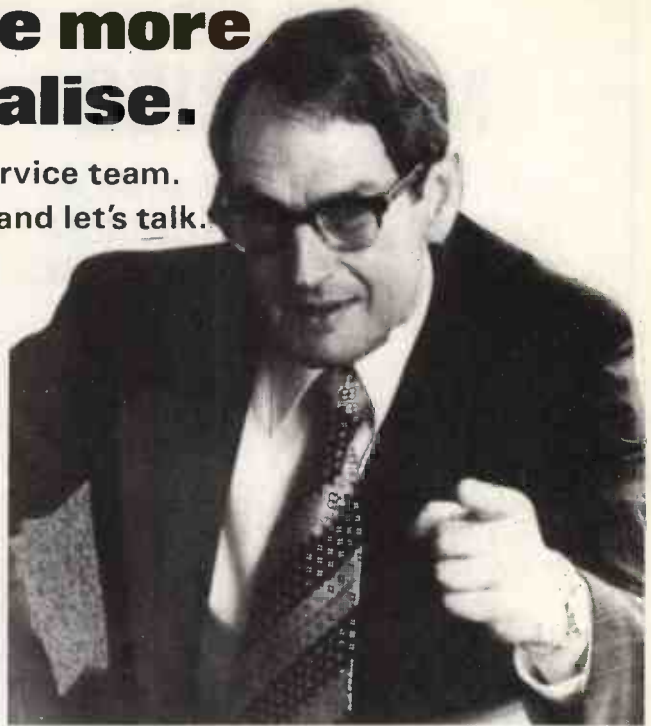

Fred Allen Managing Director Westrex Company



TALLY 1600 series micro controlled KSR 160 C.P.S. matrix printers.



TELETYPE MODEL 43 10/30 C.P.S. Keyboard send/receive terminal.

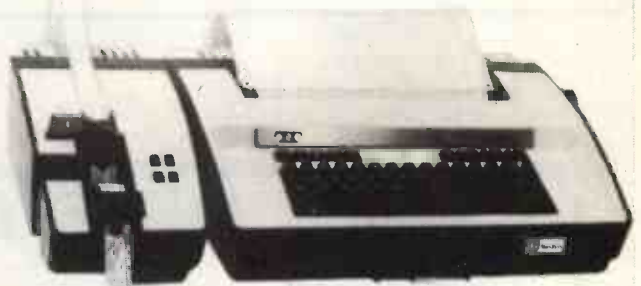

TELETYPE MODEL 43 Automatic send/receive terminal with paper tape reader and punch.

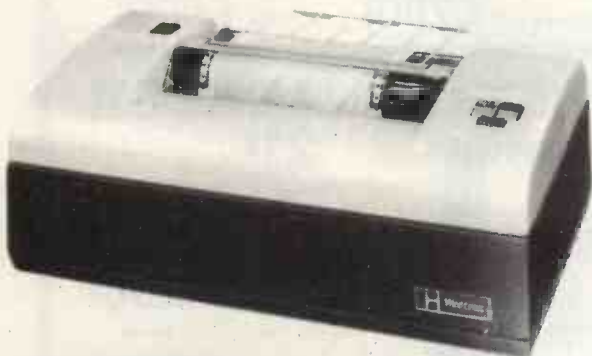

MANNESMANN MODEL 80 series receive only matrix printers.



PERKIN ELMER 550 BANTAM. Teletype compatible Visual Display unit.



**SEE US AT COMPEC '79**

Westrex Company Limited, 152 Coles Green Road, London NW2 7HE. Tel: 01-452 5401 and at Manchester Telephone: 061-764 0324 and Glasgow Telephone: 041-332 2052/3

• Circle No. 274

# WE HAVE MEMORIES

AM2708	1K x 8	EPROM
TMS2516	2K x 8	EPROM
TMS2716	2K x 8	EPROM
2102L	1K x 1	SRAM
2114-2	1K x 4	SRAM
4060	4K x 1	DRAM
4096-16	4K x 1	DRAM
4116-3	16K x 1	DRAM
Z-80 CPU	4MHz	
Z-80 PIO	4MHz	



Send S.A.E. for full list and prices

## STRUTT

Electrical and Mechanical  
Engineering Ltd.  
Electronic Component  
Distributors

3c Barley Market Street,  
Tavistock,  
Devon PL19 05F  
Tel: Tavistock (0822) 5439  
Telex: 45263

• Circle No. 275



## DDT MAINTENANCE LTD

12 Leeming Rd  
Borehamwood  
Herts. WD6 4DU  
01-207 1717

58-60 Northfield Rd  
Kings Norton  
Birmingham B30 1JH  
021 459 5959

5-6 Lower Church St  
Chepstow  
Gwent NP6 5HJ  
029 12 2193

Glasgow 041 221 9761

Telex 49280

Manchester Office Opens Shortly

Micro Systems Maintenance: —

On Site / Time : Parts / Workshop Repair / BD  
Exchanges

All the above are available for most leading Micro  
Systems and their associated peripherals. For further  
details ring The Micro Maintenance Experts.

## \* SPECIAL OFFER \*

9in. Unused American 110V Video Monitors in Cases  
£15.00 + VAT. Place your order now.

### DDT MAINTENANCE LTD

• Circle No. 276



## 32K PET

The professional version ...  
some power!!  
Full size keyboard,  
easy-on-the-eye green display.  
Now at reduced price ...

only **£725!**

16K **£625!**

## EXIDY SORCERER



User-definable graphics. Plug-in interpreter ROMs. (Basic supplied).  
Sophisticated Z80 system! Plug into own TV or monitor and cassette.

32K now only **£790!**

16K **£690!**

## APPLE II

Best 6502 system! Up to  
48K RAM on-board ....  
Plug into own colour or  
B/W TV & cassette.

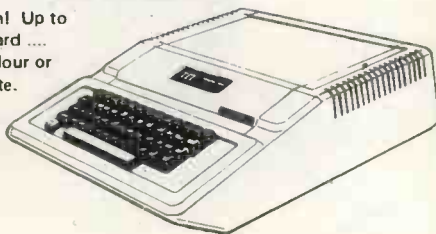

48K only  
**£970!**

16K  
**£870!**

Memory expansions, discs and printers  
for all above from stock.



Computerama,  
Department P.C.I.

Harpers Kensington Showrooms, Send for free list.  
London Road, Bath, Avon.  
Telephone (0225) 28819.

## OHIO CHALLENGER 2P



Sophisticated 6502 system!! Plug into  
own TV or monitor! 20K RAM.  
Interpreter Basic!  
Ex-stock, with single mini-floppy

only **£1200!**

with dual mini-floppies, save at  
**£1530!**

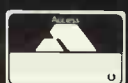
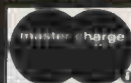

Access and Barclaycard  
orders accepted by phone or  
letter, just quote number  
and print name and address.

• Circle No. 277



# hi-tech electronics

1 Richmond Gardens, Highfield Southampton SO2 1RY  
Telephone (0703) 555072

OUR S 100 **COLOUR** VDU BOARD

WILL MAKE YOUR FRIENDS GREEN WITH ENVY AND OUR COMPETITORS SEE RED  
AND ANY OTHER OF OUR FIFTEEN COLOURS

- HIGH DEFINITION, FULLY INTERLACED 625 LINE PAL COLOUR VDU
- 15 COLOURS, INCLUDING FULLY SATURATED RED, GREEN, BLUE, YELLOW, MAGENTA, CYAN, ETC.
- 24 LINES OF 40 CHARACTERS, MIXED GRAPHIC AND ALPHANUMERIC
- COLOUR GRAPHICS RESOLUTION OF 80x72
- UPPER AND LOWER-CASE COLOUR ALPHANUMERICS, WITH FULL CHARACTER ROUNDING GIVING A DEFINITION OF 10x14
- ALL CHARACTERS CAN FLASH AND HAVE ANY HUE
- SEPARATE BACK AND FORE-GROUND COLOURS, BOTH GRAPHICS AND ALPHANUMERICS CAN BE DISPLAYED ON A COLOURED GROUND
- ADJOINING AND NON-ADJOINING GRAPHICS SYMBOLS
- SELECTABLE DOUBLE HEIGHT CHARACTERS AND TWO PAGE MEMORY
- MEMORY MAPPED TO ANY 1K BOUNDARY
- BRITISH DESIGN FOR COMPATABILITY WITH UK TV SETS
- MONITOR AND UHF OUTPUTS

PRICES INCLUDE P&P BUT NOT 15% VAT

- |  |         |
|--|---------|
| • S100 COLOUR VDU BOARD                  | £215.05 |
| • S100 16K MEMORY, 250Ns, FULLY BURNT-IN | £210.95 |
| • S100 PROTOTYPE WIRE-WRAP BOARDS        | £15.00  |

COMING SOON:

- S100 6 NOTE MUSIC SYNTHESISER
- S100 BBC/ITV TELETXT DECODER
- S100 ULTRA-FAST NUMBER CRUNCHER
- LOTS MORE ON THE WAY

HI-TECH  
ELECTRONICS  
FOR  
S 100

• Circle No. 278

# ELECTROVALUE

FOR A GOOD DEAL BETTER THAN MOST  
ESPECIALLY WHEN IT COMES TO

# nm

Nascom Microcomputers

- ★ At new reduced prices
- ★ Appointed national distributors
- ★ Full ranges of available Nascom items for prompt delivery
- ★ Backed by Electrovalue service

### PRICE LIST AND INFORMATION

Gladly sent on request. Your name will be fed to our computer for you to be sent future information automatically

### FREE FOR THE ASKING ELECTROVALUE CATALOGUE 9

Latest 120 page catalogue — ICs, Semi-conductors, On-to-devices, Components, Hardware, Connectors Tools, etc.

### ELECTROVALUE LTD

Dept. PC 479, 28 St Judes Rd,  
Englefield Green, Egham,  
Surrey TW10 0HB.

Phone Egham (389 from London:  
STD 0784-3) 3603; Telex 264475.  
Northern Branch (Personal shoppers only) 680 Burnage Lane, Burnage, Manchester M19 1NA Phone (061) 432 4945.

• Circle No. 279

# DATRON of SHEFFIELD

for

**Cromemco** the ultimate name in micros



DATRON import direct from Cromemco, California. DATRON can supply Nationwide. DATRON can provide fast maintenance anywhere by C.F.M.

DATRON can give you the best prices.

DATRON have in stock:—  
System 2 46K £1995  
System 3 32K £2995  
System 3 64K £3292

DATRON have Z-2H Hard Disc coming soon. DATRON have Systems 2 and 3 and Hard Disc with Multi-User facility.

DATRON easily accessible — in the centre of the country.

Write or telephone for FREE colour brochure on System 3 or Z-2H.  
We use Cromemco for our own business why not call in for a demonstration.

## DATRON MICRO CENTRE

Latham House, 243 London Road, Sheffield S2 4NF.  
Telephone 0742 - 585490. Telex 547151.

• Circle No. 280

# VERBATIM MAGNETIC MEDIA



## THE BEST THAT MONEY CAN BUY.

VERBATIM — the world's finest and best known range of magnetic data storage products — includes Floppy Discs, Mini-Floppies, Cassettes, Mini-Cassettes, cartridges and cards. All are 100% tested during manufacture, all are *certified* error free. We stock all types, including all varieties of the popular 5 1/4-inch floppy discs.

### If you are a dealer:

Start stocking VERBATIM products — your customers will appreciate a better quality product at better prices. Call BFI Electronics for a comprehensive catalogue, dealer price list, and details of display material and retail packaging.

### If you are a user:

Your system is only as good as its data storage — so don't be content with inferior products. Insist on VERBATIM by name, as indeed do some of the biggest names in the computer business!

**BFI Electronics Limited**  
516 Walton Road,  
West Molesey,  
Surrey KT8 0QF  
Tel: 01-941 4066  
Telex: 261395

• Circle No. 281

## INFORMEX-LONDON

Informex-London Ltd, in association with the  
**Institute of Data Processing Management,**  
present a two-day seminar on:

### Microprocessors

Speakers include experts from:  
**MOTOROLA, TEXAS INSTRUMENTS,  
COMMODORE, FERRANTI, PLESSEY, CAP, ICL**

#### Venue

Cafe Royal, Regent Street, London W1

#### Fees

£78 + VAT  
(including lunch & refreshments)

#### Date

20-21 November 1979  
(hours: 10.30 am - 5 pm & 9.30 am - 5 pm)

#### MICROPROCESSORS

The technological revolution. What are  
Microprocessors and Microcomputer Systems?  
Non-technical introduction - the technology - Components -  
Hardware - Software - etc.

#### APPLICATION

for Business, Industry, Government and  
Education,  
Small Business Systems - Word Processing - Control  
Systems - etc.

*Places are also available on the following courses:*  
(all held in Central London - hotel bookings can be arranged)

<b>Microcomputer Appreciation</b> - 2 days £78 + VAT	(Dates: 2 October, 23 October, 6 November, and 4 December 1979) (including lunch at Cafe Royal)
<b>Microcomputer Fundamentals</b> - 5 days £128 + VAT	(Dates: 26 November 1979, 18 February, 17 March, 12 May, 21 July and 15 September 1980)
<b>Computer Systems Fundamentals</b> - 5 days £128 + VAT	(Dates: 5 November 1979, 10 March, 14 April, 7 July and 1 September 1980)
<b>Systems Analysis &amp; Design</b> - 10 days £258 + VAT	(Dates: 12 November 1979, 4 February, 17 March, 14 April, 7 July and 15 September 1980)
<b>Principles of Accounting</b> - 5 days £128 + VAT	(Dates: 29 October, 26 November 1979, 18 February, 14 April, 7 July and 15 September 1980)
<b>COBOL Programming</b> - 10 days £256 + VAT	(Dates: 12 November 1979, 17 March, 14 July and 8 September 1980)
<b>Assembler Programming</b> - 10 days £256 + VAT	(Dates: 1 October, 3 December 1979, 18 February, 12 May, 21 July and 1 September 1980)

For further details or telephone reservations, please  
phone (or write to):

**Course Registrar, 01-309 7799 or 01-300 0380**  
(24 hour answering)

**Informex-London Ltd.**

Freeport, Sidcup, Kent, DA15 9BR

• Circle No. 282

# SERIES I BUSINESS COMPUTER



- \* **Up to 4 Megabytes of disc storage**
- \* **64 Kilobytes of read/write memory**
- \* **Choice of dot matrix or NEC correspondence quality Spinwriter printers**
- \* **Choice of three different VDUs.**

## Software

In addition to CP/M, FORTRAN, BASIC, COBOL and PASCAL we offer the unique 'Insta' software which enables tailor-made applications packages to be configured in a very short time by the computer itself! 'Insta' applications programs can be altered to suit your changing requirements at any time by operators with no knowledge of computer programming but who know what they want it to do.

**If you have not seen 'Insta' software, ask for a demonstration. We promise you that you will have never seen anything that even comes close to matching it in business applications.**

 **compelec**

14-15 BERNERS STREET, LONDON W1P 3DE

Telephone 01-636 1392 (4 lines)

# VT Monitor & Keyboard Kits



Available now  
ex-stock



## Keyboard

- \*Full 128 character ASCII encoding
- \*+5 volt only
- \*Positive or negative strobe
- \*Circuit, layout and full assembly instructions
- \*Two-key roll over
- \*Price £28.50 0 50p p/p

## Monitor

- \*Resolution - 80 charo/line
- \*Video response - 20 MHz
- \*All inputs TTL compatible
- \*9" diagonal high resolution tube, P4 (white) phosphor
- \*625 or 525 line standard
- \*+11v @ 1A input
- \*Price £85 + £2 p/p

Coming soon - boxed, built and tested VDU full cursor control, 16 x 64 format, keyboard & display included - price £280.

All prices include VAT - discounts available

## Video Terminals

197 Hornbeams, Harlow, Essex  
Tel 0279 30132

• Circle No. 284

## SORCERER'S APPRENTICE

Wide range of software available for the Sorcerer  
**BASIC** - illustrates the use of Basic instructions. £ 6.50  
**RENUMBER** - renumbers your Basic programs. £ 6.50  
**WHITE** - sets graphics to display characters on a white background ..... £ 6.50  
**DRAW** - allows freehand drawings on the screen ..... £ 4.60  
**MATHS** - sets problems of varying difficulty ... £ 4.60  
**STATISTICS** - a comprehensive package. .... £17.75  
**CASSETTES** computer quality with case ..... 50p each  
*All above prices include VAT*

Business programs and software from  
**LIFEBOAT ASSOCIATES**  
 Send SAE for our full list  
**WE PUBLISH PROGRAMS**  
 Good royalties available for quality original software  
 Please send copy for inspection

*Exidy Products - full range supplied*  
*Printers - wide selection available*

## MICROPUTE

7 Westbourne Grove Manchester 20  
 Tel. 0625 612818

• Circle No. 285

**RE-FURBISHED  
 IBM SELECTRIC  
 TYPEWRITER TERMINALS**  
 From £695 + VAT.

**VLASAK  
 SOFTWARE  
 SYSTEMS  
 FOR APPLE II**

Built in RS232 interface allows it to be connected to an Apple II, Pet, TRS-80.

In addition to its function as an on-line terminal, the unit can also serve as a standard Selectric office typewriter.

- Labour and parts 30 days.
- 30 days approval for postal orders.
- Maintenance agreement available.

For further information contact:

Vlasak Electronics Ltd., Thames Building,  
 Dedmere Road, Marlow, Bucks.  
 Tel: Marlow 74789. Telex: 847008.



As major Apple distributors we can supply a variety of proven software packages for both the enthusiast and businessman. Our range of fully documented packages include:

Sales Ledger	£315	Stock Programs	£285
Purchase Ledger	£315	Word-Processing/ Letter Writer	£240
Nominal Ledger/ General Ledger	£225	Estate Agent	
Payroll	£360	Program	£240

All prices include an in-house users' instruction course.

• Circle No. 286

# ENSIGN

13-19 MILFORD STREET, SWINDON  
WILTSHIRE SN1 1DW  
Tel: (0793) 42615 Telex: 449703

Make more time available to  
enhance the quality of your  
life and improve your business

COMPUTER SALES • HARDWARE • SOFTWARE • CONSULTANCY • MEDIA • STATIONERY ETC

For less than 25p an hour for just one year you can  
COMPUTERISE YOUR BUSINESS NOW!

EVERYTHING YOU REQUIRE TO START  
COMPLETE - READY TO OPERATE.

Incl. VAT, Pkg. & Delivery. Nothing extra to pay:

## £2,300

- MICROCOMPUTER WITH 48K RAM (Memory)
- DUAL DISK DRIVES (Storage up to 400K)
- DOS DISKETTE (Disk Operating System)
- BOX OF 10 BLANK DISKETTES
- PRINTER WITH TRACTOR FEED
- BOX OF CONTINUOUS STATIONERY/LABELS
- EVERYTHING COMPLETE WITH MANUALS

**+** FREE Programs worth over £500 **+**  
on Diskettes in a Library Case

comprising:

SALES/PURCHASE LEDGERS QUOTE/ORDER/INVOICE  
BANK RECONCILIATION STOCKS / SHARES ANALYSIS  
STOCK CONTROL MAILING LIST GAMES PACKAGE

This package illustrates how to solve many of your business problems.  
They may or may not be suitable for your type of application but they will  
help you develop your own software for virtually any type of business.  
Worth over £500 this package is enclosed FREE.

### SOFTWARE

We are pleased to announce that we have been appointed  
Exclusive Distributor for UK, Europe & the World for  
**GRAMA WINTER SOFTWARE**  
for TRS 80, Apple, ITT 2020. Also dealer for Pet, Z80, SWTP.

Fully integrated suite of 30 complete business programs.  
Usual cost of such Quality Programs would be £2500+.  
Complete support, updates, NHI/Tax changes etc.

Write for details.

Special introductory price ... £575 ... inclusive of VAT.

### CONSULTANCY

Please write or telephone if you require advice on  
BEGINNING or EXPANDING your computer installation.  
Software programs customised to your requirements.

### OUR BUSINESS EXISTS ON IMPROVING YOUR BUSINESS.

Please send Full Details & Price Lists My requirements are for:

HOME  HOBBIES  STUDENT  BUSINESS

Name : .....

Street : .....

Town : .....

County : .....

Post Code : .....

Telephone : .....

Name of Co : .....

Position : .....

PO/Chq No : .....

(Payment by Barclaycard / Trustcard / Access etc., can be arranged)

We are continually adding new products to our range and would be  
pleased to receive your enquiries. ● Quantity Discounts available.

TRS 80		ex. VAT	inc. VAT
4K Level 2	(c/w K/bd, VDU, T/Rec)	434.78	500.
16K Level 2	(c/w K/bd, VDU, T/Rec)	500.00	575.
0K Interface	(to add printer & disk drives)	195.66	225.
16K Upgrade kits	(for k/bd or interface)	65.22	75.
Disk Drives, single	(up to 200K)	260.88	300.
Disk Drives, dual	(up to 400K)	608.70	700.
Disk Drives, dual	(up to 1000K)	1173.91	1350.
Disk Drives, dual	(up to 2000K)	1521.74	1750.
Disk Drives, cable 2 & 4 way from		21.74	25.
Anadex Printer, Tractor feed		434.78	500.
Printer cable for Anadex/Centronics		21.74	25.

### APPLE II ITT 2020

16K	(c/w Keybd & Palsoft ROM)	608.70	700.
16K Upgrade kits		65.22	75.
Disk Drive, single with cable		326.09	375.
Printer Interface		108.70	125.
Anadex Printer, tractor feed		434.78	500.
Colour TV ITT 340		239.13	275.

### COMMODORE PET

2001-32N	(New keyboard & 32K)	673.91	775.
2040 Dual Disk Drive 343K		673.91	775.
3022 Printer with graphics		521.74	600.
Printer interface and cables, each		21.74	25.

### MEDIA LIST

5¼" Verbatim	from (Qty 10)	17.39	20.
5¼" Dysan	from (Qty 10)	26.09	30.
8½" 3M	from (Qty 10)	30.44	35.

Blank 5¼" & 8½" Diskettes, Soft/Hard Sector, Formatted/ Unformatted.  
We have Diskettes to suit many systems. When ordering please quote:  
SYSTEM MANUFACTURER, MODEL, MEDIA TYPE, AND DISK SIZE.  
Available in smaller or larger quantities.

### STATIONERY Listing Paper, Continuous Forms, Labels.

Listing paper 11" x 8½", white/green music ruled, boxed 2000 ..... £10  
Labels 2¼" x 1½", white, fanfold, £5 per 1000 ... 10,000 for ..... £40

Post/Packing/Insurance extra. Delivery by Registered Post, Securicor, etc.

Price List correct at time of going to Press, subject to change without notice. E. & O.E.  
Standard Warranties apply.

### Your enquiries assist us in forward purchasing.

Requirements	Description	inc. VAT
Microcomputer	.....	
Upgrade Kit	.....	
Interface	.....	
Disk Drive	.....	
Printer	.....	
Cable/Interface	.....	
Cluster System	.....	
Colour TV	.....	
Media	.....	
Stationery	.....	
Software	.....	
Post/Pkg/Ins	(please tel. for cost) .....	
PC/PCW/L		
TOTAL:		.....

● Circle No. 287

## \*\*\* 8-BITS OR 16-BITS \*\*\*

Do you want a microcomputer kit based on a 16-bit microprocessor? Or an 8-bit microprocessor with a microassembler? Supply your own ASCII-encoded keyboard? No need to look further as BL Microelectronics has developed the BIPROC microcomputer kit with a choice of two microprocessors on a common PTH board.

### MICROPROCESSORS

- 16-bits TMS9980-69 instructions including multiply and divide — 7 addressing modes including indirect and memory to memory — 16 general-purpose registers file positioned anywhere in memory.
- 8-bits Z-80 firmly established in the hobby and academic fields.

### BOARD FEATURES

- Monitor and microassembler resident in EPROM.
- 1K User RAM, upto 4K EPROM.
- TV, cassette and RS232C memory-mapped interface.
- 16 lines of 64 characters each on TV screen.
- Programmable character generator.
- Interface for ASCII-encoded keyboard.
- Expandable • Manual — some useful programs listed.

### PRICE

- |   |                |            |
|---|----------------|------------|
| • BIPROC Kit 1                              | Z-80 only      | £164 + VAT |
| • BIPROC Kit 2                              | TMS 9980 only  | £169 + VAT |
| • BIPROC Kit 3                              | Z-80 & TMS9980 | £195 + VAT |
| Keyboard not included in above kits         |                |            |
| • 57 pos. keyboard suitable for above kits. |                | £30 + VAT  |
| • Expansion board for up to 4K RAM (2114S)  |                | £8 + VAT   |

*Details and demonstration at:*  
Watford Electronics,  
33/35 Cardiff Rd.,  
Watford,  
Herts.  
WD1 8ED  
Tel: Watford 40588/9

*Trade only:*  
B. L. Microelectronics  
1 Willow Way,  
Loudwater,  
Bucks.  
HP11 1JR

• Circle No. 288

## Microcomputer Mail Order



GREAT BRITAIN

All your microcomputer requirements can be bought with confidence by mail order from MICRODIGITAL, one of the largest and longest established computer stores.

Most orders are despatched same day as receipt, if not a note explaining what the supply situation is. If we cannot supply within 30 days we will, on request, make an immediate cash refund.

Access and Barclaycard orders are welcome either in writing or over the phone. Your account will not be charged until the goods are despatched.

Official orders of over £10 are also welcome. With normal 30 days trade credit extended to bona fide commercial and government organisations.

If you do not have our brochures, write or phone today for free copies by return.



# MICRODIGITAL

MICRODIGITAL LIMITED  
FREEPOST (No stamp required) LIVERPOOL L2 2AB  
TEL: 051-236 0707 (MAIL ORDER 24 HOURS A DAY)  
TEL: 051-227 2535



• Circle No. 289

# PETAID

**PET USERS and budding PET PROGRAMMERS —**  
**Feel Like Giving Up? Our Advice is — Don't!**  
**Get PETAID and write good commercial software in**  
**HOURS NOT WEEKS.**

**PETAID Version 1** is a file based utility program designed to help people develop their own file based programs in a fraction of the time it takes to write them in Basic.  
Weeks of Programming become Hours  
All your programs will perform to the same high standard  
All your programs will operate as professionally written commercial software

### With PETAID CREATE Your Own:

Suppliers Files  
Customer Files  
Mailing Lists  
Personnel Files  
Address Book  
Amenities File  
Diary File  
Price Lists  
Parts List  
Stock File  
Sales Lead Lists  
Patient Registers  
Etc. Etc.

### Incorporated in the PETAID Package is:

— a powerful search function which allows the user to search his database on his own defined basis.  
— a powerful set of commands — AND, OR, NOT, GREATER THAN, LESS THAN, EQUAL TO.  
— embodied is a string search function which enables the user to locate records based on a string contained somewhere within the record.  
The above features and commands may be used in conjunction with one another with no limit on the number of defined operands apart from practicality.

### NOW AVAILABLE!

— Tape based version £80 — Commodore Disk based version £120 (Seq. files) —  
— Documentation £10 —

### FUTURE Versions of PETAID:

1. Random Access
2. Print generators
3. Search & Extract an index/new file/print
4. Sort Utilities
5. Transaction Handling
6. Word Processor package
7. Other commercial packages.

# STAGE ONE COMPUTERS

6 Criterion Arcade  
Old Christchurch Road  
Bournemouth  
Tel. 23570

• Circle No. 290

EUROPE'S LARGEST SELECTION OF MICROCOMPUTER BOOKS, MAGAZINES AND SOFTWARE FOR THE HOBBYIST, EDUCATIONALIST  
PROFESSIONAL AND RETAILER.

## BOOKS

**SUMMER HOLIDAY BONUS.** For the purchase of 3 books or more,  
and paying by cheque, P.O. or cash, give yourself a 10% DISCOUNT!

Introduction to Microcomputers: by Osborne	
Vol 0: Beginners Book	£5.95
Vol 1: Basic Concepts	£6.30
Vol 2: Some Real Microprocessors (without binder)	£18.95
Vol 2: Some Real Microprocessors (with binder)	£24.70
Vol 3: Some Real Support Devices (without binder)	£11.95
Vol 3: Some Real Support Devices (with binder)	£17.70
Updating subscription (6 issues) for Vol 2	£18.95
Updating subscription (6 issues) for Vol 3	£18.95
Updating subscriptions for Vol 2 & 3	£30.00
1 Updating issue (specify for Vol 2 or 3)	£4.00
1 Binder (specify for Vol 2 or 3)	£5.75

Microprocessors from Chips to Systems	£7.00
Microprocessor Interfacing Techniques	£8.75
Z80 Microcomputer Handbook	£7.50
TV Typewriter Cookbook	£7.50
Cheap Video Cookbook	£4.30
CMOS Cookbook	£7.50
IC OF AMP Cookbook	£8.95
RTL Cookbook	£4.25
TTL Cookbook	£7.50
IC Timer Cookbook	£7.50
Ciacrcis Circuit Cellar	£5.50
First Book of KIM	£7.00

6800 Programming for Logic Design	£6.30
8080 Programming for Logic Design	£6.30
Z80 Programming for Logic Design	£6.30

Introduction to Personal and Business Computing	£4.95
Getting Involved with your Own Computer	£4.75
Buyer's Guide to Microsoftware	£2.40
How to Profit from Your Personal Computer	£5.50
Microcomputer Potpourri	£1.75
Hobby Computers are Here	£3.95
New Hobby Computers	£3.95
Understanding Microcomputers and Small Computer Systems	£6.95

More BASIC Computer Games (coming soon)	£5.50
BASIC Computer Games (also see software section)	£5.00
What To Do After You Hit Return	£8.95
8080 Galaxy Game	£6.95
SUPER-WUMPUS A game in 6800 Assembler code & BASIC	£4.25
Computer Music	£6.75
Computer Rage (A Board Game)	£6.95
Artist and Computer	£3.95
Games with a Pocket Calculator	£1.75
Games, Tricks & Puzzles for a Hand Calculator	£2.49
Introduction to TRS-80 graphics	£5.75
Take My Computer Please... (light hearted fiction)	£3.25

Instant BASIC	£6.95
Basic BASIC	£6.50
Advanced BASIC	£6.00
My Computer Likes Me... When I Speak in BASIC	£2.75
Calculating with BASIC	£4.95
Users Guide to North Star BASIC	£10.00
Introduction to PASCAL	£3.95

Z80 Instruction Handbook	£2.95
8080 Programmers Pocket Guide	£1.95
8080 Hex Code Card	£1.95
8080 Octal Code Card	£1.95

Accounts Payable and Accounts Receivable	£10.95
Payroll with Cost Accounting	£10.95
General Ledger	£10.95

Best of BYTE	£8.95
Scelbi BYTE Primer	£8.95
Best of Creative Computing Vol 1	£6.95
Best of Creative Computing Vol 2	£6.95
Best of MICRO (Issues 1-6 of Micro Magazine)	£5.50

Basic Software Library:	
Vol 1: Business and Games Programs	£17.50
Vol 2: Maths, Engineering and Statistical Programs	£17.50
Vol 3: Advanced Business Programs	£26.95
Vol 4: General Purpose Programs	£7.95
Vol 5: Experimenters Programs	£7.95
Vol 6: Miniature Business System	£32.50
Vol 7: Chess/ Medbil/ Wdproc Programs	£26.95

Z80 Assembly Language Programming (coming soon)	£6.45
6502 Assembly Language Programming (coming soon)	£6.45
Microcomputer Programming 6502	£7.95
6502 Applications Book (coming soon)	£7.95
8080A/8085 Assembly Language Programming	£6.45
6800 Assembly Language Programming	£6.45
8080 Software Gourmet Guide and Cookbook	£6.95
6800 Software Gourmet Guide and Cookbook	£6.95
8080/8085 Software Design	£6.75
6800 Tracer - An aid to 6800 Programme Debugging	£3.95
Program Design	£4.25
Programming Techniques: Simulation	£4.25

Some Common BASIC Programs	£6.30
Computer Programs that Work (in BASIC)	£2.55
32 BASIC Programs for the PET	£10.10

PIMS - A Database Management System	£5.95
Scelbi High Level Language + Supplements	£15.00
Basex - A Simple Language + Compiler for the 8080	£5.50

8080 Standard Monitor	£9.95
8080 Standard Editor	£9.95
8080 Standard Assembler	£9.95
Special Package: 8080 Assembler, Editor, Monitor	£20.00
Bar Code Loader for 6800, 8080, Z80 and 6502	£1.75
Tiny Assembler for 6800 Systems	£5.75
RA 6800 ML - An M600 Relocatable Macro Assembler	£15.95
LINK 68 - An M6800 Linking Loader	£5.50
MONDEB - An advanced M6800 Monitor Debugger	£3.50

## MAGAZINES

**SUMMER HOLIDAY BONUS:** For the purchase of 3 Magazines or more,  
and paying by cheque, P.O. or cash, give yourself a 10% DISCOUNT!

Magazine Subscriptions:	UK Price	Overseas Price
Subscriptions start within 3 weeks		
MICRO 6502 Journal (12 issues)	£12.50	£12.50
Personal Computing (12 issues)	£17.00	£17.00
Interface Age (12 issues)	£25.00	£25.00
Dr Dobbs Journal (10 issues)	£13.50	£13.50
Computer Music Journal (4 issues)	£11.00	£11.00
People's Computers (6 issues)	£8.50	£8.50
BYTE (12 issues)	£24.50	£24.50
Creative Computing (12 issues)	£16.50	£16.50
Kilobaud (12 issues)	£21.00	£21.00

Magazine Back Issues:	
Micro-6502 Journal	£1.50
Personal Computing	£1.95
Interface Age	£2.95
ROM	£1.95
Dr Dobbs Journal	£1.95
Computer Music Journal	£3.75
People's Computers	£1.95
BYTE	£2.95
Creative Computing	£1.95
Calculators and Computers	£1.95
Kilobaud (reprints only)	P.O.A.
73	£2.25
Magazine Storage Box (Holds 12)	£1.25

### HOW TO ORDER

Please note our book magazine prices include postage and packing, but not insurance, if wanted add 12p for every £10 of books ordered. Make cheques, PO's etc. payable to: -

**L.P. Enterprises.**

CREDIT CARDS accepted  
BARCLAYCARD VISA/ACCESS/DINERS CLUB/  
AMERICAN EXPRESS

Phone: 01-553 1001 for Credit Card orders (24 hr answering service)

All publications are published in U.S.A. and shipped into Britain air-freight by L.P. Enterprises. In unusual cases, processing may exceed 30 days.

Prices subject to change without notice

**TRADE ENQUIRIES WELCOME**

**THIS LIST CANCELS ALL PREVIOUS PRICE LISTS: EFFECTIVE JULY 1979  
DUE TO FLUCTUATIONS OF THE DOLLAR. PRICES SUBJECT TO CHANGE WITHOUT NOTICE.**

Send to address on page	All Orders must be Prepaid:
Indicate Payment Method; and underline items required.	Total Enclosed £ .....
..... My cheque, P.O., I.M.O. is enclosed in Sterling on U.K. Bank	..... Charge to Barclaycard/Visa/Access/Diners/American Express
Credit Card No. ....	Expiry Date .....
Name .....	
Address .....	
.....	POSTCODE .....
Signature .....	

# CPS

## DATA SYSTEMS

# The Midlands Micro Sales Centre

Established by CPS to ensure that you buy the micro best suited to your particular need. During your visit you can see, and try at leisure a whole range of microcomputers. Expert advice is always on hand to guide you through our hardware, software and back-up services.

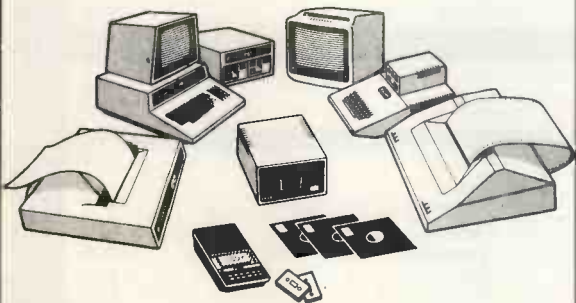

We're Authorised Dealers for **Pet, Apple, Rair** and **Transdata** microcomputers; **Decision Data** and **Datac** printers; and **Lear Siegler** terminals — all available off-the-shelf;

phone us today, to arrange your visit, or for product information

**Telephone: 021-707 3866**



**CPS**  
DATA SYSTEMS

Third Floor, Arden House, 1102 Warwick Road,  
Acocks Green, Birmingham B27 6BH

A member of the CPS Group

• Circle No. 292

## V&T ELECTRONICS

### V&T SUPERDECK

The cost-effective answer to mass data storage and retrieval; stores two megabytes per C60 cassette; data transfer rate 5,000 baud; full search facilities in fast-forward and fast-reverse modes under our operating system (Z-80 software only) allows you to:

Retrieve a named file (searches at up to 50 inches per second).

Write a file

Write a write-protected file

Replace a file

Delete a file

Error rate less than 1 per  $10^8$  bits, in the unlikely event of an error the operating system will re-read the file completely automatically.

Requires connection to a P.I.O and a UART.

Supplied ready-built including 240V AC mains supply.

**Price £110 + 15% VAT + £2.00 Postage**  
**82 Chester Rd London N19**  
**Tel. 01-263 2643**

• Circle No. 293

## POWER-ONE

D.C. POWER SUPPLIES

Now, like Intel, Motorola and National you can buy Power-One open frame power supplies and enjoy quality and reliability at LOW LOW prices. Over 70 different models to choose from.

#### Floppy Disc Drive Supplies

— with connectors and cables for Shugart drives if required.

CP-249 — drives one mini drive **£33.00**

CP-323 — drives two mini drives **£60.00**

CP-205 — drives one Shugart SA800 or equivalent 8" drive **£56.00**

CP-206 — drives two SA800 **£76.00**

#### Single Output

5V at 2.7A w/OVP **£19.50**

5V at 5.4A w/OVP **£41.50**

12V at 6A **£67.50**

15V at 5.4A **£67.50**

#### Dual Output

± 12 to 15V at 1.5A **£41.00**

± 18 to 24V at 0.4A **£32.50**

± 5V at 5.4A w/OVP **£78.00**

#### Triple Output

5V, 9-15V, -5, -12, -15V at 1.8A to 10.8A From **£41.00** to **£137.00**

**SPECIAL\*** Beat this for value. TRS-80 compatible floppy disk kits — including Shugart SA 400 drive power supply and all cables. Simple drive kit **£263**. Dual drive kit **£494**.



COMPUTERS LTD.,

133 Woodham Lane, New Haw, Weybridge, Surrey  
KT15 3NJ. Telex. 8813487.

• Circle No. 294



# Jeff Orr & Graham Knott are now offering . . .

TNW 2000

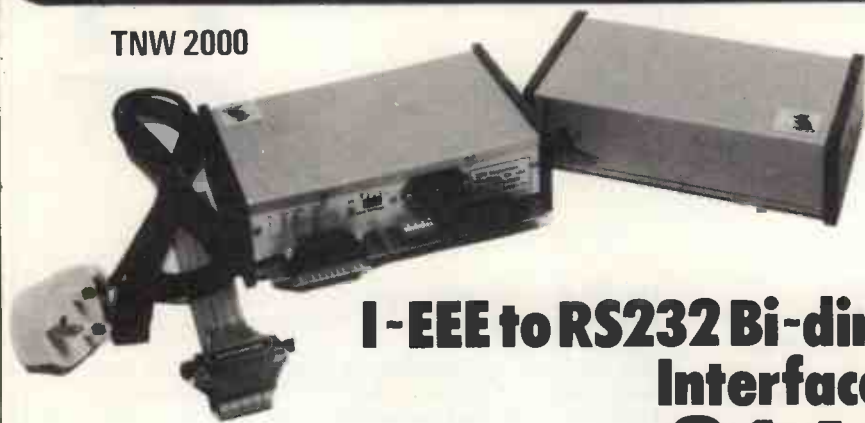

## I-EEE to RS232 Bi-directional Interface for Pet £140 plus VAT

110 Baud to 9600 Baud (switch selectable)  
I-EEE connector reproduced on rear panel for other devices  
Standard RS232 – D25 connector  
Switch selectable I-EEE address and parity  
Complete with manual and power supply

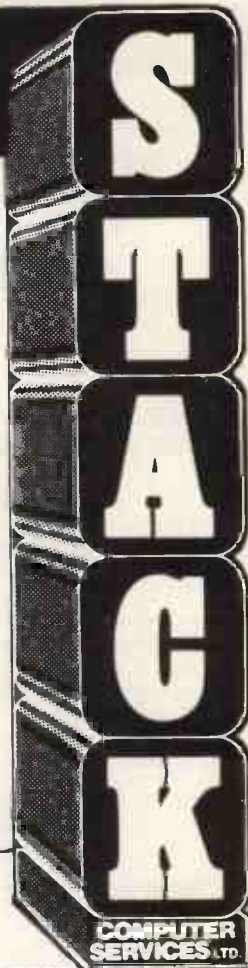

COMPUTER SERVICES LTD.

## CMC 1200

Uni-directional RS232 interface **£89** plus VAT Complete

**NEW** Vastly improved 625 TV adaptor for Pet. Handles reverse field graphics, exceptional picture. **£25 complete plus VAT**

PET		
Pet 8k		£550
Pet 16k		£675
Pet 32k		£795
2nd Cassette		£55
Disk Units		
Computhink 400k Random and Sequential complete. to fit 8k Pet (via expandamem)		£795
to fit 16/32n Pet (direct fitting)		£840
Memory Expansion		
24k Exandamem for Pet		£320
Interfaces		
Uni-direc I-EEE to RS232		£89
Bi-direc I-EEE to RS232		£140
Bi-direc 2 ported I-EEE to RS232		£175

A/D Convertors		
AIM 161 16 channel A/D convertor for Apple, Aim, Nascom etc		£130
Petset 1, AIM 161 including all interfacing requirements for Pet, complete		£166
Stack Peripherals		
Stack Joystick a balanced, calibrated unit supplied with software and examples of use, complete		£25

New 625 Video Adaptor a vastly improved 625 video convertor for Pet, works extremely well  
**£25**  
Stack Page Printer Interface copies screen contents onto 20m.a. loop complete with software **£25**

APPLE		
Apple II (colour) 16k		£985
Apple-plus (b&w) 16k		£830
ITT 2020 (colour) 16k		£950
16k RAM upgrade		£85
Printer Card		£110
Communication Card		£140
High Speed Serial Card		£110
Disk Drive with DOS		£425
Extra Disk Drive		£375
Diskettes (10's)		£30

SORCEROR		
Sorcerer 16k		£760
Sorcerer 32k		£859
AIM 65		£249.45
NASCOM		£165
KIM I		£99.95
MANUALS New Pet user manual		£5
6500 Programming manual		£5
6500 Hardware manual		£5

PRINTERS		
Teletype 43 pinfeed RS232 friction RS232		£860
pin and friction RS232		£885
Anadex DP8000		£920
		£575

Perkins Elmer Pussycat CRT copier **£839**  
Also Centronics Range, Texas Instruments, Lear Siegler  
Ring us for a quote on individual models.

### Consumables

(All paper add £5 carriage per box)  
Anadex DP8000 paper (2000 sheets) 9.5" x 11" drop **£15**  
Teletype 43 pinfeed paper (2000 sheets) 12" x 11" drop **£15**  
8.5 inch friction roll Box 'A' quality (12 x 3.5" diam rolls) **£20**  
Box 'B' quality (12 x 3.5" diam rolls) **£15**  
Box 'A' quality (6 x 5" diam rolls) **£20**  
Box 'B' quality (6 x 5" diam rolls) **£15**

### Cassettes

C15 cassettes, high quality tape, 5 screw cassette cases. per 10 **£4.40**

### Disks & Diskettes

We supply 8" and 5.25" diskettes for all disk drives. Please state your machine and we can give you a quotation.

e.g. Pet 2040	£30 per 10
Computhink	£30 per 10
Apple	£30 per 10
Horizon	£30 per 10
Sorcerer	£30 per 10

Many others in stock, both hard and soft sector.

### Connectors

Pet User Port/I-EEE Port	£1.10 each
Pet 2nd cassette Port	85p each
Hoods for User/I-EEE connectors	£2.25
D.25 RS232 Connectors (State Male or Female)	£3.00
D.25 Hoods	£2.25

### Demagnetiser

Curved head **£4.00**

If any requirements are not listed please ring us as we may have them in stock.

All prices are +VAT at 15% and include carriage (unless otherwise stated). Please make cheques payable to Stack Computer Services Ltd.

PHONE US ON

# 051-924 1125

for details of our catalogue or write

**Stack Computer Services Ltd.**  
1 Westward View, Waterloo,  
Liverpool L22 6RB

• Circle No. 295

# CADDIS (COMPUTER SYSTEMS) LTD



Suppliers of Micromputer  
Systems and Peripherals for:—

- \* EDUCATION
- \* ENGINEERING
- \* BUSINESS

- \* SCIENCE
- \* CONTROL
- \* PERSONAL COMPUTING



## WE OFFER:

PETS AT TOP DISCOUNTS e.g. 4K £414; 8K £495  
16K £608; 32K £716

NEW APPLE II 16K £810, DISC DRIVE & CONTROLLER £425  
Coming soon new PASCAL card.

EUROC Full professional business system, yet simple to use.  
12 months service included in price. £7,995.

COMPUCORP Top quality microprocessor systems with built-in floppy FROM £3,000.

TECS Prestel/Ceefax/Oracle microprocessor decoder allows editing and hardcopy via additional printer. A must for companies, conference centres etc.

CADDIS INTERFACES Full range for professional and hobbyist applications e.g. IEEE488 to RS232C; PARALLEL I/O; analogue I/O etc.

PERIPHERALS e.g. Teletype 43 £845; Decwriter 34 £875.  
SOFTWARE Full range of PETSOFT/PETAC/HIPPOSOFT Education, Games, and Business programs.

DESIGN Our team of professional engineers will design interfaces, software packages, or systems to your requirements.  
LEASING facilities available to suitable clients on any of our systems.

DELIVERY by RED STAR or SECURICOR can be arranged.

72-74 TRINITY LANE,  
HINCKLEY  
TEL. HINCKLEY (0455) 613544

ALL PRICES EXCLUDE VAT.

• Circle No. 296

# Video Vector Dynamics Ltd

**WE SELL SOLUTIONS.** Have you discovered that your problems really begin after you've bought the hardware? Either you've bought the wrong hardware or no software exists to make it work properly. We specialise in providing total solutions to problems and professional after-sales support of hardware and software. We have the resources successfully to implement commercial, scientific and instrumentation/control projects.

**COMMERCIAL.** Typical of our recent projects in this area was the connection of 12 remote stations to a central unit. This was achieved by using Commodore Pets as the remote stations allowing a degree of local processing linked via modems to a central S100 microcomputer with substantial disk storage capacity. This type of configuration is ideal where a limited amount of local accounting is required at each site but with a central collation of information on stock, payroll, etc.

**SCIENTIFIC.** Our scientific packages are currently in use by a number of major multi-national companies. Typical of these packages is our Chemical Graphics System used by pharmaceutical companies in drug design. This is designed to run on PDP-11 configuration but a subset of the facilities is available on microcomputers.

**INSTRUMENTATION/CONTROL.** We can supply a complete range of hardware and software packages covering analog, digital and graphical input/output and logging using fast microprocessor-based systems.

**COST.** Due to our familiarity with a wide range of hardware we can supply systems either optimised for minimum price or maximum performance — you decide on the price/performance mix.

In addition to consultancy and turnkey packages we offer the following proprietary products:

**FASTLIB.** This package is based on the AMD9511 arithmetic chip and is a complete hardware/software system. Use of FASTLIB is completely transparent to the user of Microsoft FORTRAN and BASIC. The software is totally integrated with the FORTRAN/BASIC compiler and simply by replacing the Microsoft-supplied library by FASTLIB existing programs can run 5 — 20 times faster without any modification. The hardware requires a single S100 slot. In addition to enhancing the speed of execution of the existing FORTRAN/BASIC functions and operations, additional functions have been implemented — NINT, TAN, ASIN, ACOS, SINH, COSH, THAN & RAN (a pseudo-random number generator).

**GLIB.** A graphics library enabling complex pictures to be produced from a series of simple subroutine calls such as: VECTOR (draws a line between any two (x,y) points); CIRCLE (draws a circle of any radius centred on any (x,y) point); TEXT (plots a 64-character ASCII set); STEXT (plots Greek and Mathematical symbols); etc. Plots can be saved on or retrieved from disk by single subroutine calls. The standard package uses the Vector Graphic High-Resolution Graphics board but the software can be configured for any graphics board or device. Microsoft FORTRAN, MACRO or BASIC is also required.

**GRAPH.** Fits either an arbitrary polynomial or a cubic spline to a set of (x,y) points. The spline routine is for drawing (smooth) curves through a series of points while polynomial finds the analytical form of the function corresponding to the (x,y) points.

**SFGC.** This is a communications program which enables connection of any two computers over a serial line (modem or dedicated). This has been used, for example, to link a microcomputer running CP/M to a PDP-11/LSI-11 running RT-11/RXS-11M and a PDP-11/LSI-11 to an IBM 370, DEC — 10 etc. mainframe.

Contact us at:

39 Hope St., Glasgow G1. 041-339-6782

• Circle No. 297

# WHY BUY A MICRO-COMPUTER FROM

# PETALECT

**ELECTRONIC  
SERVICING LTD.**

## BECAUSE

- 1) Established company trading since 1971
- 2) Electronic servicing is our speciality
- 3) We have in-house programmers/systems analysts
- 4) We have our own service engineers
- 5) We will demonstrate the PET at your premises
- 6) We can customise the PET to your requirements
- 7) We can arrange finance
- 8) We offer, after the three-month warranty, a service contract from £69.50
- 9) You benefit from our experience of having sold over 450 micro-computers to industrial, educational and business, personal users.
- 10) We specialise in programs and interfaces for weighing applications for average weight control and counting etc.



Large Keyboard PETS in stock 32K PET  
£795 + VAT 16K PET Ask for delivery on 16  
2040 Disc System and C.B.M Printers.  
Large Extension Keyboard for the PET  
£89.50 + VAT.



Petact authorised distributors for central  
Southern England for the full range of  
Computhink disc systems (dealer enquiries  
welcome)

Computhink Old ROM 400K	£795.00
" New ROM 400K	£795.00
" New ROM 800K	£995.00
	All + VAT

Specialists in applications requiring interfaces  
for electronic balances (Sartorius, Metler,  
Oertling, Salter) also instruments like Pye  
Unicam SP8 100 Spectrophotometre, other  
interfaces are available by special manufacture.

Stockists for Petact Business Systems (Sales accounting, purchase invoicing, payroll, Stock Control,  
Nominal Ledger and management information.

A wide range of Printers available i.e. Teletype 43, Anadex C.B.M., Printerm

**COMPUTER BOOKS** — for professionals, hobbyists, businessmen and newcomers.

**ACCESS, BARCLAYCARD**

We also supply: Apple II 16K, 32K or 48K, mini-disk drives, interface cards and software.

**If you require any more information or demonstration regarding the PET 2001/8 or any associated  
equipment, programs, etc., please contact Mr. P.J.A. Watts or Mr. D.W. Randall at:**

**PETALECT ELECTRONIC SERVICES LTD**

33/35 Portugal Road,  
Woking,  
Surrey.  
Tel. Woking 69032/68497

**Shop at:**

**PETALECT**  
Chertsey Road,  
Woking,  
Surrey.  
Tel. Woking 21776/23637

• Circle No. 298

# The Paper Tiger is here.



Integral Data Systems, Inc.

The Paper Tiger sets a new standard for low-cost impact printers. More capability. More versatility. For just £575.

You get a full upper and lower case 96-character set. Eight software-selectable character sizes. Plain paper, multiple copies. Forms length control. Parallel and serial interfaces. Multiple line buffer. Tractor feed. Automatic re-inking. 80 and 132 columns.

It's all standard with the Paper Tiger.

#### Unbeatable capability.

The Paper Tiger prints just about any paper form you need. From address labels to multicopy invoices and legal-size reports.

Adjust the tractor width from 1-3/4 to 9-1/2 inches. Choose from 8 switch-selectable forms lengths. Print 6 or 8 lines per inch.

#### Unmatched versatility.

Want graphics? Add the Paper Tiger's software-selectable full dot plotting graphics. Print illustrations, block letters, charts, graphs, and more.

Need a bigger buffer? The Paper Tiger features an optional 2K-byte memory that holds a full 24-by-80 CRT screen.

#### And there's more.

The Paper Tiger is small, lightweight, and compact. That's because it's designed especially to work in small computer systems.

And it's built rugged and simple. For high reliability and easy maintenance. Just like the thousands of IDS printers already in the field.

Feature	Printer	Integral Data 440	Anadex	Heathkit
Columns		132	80	132
Software Selectable Characters		8	2	3
True Tractor Drive		YES	NO	NO
Parallel and RS232 Serial Interfaces		YES	YES	NO
115-230 Volt 50-60 Hz Switch Selectable		YES	NO	YES
Full Dot Plotting Graphics		OPTION	NO	NO
Selectable 1/2-Line Increments		YES	NO	NO
Six or Eight Lines Per Inch Switch Selectable		YES	NO	YES
Software Select/Deselect		YES	NO	NO
Re-Inking Ribbon		YES	NO	NO
Power-on Diagnostics		YES	NO	NO
Automatic Paper Out Detection		YES	YES	NO
CRT Screen Buffer		OPTION	OPTION	NO
UNIT PRICE		£575	£575	£553

Comparison data from available manufacturer's literature.

#### See for yourself.

Check the comparison chart. Find out why this Paper Tiger just set a new standard for low-cost impact printers.

Whether you are a potential end-user or a dealer, why not ask for our free brochure? We will also send dealers details of our unique support service.

**Kingston Computers,**  
Scarborough House,  
Scarborough Road,  
Bridlington.  
Tel: (0262) 73036 Telex 52642  
A Member of the Dale Group of Companies



• Circle No. 299 |

# SERVICING BY PROFESSIONALS

## THE COMPANY

Kode Services Limited, part of the British-owned Kode International Group of Companies, is rapidly becoming a major U.K. service operation specialising on a whole range of equipment from basic terminals to microprocessor-based systems.

Over 100 Field Service Engineers nationwide, coupled with full depot and workshop facilities, are available to support the following equipments:

Model 33, 40, 43 TT, Lear Siegler ADM1A, 2A, 3A, ADM42 and 31, Microstar V, Anadex D8000 Printer. We have the capability to service new products and are always evaluating new DP equipment.

Fully-comprehensive maintenance contracts or a full depot repair service can be offered.

## THE CAREER

Opportunities are available for experienced professionals and gifted amateurs who have a full understanding of TTL logic and digital techniques, and wish to move into a service-orientated career applying their knowledge to the servicing of sophisticated electronic equipment.

For further details on maintenance or job prospects, please call or write to Mr C. Marklew on 0249 813771.

Kode Services Ltd.,  
Station Road,  
Calne,  
Wiltshire.

# TECHNICIANS SERVICE CASES



**FIVE** EXCITING TYPES AVAILABLE NOW  
TOOL KITS TO YOUR SPECIFICATION  
OR CASES CAN BE SUPPLIED WITHOUT  
TOOLS

Full Details From:



**A. MILLS (ACTON) LIMITED**

CHURCHFIELD ROAD, ACTON, LONDON W3 6ED

Telephone 01-992 4835/7, 01-993 2241/7

Telex 24224-305

Established 1918

• Circle No. 300

# Advertisement Index

Abel Computer Systems	30	Databank	26	Lifeboat Associates	6, 7	Rair	99
Acorn computers	98	Data Systems Engineering	162	Lion Computer Systems	21	Research Resources	40
Aculab	10	Datron Interform	46, 169	Logitek	22	Rockliffe Brothers	30
Adda	155	DDT	168	Logma Systems Design	150	Rosstronics Computer Centre	104
ADES	161	Digitas	112	London Computer Store	16, 157	SAS	166
Aim System Developments	28	Electrovalue	169	Lotus Sound	43	SEED	19
Airamco	85	Ensign Computer Systems	18, 32, 56, 157	LP Enterprises	175	Sharp Electronics	26, 27
AJD	12	Euro-Calc	134	LTT Electronics	18	Sigma Technical Press	38
Almarc	11	Factor One Computers	54	Mathematical Models	30	Sintrom Microshop	25
Alphameric	163	Four on Four	16	Metrotech	166	Sirton Products	156
Anadex	150	Ford, Alan	38, 155	Microbits	47	Slough Micro Shop	26
Analog Electronics	110	Gilbert Computers	158	Micro Centre	2	Small Systems Engineering	44
Applied Computer Techniques	15	GPW	12	Microcomputation	28	Stack	177
Audio Products	158	Graffcom	153	Micro Computer Centre	10	Stage One	174
B & B Consultants	48	Gramma (Winter)	4	Micro Control	32	Strutt	168
Bass Engineers (Sales)	104	Great Northern Computers	24	Microdigital	46, 174	Stuart, William	34
Betos	23	HAL Computers	176	Micro Facilities	162	Sumlock Bondain	158
Beyts Logic	122	Happy Memories	18	Micromedia (Systems)	50	Sumlock Electronic Services	161
BFI	170	HB Computers	42	Micronex	150	Tandy	35
BL Microelectronics	174	Heathkit	10, 14	Micropute	172	T & J Johnson (Microcomputers) Etc.	165
Caddis	178	Henry's Radio	16	Microsolve Computer Services	36	Technlogics	22
Cambridge Computer Store	20	Hitech	169	Micro Task	32	Technical Book Services	8, 9
Camden Electronics	22	Home and Business Computers		Microtrek	154	Terodec Microsystems	17
CCS	152	Icarus	49	Microwave	156	Thanet	48
Chromasonic Electronics	154	Informex	155, 170	Mills, A	181	Thistle	42
Comart	5, 86	Interam Computer Systems	37	Nasco (Sales)	39	Transam	41
Comma Computers	13	Intersystems	37	Newbear	42, 153	Tridata Micros	40
Comp Computer Components	182, 183	Intex	161	Newtronics	118	Ulster Management Centre	157
Compelec	171	Isher-woods	45	NRDC	52	U Microcomputers	14
Computastore	159	Keen Computers	100	OMB	46	V & T	176
Computerama	168	Kingston Computers	180	Online Conferences	114, 116	Video Vector Dynamics	178
Computer Bits	66	KSL	181	Orr, Tim	24	Video Terminals	172
Computer Field Maintenance	110	L & J Computers	122	Padmede	34	Vlasak	172
Computer Workshop	184	Leenshire	28	Pelco (Electronics)	38	Westrex	167
CPS (Data Systems)	176			Personal Computers	133	Xitan	35
Crofton Electronics	20			Petalect	179	Zilog (U.K.)	160
Crystal Electronics	44			Petsoft	33, 83		
				Pips	56		
				Plessey	29		
				Protechnic	24		

## TRS80 EXPANSION INTERFACE

Upgrade your system as your needs increase. Contains sockets for additional 16K or 32K RAM and a disk controller for up to 4-mini-disks. Software selectable dual cassettes can be used. Features a Centronics parallel port, real time clock, and a connector for an RS-232C interface or whatever. Requires Level-II Basic. 220/240V AC.

0 RAM £229 16K RAM £458 32K RAM £787



## ANADEX DP8000

ONLY £540 + VAT  
PET Connector — £49



The DP 8000 prints the 96-character ASCII set in single or double width at 84 lines per minute. • The unit operates bi-directionally to print a 9 x 7 matrix on multiple copy, pin-feed plain paper. • This model accepts RS-232C or current loop serial data at baud rates switchable from 110 to 9600 and Parallel Bit data input at over 1000 characters per second.

• Standard storage capacity of 256 characters • Other features include Out of Paper Detector, Top of Form Programming and Skip Over Perforation Control.

## THE NEW ITT APPLE (2020)

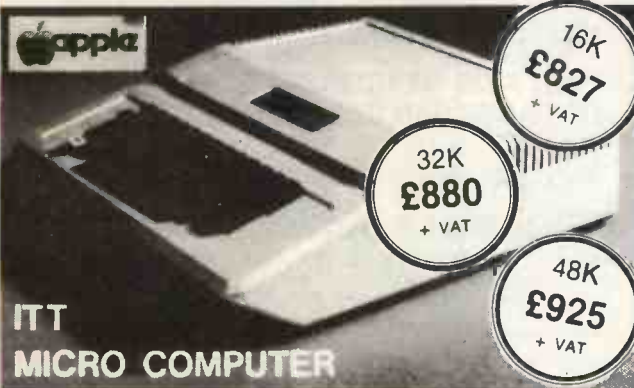

ITT MICRO COMPUTER

★ Full colour — UHF output ★ Audio cassette tape Interface ★ Up to 48K RAM on board ★ BASIC in ROM (graphics commands include COLOUR = VLIN, HLIN, PLOT and SCRIN) ★ Built in loudspeaker ★ Buckets of software available ★ Disk System (110K byte per drive — includes controller) only £425 + VAT **EX-STOCK**

## THE TRS80 (Special Scoop) Low Priced, Ready to Go!



£399 + VAT

EXTENDED WARRANTY BY COMPU CARE

PLUGS INTO YOUR OWN TV Use your own cassette

LEVEL II BASIC WITH 16K USER RAM provides you with possibly the most powerful micro around. All our TRS80s are fully converted to English Television Standard and include a U.K. Power Supply, Cassette Leads, Sample Tape, Level I & Level II programming manuals, and special lead that enables you to connect direct into your own television.

Special features of Level II Basic enable you to: — Set or reset any point on the screen — Test for the presence of a point on the screen (these features enable easy animation) — Save or load data from cassette under program control — File handling capabilities on cassette using named files. — Graphics blocks as standard — design your own pictures and many many more features for only £399 + VAT

## PET COSTS LESS AT COMP and it's a pedigree

8K — Comes complete with integral cassette deck. Full manuals supplied. Powerful 8K Microsoft Basic in ROM. Masses of software available — £499 + VAT

16K — Same as above but with new improved keyboard and cassette supplied as extra. Machine code monitor on board so you can program in 6502 machine code — £590 + VAT

32K — for a little extra get 32K memory providing greater storage capacity for programs or data — £690 + VAT

External Cassette deck for 8K, 16K or 32K — £55 + VAT complete with cable and connector.



EXTENDED WARRANTY BY COMPU CARE

## HITACHI PROFESSIONAL MONITORS



9" — £129 + VAT  
12" — £199 + VAT

• Reliability Solid state circuitry using an IC and silicon transistors ensures high reliability. • 500 lines horizontal resolution Horizontal resolution in excess of 500 lines is achieved at picture center. • Stable picture Even played back pictures of VTR can be displayed without jittering.

• Looping video input Video input can be looped through with built-in termination switch. • External sync operation (available as option for U and C types) • Compact construction Two monitors are mountable side by side in a standard 19-inch rack.

## video 100

12" BLACK & WHITE LOW COST VIDEO MONITOR



• Ideal for home, personal and business computer systems • 12" diagonal video monitor • Composite video input • Compatible with many computer systems • Solid-state circuitry for a stable & sharp picture • Video bandwidth - 12MHz + 3DB • Input impedance - 75 Ohms • Resolution - 650 lines Minimum in Central 80% of CRT; 550 Lines Minimum beyond central 80%.

Only £79 + VAT

## SORCERER SPEAKS YOUR LANGUAGE

For personal or business use. The best value for money around. • 512 by 256 point screen resolution • 16K or 32K User RAM • Centronics Parallel Port • RS232C Serial Port • Composite IV peak to peak video output T.V. output supplied as extra. • 64 programmable graphics + 64 standard PE graphics • 79 key keyboard including 16 ke numeric keypad. • Expansion bus for connection to S100 Expansion Box.

16K Sorcerer — £690.00 + VAT  
32K Sorcerer — £790.00 + VAT  
S100 Expansion Box — £210 + VAT

Word Processing Pac and Development Pac now available. Word Processing Pac — £70 Development Pac — £70



EXTENDED WARRANTY BY COMPU CARE

## Break the language barrier £138 ONLY + VAT



At a price equivalent to learning one language, LEXICON offers you, English, Spanish, French, German, Italian and Greek. The LK3000 comes to you with the person to person module which contains 6 languages, de-luxe carrying case and a charger adaptor using its own power source which will give you 4-5 hours continuous use, and can easily be re-charged from the mains supply.

wherever you may be in the world. Every additional module carries a concise and understandable instruction book. Your deluxe carrying case has room for two additional modules.



(Part of the Compshop Ltd. Group)

CompuCare is a company that has been set up to provide servicing and maintenance for the popular makes of micro-computers i.e. Sorcerer, Pet, Apple, TRS80, Nascom, CompuKit. Our charges are £7 per hour plus parts. Because of the extensive range of spare parts stocked you can usually expect your micro to be repaired within 10 days for an average charge of £14 labour. Emergency 24 hour repairs can be handled for a £10 surcharge where possible. CompuKits and Nascoms unsuccessfully constructed will be charged a standard £25. Maintenance contracts for these machines are available, see your local dealer for a CompuCare Maintenance Application Form.

Please add VAT to all prices — Delivery at cost, will be advised at time of purchase. Please make cheques and postal orders payable to COMP, or phone your order quoting BARCLAYCARD, ACCESS, DINERS CLUB or AMERICAN EXPRESS number. OPEN — 10am to 7pm — Monday to Saturday CREDIT FACILITIES ARRANGED

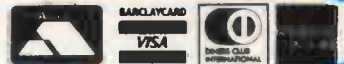

JUST COMPARE OUR CASH AND CARRY PRICES!

AS SEEN IN  
P.E. AUGUST, SEPTEMBER  
OCTOBER 1979

EUROPE'S FASTEST SELLING ONE BOARD COMPUTER —  
JUST CHECK THE SPEC'S.

SAMPLE TAPE  
WITH EXTENDED  
MACHINE CODE MONITOR  
AND DISSASSEMBLER  
INCLUDED FREE

# COMPUKIT UK101

## LOW COST SUPERBOARD IN KIT FORM

The CompuKit UK101 has everything a one board 'superboard' should have.

- \* Uses ultra-powerful 6502 microprocessor.
- \* 50Hz Frame refresh for steady clear picture (U.S.A. products with 60Hz frame refresh always results in jittery displays)
- \* 48 chars by 16 lines — 1K memory mapped video system providing high speed access to screen display enabling animated games and graphs.
- \* Extensive 256 character set which includes full upper and lower case alphanumerics, Greek symbols for mathematical constants and numerous graphic characters enabling you to form almost any shape you desire anywhere on the screen.
- \* Video output and UHF Highgrade modulator (8Mz Bandwidth) which connects direct to the aerial socket of your T.V. Channel 36 UHF.
- \* Fully stabilised 5V power supply including transformer on board.
- \* Standard KANSAS clyt tape interface providing high reliability program storage — use on any standard domestic tape or cassette recorder.
- \* 4K user RAM expandable to 8K on board £49 extra.
- \* 40 line expansion interface socket on board for attachment of extender card containing 24K RAM and disk controller. (Ohio Scientific compatible).
- \* 6502 machine code accessible through powerful 2K machine code monitor on board.
- \* High quality thru plated P.C.B. with all I.C.'s mounted on sockets.
- \* Professional 52 Key keyboard in 3 colours — software polled meaning that all debouncing and key decoding done in software.

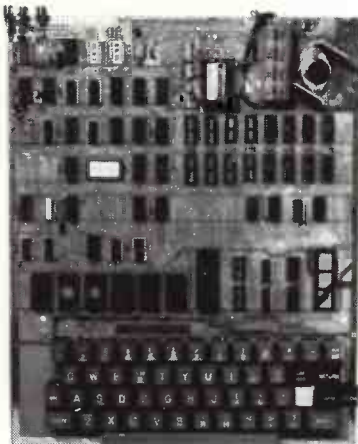

\*8K Microsoft Basic means conversion to and from Pet, Apple and Sorcerer easy. Many compatible programs already in print. SPECIAL CHARACTERS  
@ Erases line being typed, then provides carriage return, line feed.  
Erases last character typed.  
CR Carriage Return — must be at the end of each line.  
: Separates statements on . line.  
CONTROL/C Execution or pri-ning of a list is interrupted at the end of a line:  
"BREAK IN LINE XXXX" is printed, indicating line number of next statement to be executed or printed.  
CONTROL/O No outputs occur until return made to command mode. If an Input statement is encountered, either another CONTROL/O is typed, or an error occurs.  
? Equivalent to PRINT

Simple Soldering due to clear and concise instructions compiled by Dr. A.A. Berk, BSc.PhD

NO EXTRAS NEEDED JUST HIT 'RETURN' AND GO.

Build, understand, and program your own computer for only a small outlay.

KIT ONLY **£219** + VAT including RF Modulator & Power supply. Absolutely no extras.

Available ready assembled and tested, ready to go for **£269** + VAT

**COMMANDS**  
CONT LIST NEW NULL RUN  
**STATEMENTS**  
CLEAR DATA DEF DIM END FOR  
GOTO GOSUB IF GOTO IF THEN INPUT LET  
NEXT ON GOTO ON GOSUB POKE PRINT READ  
REM RESTORE RETURN STOP  
**EXPRESSIONS**  
**OPERATORS**  
+ . / . ↑ NOT AND OR > < < > > < = < = RANGE 10<sup>-32</sup> to 10<sup>+32</sup>  
**VARIABLES**  
A.B.C. ...Z and two letter variables  
The above can all be subscripted when used in an array. String variables use above names plus \$ e.g. A\$

**FUNCTIONS**  
ABS(X) ATN(X) COS(X) EXP(X)  
LOG(X) PEEK(I) POS(I) RND(X)  
SPC(I) SQR(X) TAB(I) TAN(X)  
FRE(X) INT(X)  
SGN(X) SIN(X)  
USR(I)  
**STRING FUNCTIONS**  
ASC(X\$) CHR\$(I) FRE\$(X\$) LEFT\$(X\$,I)  
RIGHT\$(X\$,I) STR\$(X)  
LEN(X\$) MID\$(X\$,I,J)  
VAL(X\$)

### EXTRAS AVAILABLE SOON

**COLOUR ADD-ON** enables you to choose your foreground and background colour anywhere on the screen. Flash any character on the screen at will. Full documentation and parts in kit form.

**AD-A-RAM EXTENDER CARD** provides up to 32K Dynamic RAM Expansion, 8 Eprom sockets for 2708's or 2716's. Parallel Port (electronics compatible) and an RS232C serial port.

## WIN YOURSELF AN ANADEX DP8000 LINE PRINTER

There's never enough good software around. That's why **COMPUKIT LTD.** are sponsoring a software contest. There are 2 categories:

- 1) **Business and Education**
- 2) **Fun and Games**

One lineprinter will be awarded to the winner of each category.

Send or bring along to the address shown below the following:

- 1) The program on cassette in the format used by the **COMPUKIT UK101**
- 2) Any documentation that you have for the program (source listing not necessary)
- 3) This coupon signed by you accepting the rules and conditions of the competition.

**RULES:**

- 1) Entries, including documentation, must be printed by computer or typed double spaced, with your name on every page.
  - 2) Send or bring your entries to the address shown below.
  - 3) Entries must be received by midnight on 29/2/80, any received after this time are void.
- Winners will be notified by post before 31/3/80.  
You warrant by your signature that all programs and documentation material included is entirely your own creation, and that no rights to it have been given or sold to any other party, and you agree to allow **COMPUKIT LTD.** to use, publish, distribute, modify, and edit it as it sees fit.

- 5) All entries become the property of **COMPUKIT LTD.** No entries will be returned nor any questions answered regarding individual entries.
- 6) Judging will be by a selected panel chosen by, and including representatives of **COMPUKIT LTD.** Judges may assign programs to any of the categories as they see fit. Decision of the judges is final.
- 7) Employees of **COMPUKIT LTD.**, its dealers, distributors, advertising agencies and media are not eligible to enter.

Name \_\_\_\_\_

Address \_\_\_\_\_

I agree to abide by the above mentioned rules.

Signature \_\_\_\_\_

**COMP** COMPUTER COMPONENTS

14 STATION ROAD, NEW BARNET, HERTFORDSHIRE TEL: 01-441 2922 (Sales)  
CLOSE TO NEW BARNET BR STATION — MOORGATE LINE 01-449 6596  
OPEN — 10am to 7pm — Monday to Saturday TELEX: 298755



All Products Ex-Stock Please check availability

(Part of the Compshop Ltd. Group)

# SWTPc S/09

## MICRO OR MAINFRAME?

The definitions are becoming blurred. There used to be ways of telling them apart, such as the word size, the direct memory addressing capability, the number of addressing modes and instructions of the processor, or even by the number of peripherals attached.

We are not sure about our new S/09 so we're just going to call it a computer system and let you judge for yourself.

- Direct addressing of up to 768K bytes RAM—No bank switching necessary.
- Motorola 6809 processor uses both 8- and 16-bit instructions and with its 10 addressing modes allows the use of modern programming techniques such as position independent code, re-entrancy and recursion.
- Dynamic memory management system can allocate available RAM in as small as 4K blocks.
- Both Multi-user and Multi-tasking/Multi-user operating systems available.
- Scientific BASIC and Business BASIC, PASCAL, PILOT, Assembler, Editor, and DEBUG programs available. FORTRAN to be released shortly.
- Business BASIC includes Virtual Array, Record I/O, and Index Sequential file handling and 14 significant digit accuracy.
- 3-day Industrial Training Courses by Cambridge Microprocessor Courses at Cambridge University Engineering Department available now, including 'hands-on' use on 10 SWTPc 6809 systems.
- Expandable from a 5in. Dual Minifloppy Disc-based system for less than £2,000 to a massive multi-user configuration for under £40,000.

What you can get for under £40,000.

S/09 Computer System with 768K RAM.  
65 Million character Disc Storage.  
10 Intelligent Terminals with built-in graphics and 'soft' keys.  
2 Daisywheel Printers.  
2 Intelligent 132-column Printers.  
2 80-column Printers.



**Southwest Technical Products Co.**

---

38 DOVER STREET · LONDON · W1X 3RB · Telephone: 01-491 7507 · Telex: 268913